



TECHNICAL 021EN **ekinex**

.....  
INTRODUCTION  
.....

The Company	07
The automation of buildings	09
The KNX standard	10
The advantages	12
The Ekinex® devices	15





## We believe

**in technology that makes life easier.**

We develop devices that make everyday gestures easier.

Our scenario is the whole world.

## We want

**to combine technology and design.**

To give life to something unique that combines

two seemingly distant worlds.





## The Company

### Technology meets design.

We offer a form without ever leaving aside its content. We present a product with a strong technological content which is also cutting edge from an aesthetic point of view. Design becomes the driving force behind technology, the key to opening our doors to the world of smart homes. We use the potential of the KNX system to guarantee high quality standards for a project we have called Ekinex®.

### Our devices are developed and manufactured in Italy.

Ekinex® has created a line of objects that encloses the essence of the Made in Italy: design, attention to detail, technological innovation and advancement. Designed for a global market, Ekinex® products are an expression of the new Italian tradition, which combines the attention of craftsmanship in the creation of the product to high technological levels. Ekinex® supports the idea of a design that is not just an aesthetic exercise, but one that understands, as fundamental factors, ease of use, immediate understanding of the function and the balanced and intelligent application of technology.



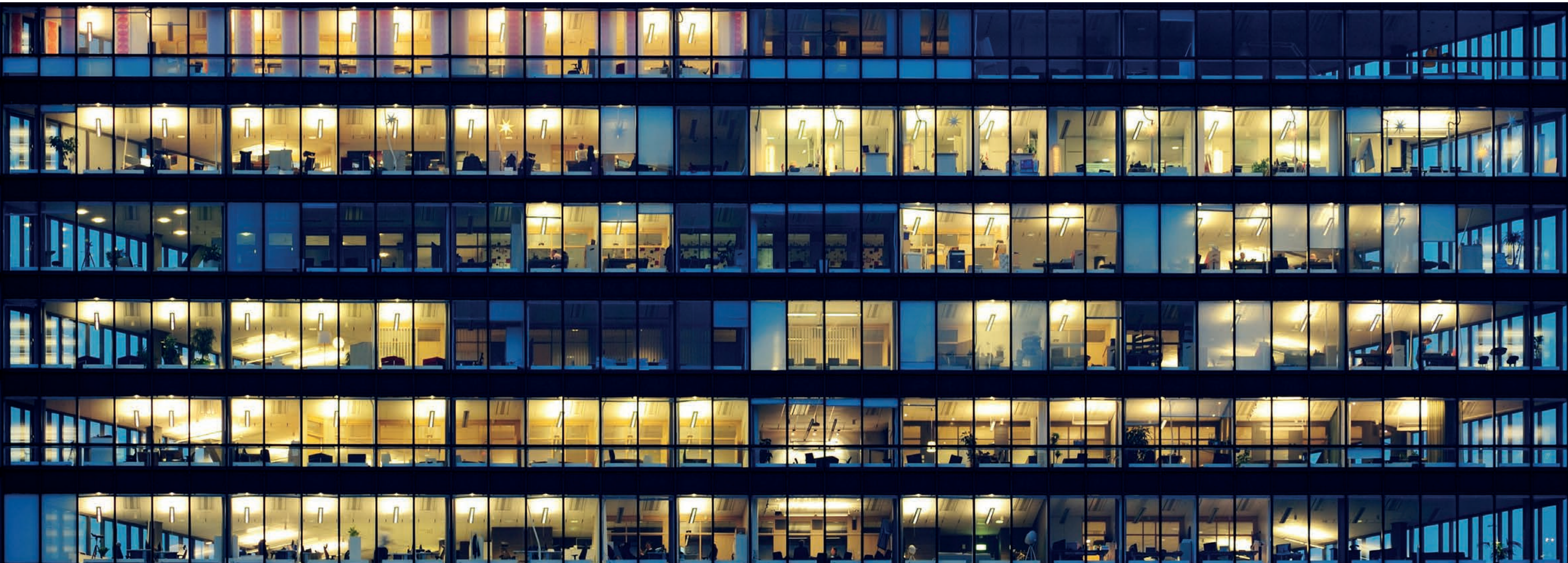

## The automation of buildings

**Ekinex® is an intelligent system for controlling homes and buildings, developed in accordance with the open KNX standard.** Having an Ekinex® system means **to increase comfort and safety, reduce energy consumption and raise the long-term value of a building** using products characterized by fine aesthetics and a great simplicity of use.

**Setting up an Ekinex® system is easy:** a signal network is arranged at project level, reaching all those areas where commands, sensors or loads to be system-controlled are expected. The arrangement, achieved by means of a simple signal cable, represents an authentic network for the exchange of information between Ekinex® devices.

The scalability, typical of Ekinex® building control systems, even allows to start off with a basic equipment, both in terms of functions and devices, which may be extended at a later stage, depending on individual requirements, the location's infill and economic availability. **The investment is quickly paid back, and is protected in time.** Thanks to the native openness and interoperability of the KNX standard, the system can even integrate functions that may not be available within the Ekinex® range of products.





**500** MEMBERS  
**30** YEARS OF EXPERIENCE  
**45** NATIONAL GROUPS  
**8000** PRODUCTS  
**98000** PARTNERS IN 172 COUNTRIES  
**500** TRAINING CENTRES IN 73 COUNTRIES

## The KNX standard

Great developments in the field of home and building automation were made possible especially thanks to an open, modular and interoperable standard like KNX. This innovative standard was born from the merging of three European systems (EIB, BatiBUS and EHS), developed and brought to the market in the early 90's. The diffusion of the system was facilitated by an intense work of cooperation at normative level in the standard committee at European level. For this reason, too, **KNX is a standard characterized by a total conformity with norm EN 50090** on electronic systems for the control of homes and buildings (HBES, Home and Building Electronic Systems).

The twenty-year presence on the market of this standard offers the best guarantee in terms of reliability and consolidation of the technology used. The openness of the standard and that of the KNX Association, on the other hand, ensure availability of products in the long run and a constant development, both in terms of technology and offering of products, functions and applications.

The vitality of KNX proposals is witnessed by the sustained expansion of the association, seeing the entry of manufacturers, coming from many different areas, and from the tens of thousands of technicians who chose it to specialize in the field of building automation.

### Achievable savings with the adoption of the KNX system for Home & Building control:

- 40% over shutters control**
- 50% over individual ambient control**
- 60% over ambient lighting control**
- 60% over ventilation control**

**For customers, the variety and availability of KNX products has no comparison in other technological areas**, and the system openness translates into the highest free choice, thereby avoiding the disadvantageous dependence of having to buy from a single supplier. Thanks to the modularity of the system, a project can be extended in time, starting with a basic configuration and adding more functions later. **The native interoperability of KNX products is fundamental to technicians**, as it allows to design a system by always choosing the most suitable technical options, reducing compromise and ties caused by isolated systems which do not converse with one another. **Moreover, the system offers new professional opportunities to designers and system integrators, making it possible to receive a consistent and high-level technical training and become certified KNX Partners.**



The KNX standard is entirely compliant with norm EN 50090 on HBES (Home and Building Electronic Systems) systems)



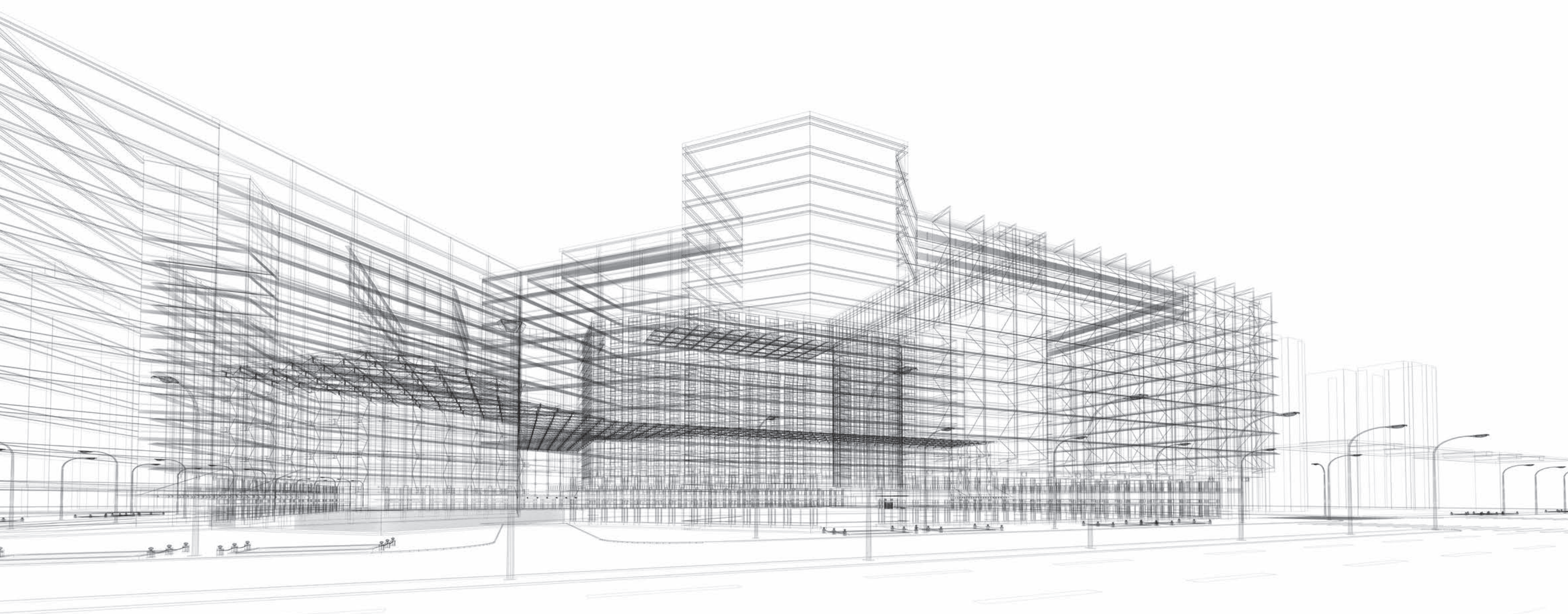

## The advantages

Design, realize and use a home & building control plant with the KNX system has many advantages.

### Designer

- Compliant, open, interoperable system
- Can be used in all types of buildings, from small residential to large service industry ones
- Devices, from over 300 manufacturers, communicating between each other in native mode
- Constant expansion of available functions and applications
- System design by means of standard software (ETS), manufacturer-independent
- Easy realization of commands, controls, supervisions and displays
- Wide availability of complex logic
- Interfacing towards numerous other systems, protocols and standards
- Simple logic connections between functions and devices
- Large choice of device parametrizing options based on single requirements
- Reduction of building's fire load
- Certified training, standardized and available worldwide

### Installer

- Reduced device assembly and cabling times
- Unique, fast connection system (cable and bus terminal block) for all manufactures
- High quality and reliability of products (consolidated system)
- Configuration and service commissioning by means of standard, manufacturer-independent software (ETS)
- Speed and flexibility in the expansion and the modification of use
- Remote access for maintenance and diagnosis interventions
- Reduction of cables needed for command, control and distribution circuits
- Certified training, standardized and available worldwide
- Opportunities for professional advancements
- Access to the world of innovative systems

### User

- Large choice of products
- High comfort, great operation safety
- More information, verification of own consumption habits
- Coordinated working of all building systems
- Multifunctional deployment of several devices
- System scalability and modularity
- Easy upgrading, without needing interventions on cabling nor masonry works
- Independence from single manufacturer
- More efficient building energy class (as per EN 15232)
- Easy system adaptations in case of changing needs
- Time-protected investment (open system)
- Building increase in value





## The Ekinex® devices

The range of Ekinex® KNX devices includes system devices, devices dedicated to single application functions and accessories. System devices allow basic operation of the bus system, while the devices dedicated to single application functions are developed specifically to execute the command, control and/or monitoring the technical systems in the building, like lighting, heating or shading.

They include switching, control and display units, sensors and actuators, etc. Each device is fitted internally with a communication module linking to the KNX bus. All devices are realized in multiple mounting versions (protruding or recessed walls, electric cabinets or panels on DIN rails as per EN 60715) in accordance with their destination of use and with the main installation modality. The KNX certification guarantees the interoperability among the devices of different KNX manufacturers. The entire procedure is disciplined by the certification system developed by the KNX Association and is based on conformity tests carried out by third-party laboratories. The tests verify that the devices support the KNX protocol and that any information is coded in accordance with KNX specifications

The presence of a KNX trademark on Ekinex® devices is a guarantee for the customer:

- Ekinex® respects the quality management system in accordance with ISO 9001;
- The devices are compliant with the European norm EN 50090-2-2, concerning fundamental aspects like electromagnetic compatibility, electrical safety and environmental conditions of use;
- They comply with indications in volumes 3 and 6 of KNX specifications;
- They comply with KNX interoperability requirements concerning standardized data type and functional blocks.



# WALL-MOUNT DEVICES

<b>20venti series</b>	<b>19</b>
Pushbuttons	27
<b>FF series</b>	<b>31</b>
Pushbuttons	45
Room thermostats	53
Touch&See displays	61
<b>Sensors</b>	<b>65</b>
Movement sensor	66
Presence sensor	67
<b>71 series</b>	<b>71</b>
Pushbuttons	85
Room thermostats	93
Multisensors	96
<b>Access control</b>	<b>101</b>
Card reader	102
Card holder	103
Cards programmer and Accédo software	104
Tosibox®	106
Rockers	108
Sockets	115
Plates and frames	129
Colour solutions	151
Fenix NTM®	152
Orders and symbols	153



**20**  
VENTI

WALL-MOUNT DEVICES  
**SERIES**

Deep	22
Surface	24









## 20venti - Deep

WALL-MOUNT DEVICES - 20VENTI SERIES

**Intuition, flexibility and continuous growth.** 20venti series in its Deep version represents an evolution of the compact and essential design of 71 series, enriched with new features that facilitate the recognition of functions from the first use. The materials used are plastic, metal and the nanotechnological Fenix NTM®.

### Available colour solutions

		Deep	Surface
Plate	Plastic	•	–
	Metal	•	•
	Fenix NTM®	•	•
Rockers	Plastic	•	•

For more information see page 161

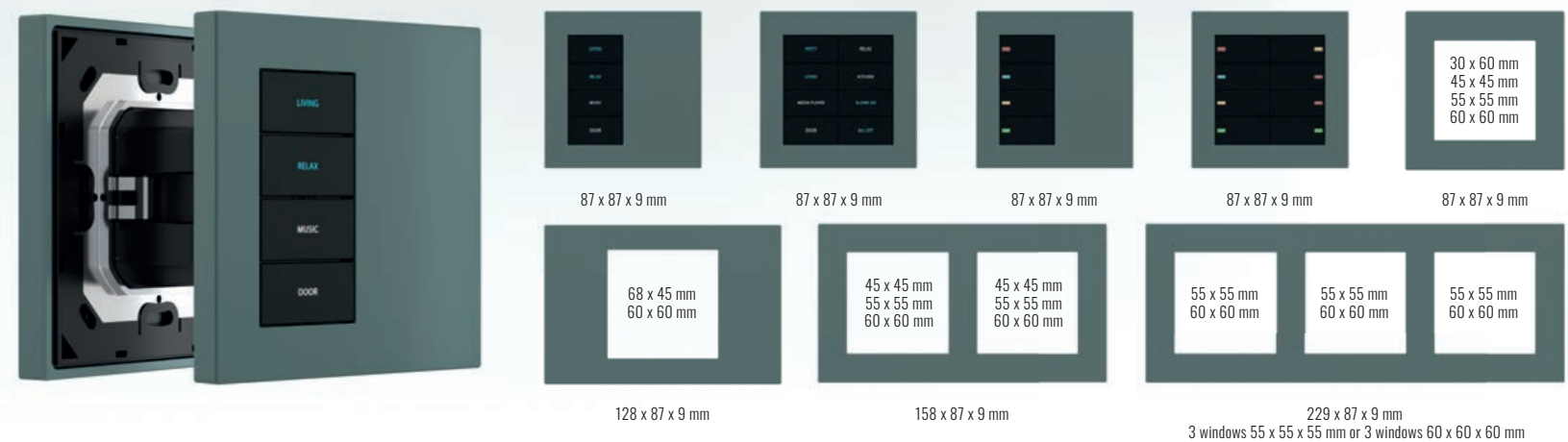



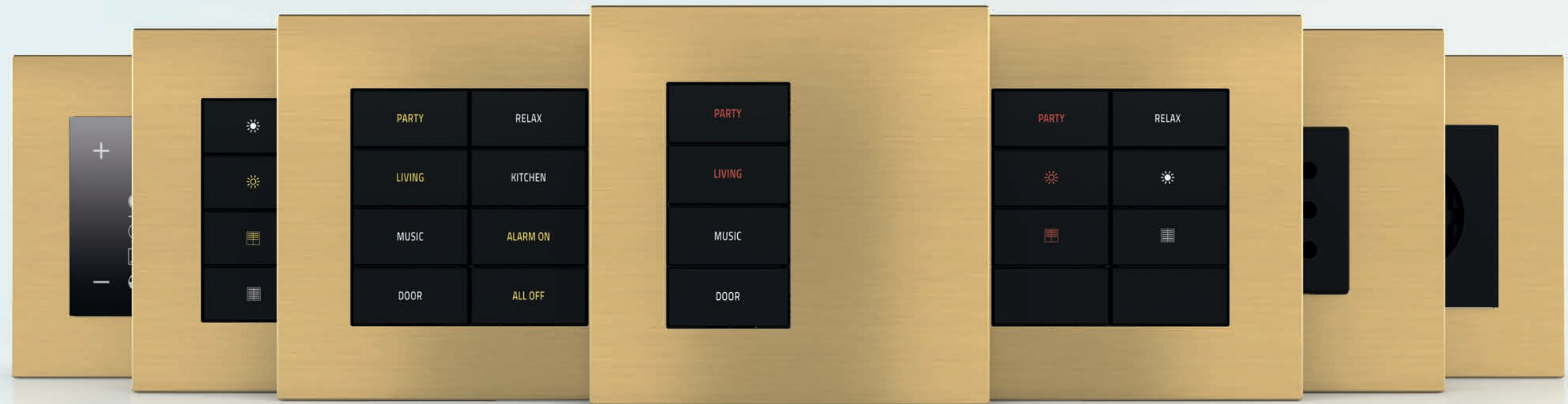

## 20venti - Surface

WALL-MOUNT DEVICES - 20VENTI SERIES

**Essentiality and functionality in a single product.** 20venti series in its Surface version represents an evolution of the compact and essential design of 71 series but is enriched with new features that make it easier to recognize the functions of the keyboard from the first use. KNX technology combined with a range of metal and Fenix NTM® finishes make the Surface 20venti series a contemporary proposal that finds its place in home, office and hotel settings.

### Available colour solutions

		Deep	Surface
Plate	Plastic	•	-
	Metal	•	•
	Fenix NTM®	•	•
Rockers	Plastic	•	•

For more information see page 161



98 x 98 x 3 mm

98 x 98 x 3 mm

98 x 98 x 3 mm

98 x 98 x 3 mm

30 x 60 mm  
45 x 45 mm  
55 x 55 mm  
60 x 60 mm

68 x 45 mm  
60 x 60 mm

45 x 45 mm  
55 x 55 mm  
60 x 60 mm

45 x 45 mm  
55 x 55 mm  
60 x 60 mm

98 x 98 x 3 mm

133 x 98 x 3 mm

168 x 98 x 3 mm



# Pushbuttons - 20venti series

WALL-MOUNT DEVICES

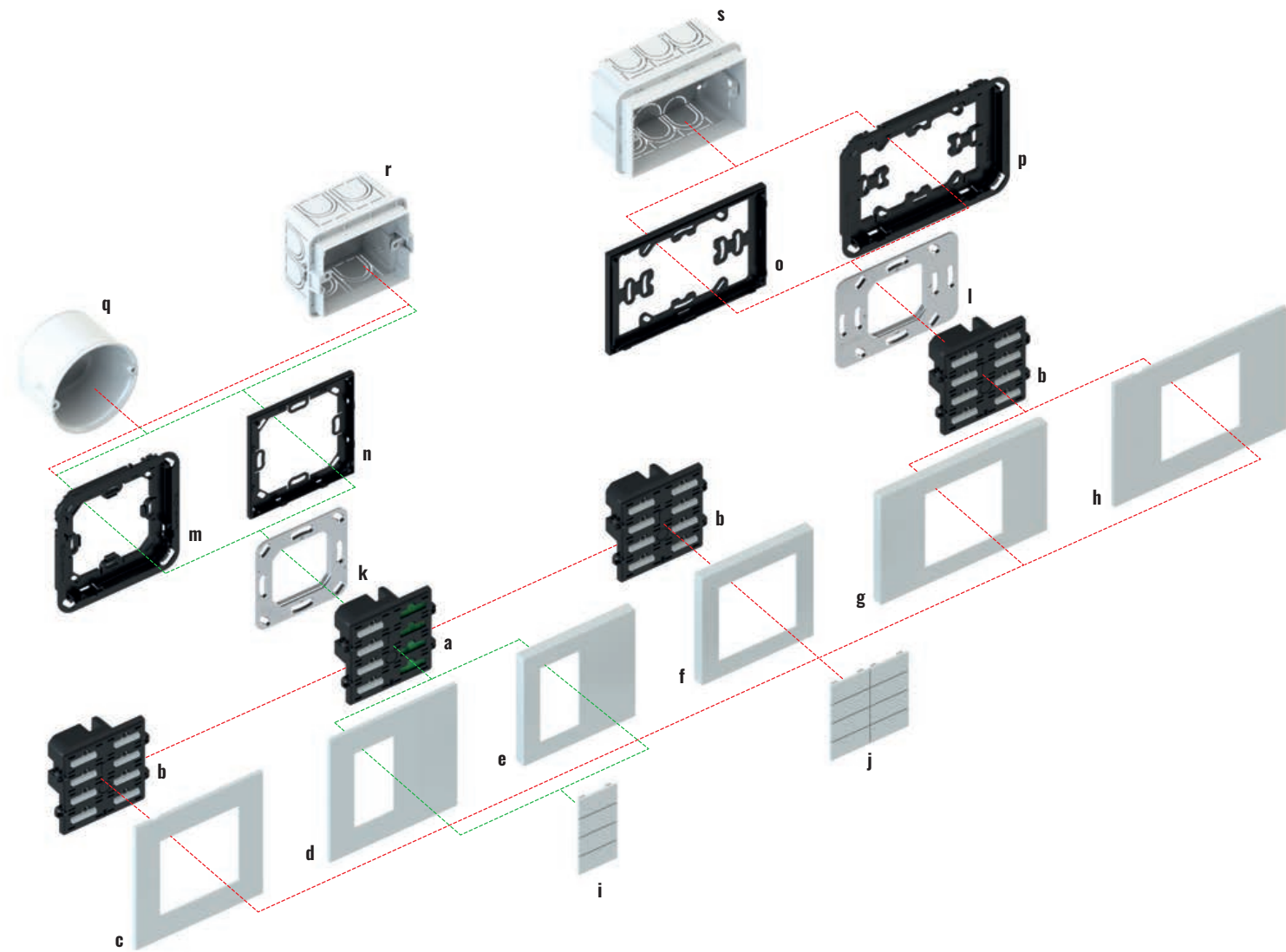

**A wider range of combinations and features.**  
The 20venti series pushbuttons are available on Deep and Surface plates with 4 or 8 rockers modularity and built-in RGB LEDs to create any colour shade. Buttons with 5 or 10 rockers modularity are also available for dimming lights or managing shutters.

The Ekinex® 20venti pushbuttons' series controls offer the possibility of numerous variants to meet the most diverse requirements. The basis is represented by the pushbutton that contains a KNX communication module inside. The EK-E20-TP-... (a, b) is suitable both for mounting on a round (q) or square (r) wall-mounting box with fixing holes with 60 mm centre distance, and for mounting (b) on a 3-place Italian standard (s) rectangular wall-mounting box with fixing holes with 83.5 mm centre distance. Each pushbutton is supplied with a metal mounting bracket (k, l) which, if necessary, can also be ordered separately: a plastic adapter and a bus line connection terminal complete the supply.

The button must be completed with the buttons and a plate from the Deep or Surface series (c, d, e, f, g, h). The buttons are available in rectangular shape (i, j), in plastic material. The button has integrated RGB LEDs that can be freely programmed: for example, for status indication or as a night orientation light. The device also offers the function of a room thermostat, thanks to the integrated temperature sensor. The integrated proximity sensor (optional in the LED version) ensures maximum readability when using the push-button panel and allows visual comfort during the night.

The devices are configured and commissioned using the ETS® software; the relevant application programs can be downloaded from [www.ekinex.com](http://www.ekinex.com).

**Pushbuttons 20venti series with backlit text/symbols and proximity sensor (4/8 rockers)**

Description	Code	Page
a) Pushbuttons 20venti series with backlit text/symbols and proximity sensor 4 rockers	EK-E20-TP-4TS-P	30
b) Pushbuttons 20venti series with backlit text/symbols and proximity sensor 8 rockers	EK-E20-TP-8T-P	31
c) Square plate Surface series (60 x 60 mm window)	EK-SQS-...	143
d) Square plate Surface series (30 x 60 mm window)	EK-SQT-...	143
e) Square plate Deep series (30 x 60 mm window)	EK-DQT-...	139
f) Square plate Deep series (60 x 60 mm window)	EK-DQS-...	139
g) Rectangular plate Deep series (60 x 60 mm window)	EK-DRS-...	140
h) Rectangular plate Surface series (60 x 60 mm window)	EK-SRS-...	144
i) Rectangular rockers (4 pcs)	EK-T4R-20-BT...	113

Description	Code	Page
j) Rectangular rockers (8 pcs)	EK-T4R-20-BT...	113
k) Metal mounting support	EK-SMQ-71	153
l) Metal mounting support with adapter**	EK-SMR-71	153
m) Adapter for square Surface plate	EK-TAS-Q-...-NF	143
n) Adapter for square plate 'NF and Deep series	EK-TAQ-...-NF	136-139
o) Adapter for rectangular plate 'NF and Deep series	EK-TAR-...-NF	137-140
p) Adapter for Surface rectangular plate	EK-TAS-R-...	144
q) Round flush-mounting box	not delivered by Ekinex®	-
r) Square flush-mounting box	not delivered by Ekinex®	-
s) Rectangular flush-mounting box (3 modules)	not delivered by Ekinex®	-

\*\*) Included with the purchase of the related 20venti series pushbutton







## 4/8-fold pushbutton with backlit text/symbols and proximity sensor - 20venti series

WALL-MOUNT DEVICES

### Description

The Ekinex® 20venti series 4/8-fold pushbutton is used for on/off control of utility devices, dimming of luminaires, control of motorized drives for roller shutters or other programmable control functions. Thanks to the integrated temperature sensor, the button can act as a temperature controller for a room or zone. RGB LED for each rocker. The switch has an integrated KNX bus communication module and is designed for installation in a flush-mounted wall box.

### Main features

- 4/8 fold version (possibility to configure up to 4 or 8 independent functions)
- RGB LED for each freely programmable rocker
- Integrated temperature sensor
- Integrated proximity sensor
- Room thermostat function
- Plastic casing
- Connection to bus line with KNX terminal block
- Wall-mounting installation on round or square wall box
- IP20 protection degree (installed)

### Technical data

- 30 Vdc power supply by KNX bus
- Current consumption from bus < 17 mA

### Products included

Delivery includes a terminal block for connection to the bus, a metal support for installation onto round or square mounting box (fixing holes 60 mm apart), a plastic adapter and two pairs of fixing screws.

### Accessories

The following accessories are available to be ordered separately:

- 4 or 8 rectangular 30 x 15 mm plastic rockers with or without backlit text/symbol
- square plate of the Deep and Surface series with 30 x 60 mm or 60 x 60 mm window

### Dimensions [mm]

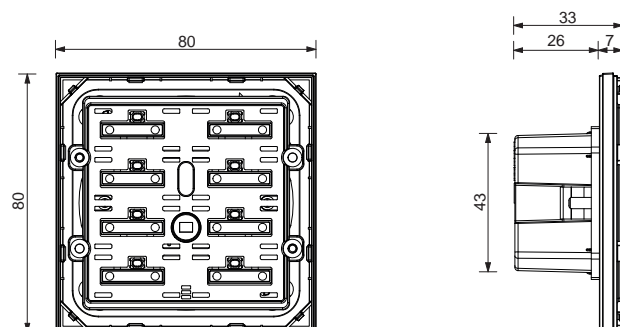

### Order information

Code	LED colours	Mounting	Rockers
EK-E20-TP-4TS-P	RGB	without frame	4 left with backlit text/symbols
EK-E20-TP-4TD-P	RGB	without frame	4 right with backlit text/symbols
EK-E20-TP-8T-P	RGB	without frame	8 with backlit text/symbols



### Configuration and commissioning

By means of ETS5 software or later versions  
Application program: **APEKE20TP##.knxprod**  
(## = version, download from [www.ekinex.com](http://www.ekinex.com))



### Documentation

For more information, see the **STEKE20TP\_EN.pdf**, technical sheet available for download from [www.ekinex.com](http://www.ekinex.com)



## 8-fold pushbutton with backlit text/symbols and proximity sensor for rectangular wall-box - 20venti series

WALL-MOUNT DEVICES

### Description

The Ekinex® 20venti series 8-fold pushbutton is used for on/off control of utility devices, dimming of luminaires, control of motorized drives for roller shutters or other programmable control functions. Thanks to the integrated temperature sensor, the button can act as a temperature controller for a room or zone. RGB LED for each rocker. The switch has an integrated KNX bus communication module and is designed for installation in a flush-mounted wall box.

### Main features

- 8 fold version (possibility to configure up to 8 independent functions)
- RGB LED for each freely programmable rocker
- Integrated temperature sensor
- Integrated proximity sensor
- Room thermostat function
- Plastic casing
- Connection to bus line with KNX terminal block
- Wall-mounting installation on round, square or rectangular wall box
- IP20 protection degree (installed)

### Technical data

- 30 Vdc power supply by KNX bus
- Current consumption from bus < 17 mA

### Products included

Delivery includes a terminal block for connection to the bus, a metal support for installation onto round or square (fixing holes 60 mm apart) or rectangular 3 seater mounting box according to the Italian installation standard provided (fixing holes 83,5 mm apart), a rectangular adapter and two pairs of fixing screws.

### Accessories

The following accessories are available to be ordered separately:

- 8 rectangular 30 x 15 mm plastic rockers with or without backlit text/symbol
- square plate of the Deep and Surface series with 60 x 60 mm window

### Dimensions [mm]

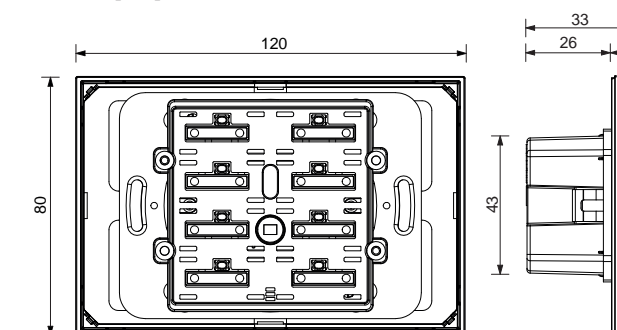

### Order information

Code	LED colours	Mounting	Rockers
EK-E20-TP-8T-P-R	RGB	without frame	8 with backlit text/symbols



### Configuration and commissioning

By means of ETS5 software or later versions  
Application program: **APEKE20TP##.knxprod**  
(## = version, download from [www.ekinex.com](http://www.ekinex.com))



### Documentation

For more information, see the **STEKE20TP\_EN.pdf**, technical sheet available for download from [www.ekinex.com](http://www.ekinex.com)





**FF**

WALL-MOUNT DEVICES

**SERIES**

Form	34
Flank	36
*NF	38
Deep	40
Surface	42









## FF - Form

WALL-MOUNT DEVICES - FF SERIES

**Simple and linear.** An essential form that suggests an idea of reliability and rigour. The line Form of the FF series has a plastic or metal range of pushbuttons, touch-displays, plates for sockets and integrated LEDs with adjustable light intensity in blue/green or white/red colour combinations. The different finishes can be freely combined with each other.

### Available colour solutions

	Form	Flank	'NF	Deep	Surface
Plastic	•	•	•	-	-
Metal	•	•	•	•	•
Fenix NTM®	•	-	•	•	•

For more information see page 161

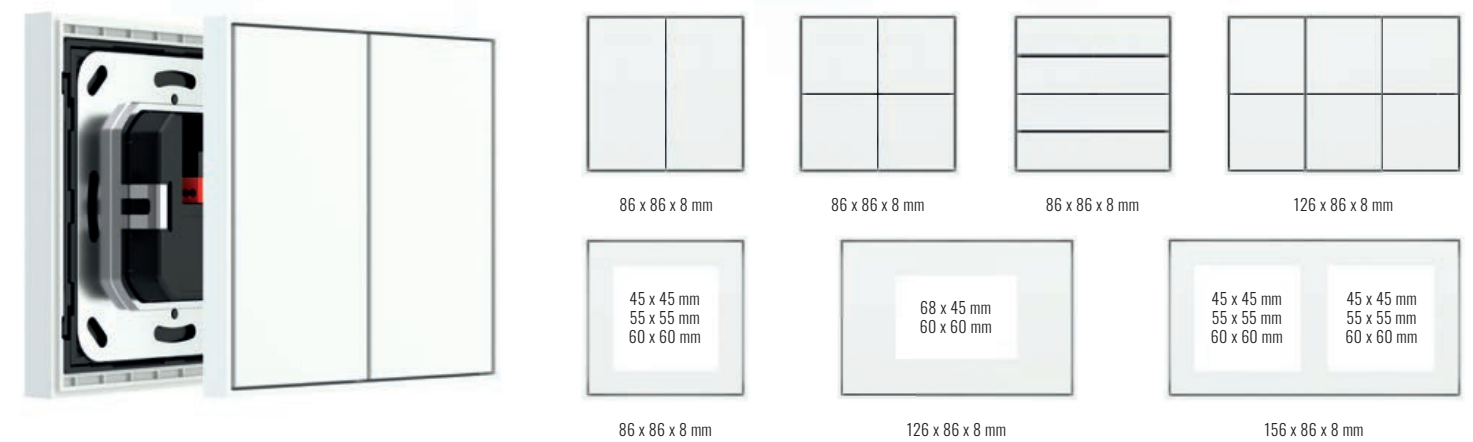





## FF - Flank

WALL-MOUNT DEVICES - FF SERIES

**Minimal and rigorous.** The simplicity of the shapes makes it adaptable to any setting. Distinguishable by its characteristic side edges, the Flank line of the FF series has plastic or metal pushbuttons, thermostats and plates for sockets in many colours, which can be freely combined according to your taste and needs.

### Available colour solutions

	Form	Flank	'NF	Deep	Surface
Plastic	•	•	•	-	-
Metal	•	•	•	•	•
Fenix NTM®	•	-	•	•	•

For more information see page 161



94 x 80 x 8 mm

94 x 80 x 8 mm

94 x 80 x 8 mm

134 x 80 x 8 mm



94 x 80 x 8 mm

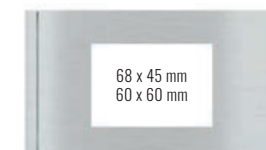

134 x 80 x 8 mm

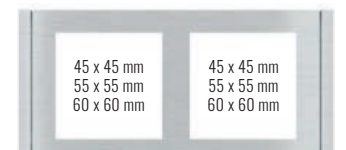

165 x 80 x 8 mm





**FF - 'NF**  
WALL-MOUNT DEVICES - FF SERIES

**Essential geometry in forms and a decisive trait.** More than ever less is more. The range of pushbutton controls of the FF 'NF series and its accessories offer the possibility to create numerous variants to meet the most different needs. Finishes in plastic, metal or Fenix NTM® for switches, thermostats and frameless sockets.

**Available colour solutions**

	Form	Flank	'NF	Deep	Surface
<b>Plastic</b>	•	•	•	-	-
<b>Metal</b>	•	•	•	•	•
<b>Fenix NTM®</b>	•	-	•	•	•

For more information see page 161



80 x 80 x 8 mm



80 x 80 x 8 mm



80 x 80 x 8 mm

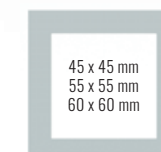

45 x 45 mm  
55 x 55 mm  
60 x 60 mm

80 x 80 x 8 mm



68 x 45 mm  
60 x 60 mm

120 x 80 x 8 mm



45 x 45 mm  
55 x 55 mm  
60 x 60 mm

45 x 45 mm  
55 x 55 mm  
60 x 60 mm

151 x 80 x 8 mm





## FF - Deep

WALL-MOUNT DEVICES - FF SERIES

**Versatile and suitable for any setting.** The Deep line of the FF series has plastic, metal and Fenix NTM® pushbuttons, thermostats and plates for sockets in numerous colours and sizes and integrated LEDs with adjustable light intensity in blue/green or white/red colour combinations. Versatile and compact, it lends itself to various combinations and matches all interior designs

### Available colour solutions

	Form	Flank	'NF	Deep*	Surface
Plastic	•	•	•	-	-
Metal	•	•	•	•	•
Fenix NTM®	•	-	•	•	•

For more information see page 161

\*) In the FF-Deep we suggest the use of the pushbuttons and room thermostats of the FF-'NF' series

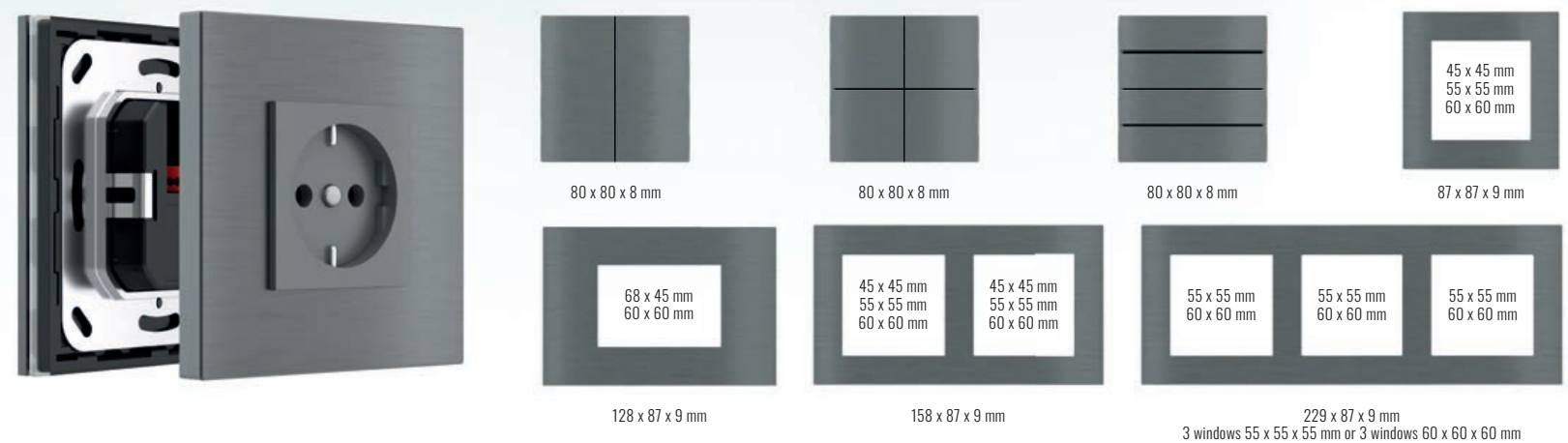



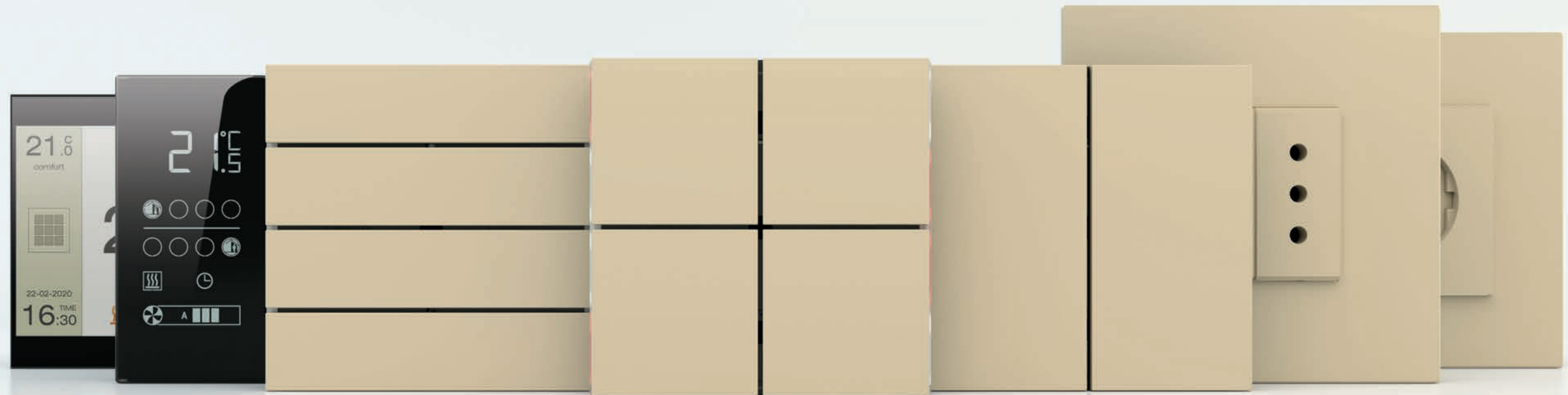

## FF - Surface

WALL-MOUNT DEVICES - FF SERIES

**Compact and essential.** Creates a continuum with the wall in a few millimetres of thickness. The Surface line of the FF series brushes the surfaces to create an effect of uniformity between button and wall. Declined in two materials with a strong personality, metal and Fenix NTM®, finds its ideal place in all the rooms of the contemporary home.

### Available colour solutions

	Form	Flank	'NF	Deep	Surface*
<b>Plastic</b>	•	•	•	-	-
<b>Metal</b>	•	•	•	•	•
<b>Fenix NTM®</b>	•	-	•	•	•

For more information see page 161

\*) In the FF-Surface we suggest the use of the pushbuttons and room thermostats of the FF-'NF' series

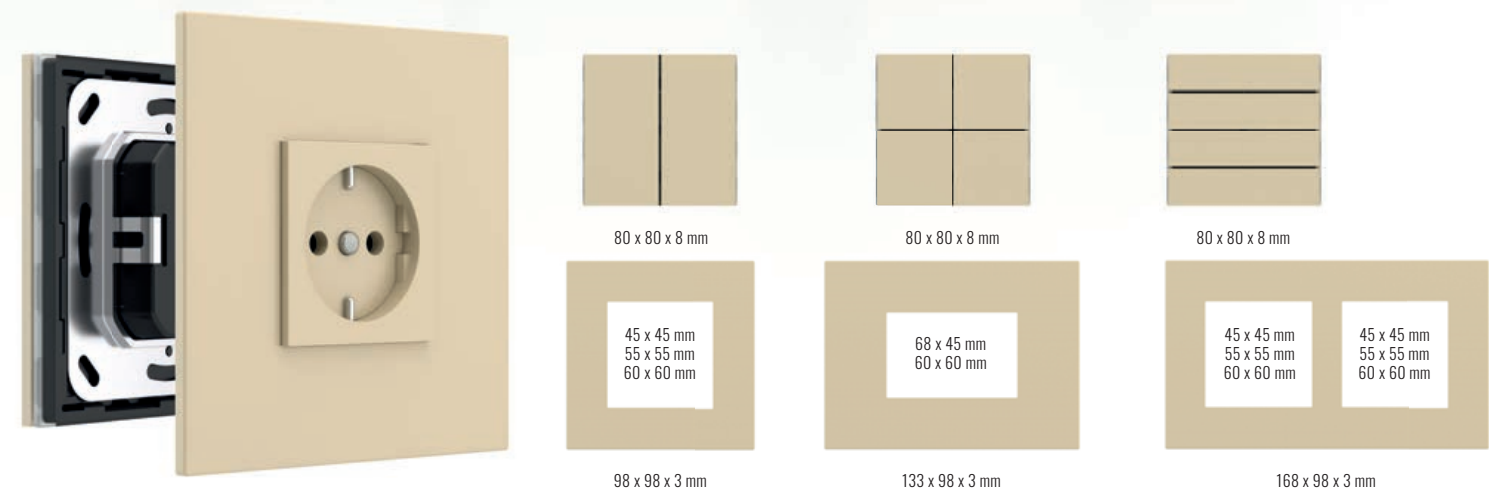



## Pushbuttons - FF series

WALL-MOUNT DEVICES

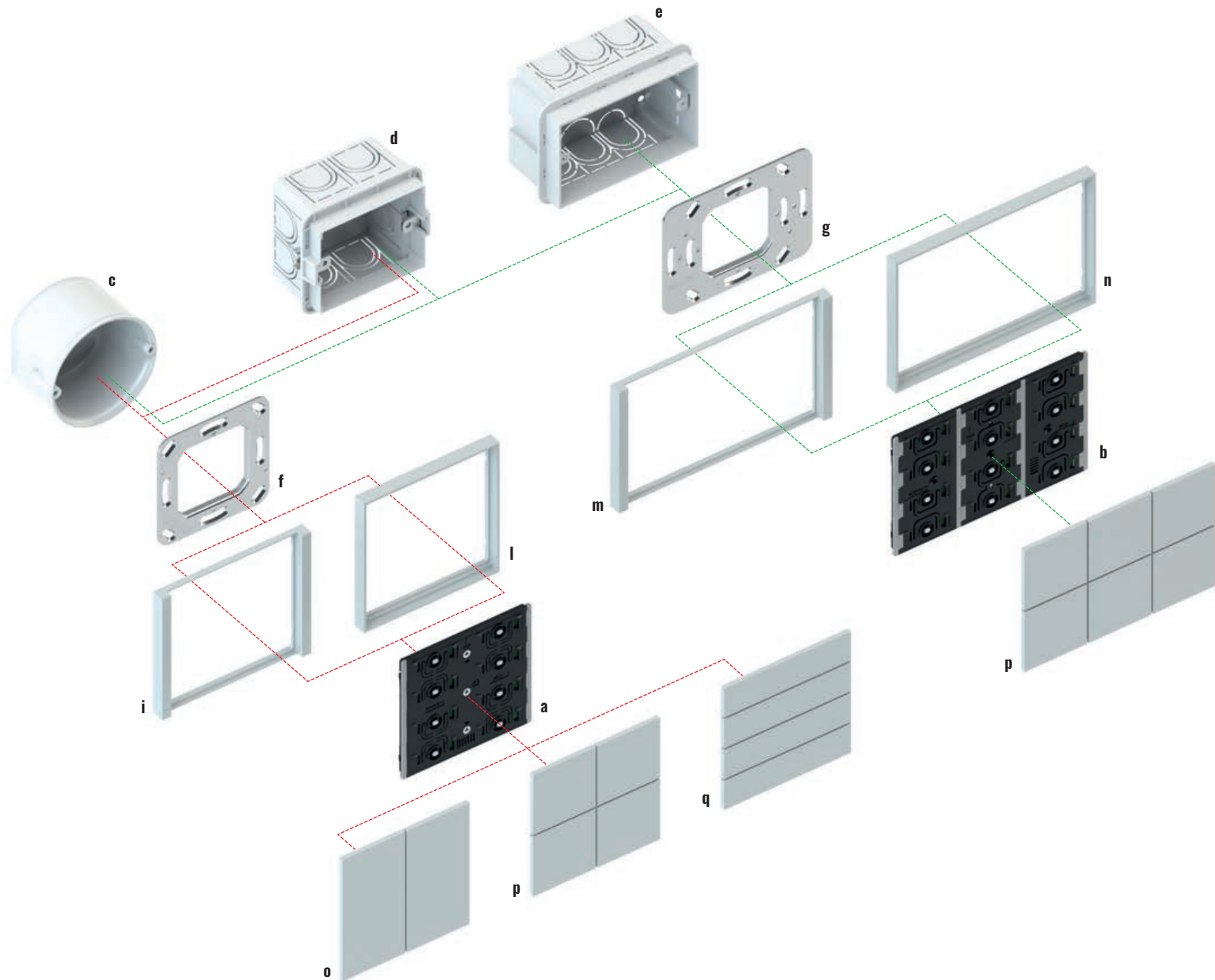

Four or six channels, square or rectangular keys, with or without frame, with or without LED, with or without temperature sensor and thermostat function. Choose the combination that best suits your needs of style and features.

The Ekinex® pushbuttons of FF series range and related accessories offer the possibility to realize several variations that will satisfy the most diverse needs. The base is represented by the 4-fold (EK-ED2-TP and EK-E32-TP) and 6-fold (EK-EH2-TP) pushbuttons; each one is fitted with a KNX communication module. The 4-fold pushbutton (a) is suitable for mounting into a flush mounting box, either round (c) or square (d), provided with fixing holes 60 mm apart, while the 6-fold version (b) is also ideal for mounting into a rectangular wall mounting box 3 seater (e) according to the Italian installation standard provided with fixing holes 83,5 mm apart. Each device is supplied with its relative metal support (f, g) which, in case of necessity, can also be ordered separately. A terminal block complete the supply.

The pushbuttons must be finished off with an operation surface (rockers) and a frame. The rockers are available in square (p) and rectangular (o, q) shapes, plastic material, aluminium or Fenix NTM®, in several colour and finishing variations. The rockers can be personalized with symbols and texts, so to make their function immediately understandable. Versions EK-ED2-TP and EK-EH2-TP have integrated LEDs which can be programmed freely: as an example, as a status feedback or as an orientation light at night time. Two colour combinations are available for the LEDs: blue / green or red / white. The same versions also offer a room thermostat function, thanks to the integrated temperature sensor. The frames, square (i, l) and rectangular (m, n), are available in two stylish alternatives (Form and Flank) and are available in plastic material or aluminium. The 'NF' version of the 4-fold pushbutton is mounted without frame and is provided with a side profile in white or black colour.



### Pushbuttons FF series

Description	Code	Page
a) 4-fold pushbutton and room thermostat FF series	EK-ED2-TP-... or EK-E32-TP-...	50-51
b) 6-fold pushbutton FF series	EK-EH2-TP-...	52
c) Round flush-mounting box	not delivered by Ekinex®	-
d) Square flush-mounting box	not delivered by Ekinex®	-
e) Rectangular flush-mounting box (3 modules)	not delivered by Ekinex®	-
f) Metal mounting support	EK-SMQ-71	153
g) Metal mounting support	EK-SMR-71	153

Description	Code	Page
i) Square frame Flank series	EK-FLQ-...	134
l) Square frame Form series	EK-FOQ-...	133
m) Rectangular frame Flank series	EK-FLR-...	134
n) Rectangular frame Form series	EK-FOR-...	133
o) Rectangular vertical rockers	EK-TRV-...	114
p) Square rockers	EK-TQQ-...	114
q) Rectangular horizontal rockers	EK-TRO-...	114



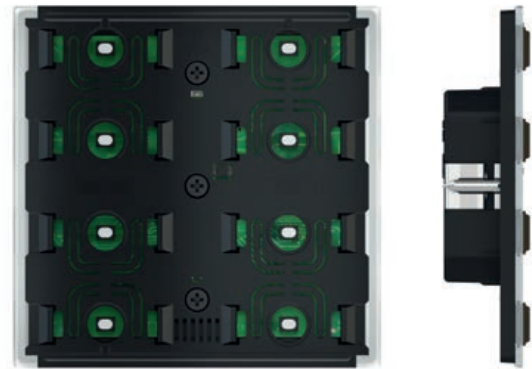

## 4-fold basic pushbutton - FF series

WALL-MOUNT DEVICES

### Description

The 4-fold pushbutton of Ekinex® FF series commands loads on/off switching, controls the dimming of lighting devices, controls motor drives for shutters or executes any other programmable command and control function. The device integrates a KNX bus communication module and is intended for mounting onto a wall mounting box: it is supplied by a SELV voltage directly from the KNX bus and does not require any auxiliary power supply.

### Main features

- 4-fold (possibility to configure up to 8 independent functions)
- Plastic casing
- Wall-mounting installation
- Connection to bus line with KNX terminal block
- Frontal programming pushbutton and LED
- IP20 protection degree (installed)
- Weight 80 g (with mounting support)

### Technical data

- 30 Vdc power supply through KNX bus
- Current consumption from bus < 15 mA

### Products included

Delivery includes a terminal block for connection to the bus, a metal support for installation onto round or square mounting box (fixing holes 60 mm apart) and two pairs of fixing screws.

### Accessories

The following accessories are available to be ordered separately:

- square or rectangular rockers
- square frame of Form or Flank series

### Dimensions [mm]

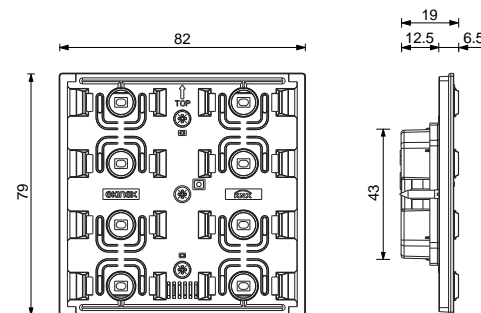

### Order information

Code	Mounting	Side profile
EK-E32-TP	with square frame of Form or Flank series	black
EK-E32-TP-NF	without frame ('NF series')	white
EK-E32-TP-NFW		

Also available in multiple pack of 8 pcs.



### Configuration and commissioning

By means of ETS5 software or later versions  
Application program: **APEKE32TP##.knxprod**  
(## = version, downloadable from [www.ekinex.com](http://www.ekinex.com))



### Documentation

For more information, see the **STEKE32TP\_EN.pdf**, technical sheet available for download from [www.ekinex.com](http://www.ekinex.com)



## 4-fold pushbutton and room thermostat - FF series

WALL-MOUNT DEVICES

### Description

The 4-fold pushbutton of Ekinex® FF series commands loads on/off switching, controls the dimming of lighting devices, controls motor drives for shutters or executes any other programmable command and control function. Thanks to the integrated temperature sensor, the pushbutton can work as a thermostat for a room or a zone. The LEDs can be chosen in the colour combinations blue / green or white / red. The device integrates a KNX bus communication module and is intended for mounting onto a wall mounting box: it is supplied by a SELV voltage directly from the KNX bus and does not require any auxiliary power supply.

### Main features

- 4-fold (possibility to configure up to 8 independent functions)
- 4 freely programmable LEDs for each channel
- 2 colour combination available for the LEDs (blue/green or red/white)
- Integrated temperature sensor
- Room thermostat function
- Plastic casing
- Wall-mounting installation on round or square wall box
- Connection to bus line with KNX terminal block
- Frontal programming pushbutton and LED
- IP20 protection degree (installed)
- Weight 80 g (with mounting support)

### Technical data

- 30 Vdc power supply through KNX bus
- Current consumption from bus < 15 mA

### Products included

Delivery includes a terminal block for connection to the bus, a metal support for installation onto round or square mounting box (fixing holes 60 mm apart) and two pairs of fixing screws.

### Accessories

The following accessories are available to be ordered separately:

- square or rectangular rockers
- square frame of Form or Flank series

### Dimensions [mm]

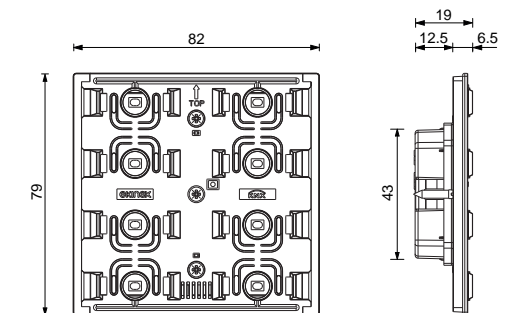

### Order information

Code	LED colours	Mounting	Side profile
EK-ED2-TP	blue / green	with square frame of Form or Flank series	black
EK-ED2-TP-RW	red / white		
EK-ED2-TP-BG-NF	blue / green	without frame ('NF series')	white
EK-ED2-TP-RW-NF	red / white		
EK-ED2-TP-BG-NFW	blue / green		
EK-ED2-TP-RW-NFW	red / white		

Also available in multiple pack of 8 pcs.



### Configuration and commissioning

By means of ETS5 software or later versions  
Application program: **APEKED2TP##.knxprod**  
(## = version, downloadable from [www.ekinex.com](http://www.ekinex.com))



### Documentation

For more information, see the **STEKED2TP\_EN.pdf**, technical sheet available for download from [www.ekinex.com](http://www.ekinex.com)







## 6-fold pushbutton - FF series

WALL-MOUNT DEVICES

### Description

The 6-fold pushbutton of Ekinex® FF series commands loads on/off switching, controls the dimming of lighting devices, controls motor drives for shutters or executes any other programmable command and control function. Thanks to the integrated temperature sensor, the pushbutton can send the room temperature value on the bus to other KNX devices. The LEDs can be chosen in the colour combinations blue / green or white / red. The device integrates a KNX bus communication module and is intended for mounting onto a wall mounting box; it is supplied by a SELV voltage directly from the KNX bus and does not require any auxiliary power supply.

### Main features

- 6-fold (possibility to configure up to 12 independent functions)
- 4 freely programmable LEDs for each channel
- 2 colour combination available for the LEDs (blue/green or red/white)
- Integrated temperature sensor
- Plastic casing
- Wall-mounting installation on round, square or rectangular wall box
- Connection to bus line with KNX terminal block
- Rear programming pushbutton and LED
- IP20 protection degree (installed)
- Weight 75 g (with mounting support)

### Technical data

- 30 Vdc power supply through KNX bus
- Current consumption from bus < 15 mA

### Products included

Delivery includes a terminal block for connection to the bus, a metal support for installation onto round or square mounting box (fixing holes 60 mm apart) or rectangular mounting box (fixing holes 83,5 mm apart) and two pairs of fixing screws.

### Accessories

- The following accessories are available to be ordered separately:
- square rockers
  - rectangular frame of Form or Flank series

### Dimensions [mm]

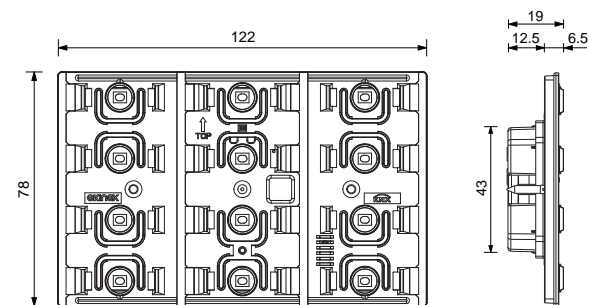

### Order information

Code	LED colours	Mounting
EK-EH2-TP	blue / green	with rectangular frame of Form or Flank series
EK-EH2-TP-RW	red / white	



### Configuration and commissioning

By means of ETS5 software or later versions  
Application program: **APEKEH2TP##.knxprod**  
(## = version, downloadable from [www.ekinex.com](http://www.ekinex.com))



### Documentation

For more information, see the **STEKEH2TP\_EN.pdf**, technical sheet available for download from [www.ekinex.com](http://www.ekinex.com)







## Room thermostats

WALL-MOUNT DEVICES - FF SERIES

### Aesthetics and functionality conjugated according to the Ekinex® style.

The room temperature controls of the FF series contain the characteristics of a product with a strong technological footprint combined with a focus on aesthetic component. Available in different models, integrated LEDs and two custom keys, the Ekinex® room controllers are with their high performance able to meet the most different needs.

#### Available colour solutions

	Form	Flank	'NF	Deep*	Surface*
Plastic	•	•	•	-	-
Metal	•	•	•	•	•
Fenix NTM®	•	-	•	•	•

For more information see page 161

\*) In the FF-Deep and Surface we suggest the use of the room thermostats of the FF-'NF' series



86 x 86 x 8 mm  
Form



94 x 86 x 8 mm  
Flank



80 x 80 x 8 mm  
'NF - Deep - Surface'



## Room thermostats - FF series

WALL-MOUNT DEVICES

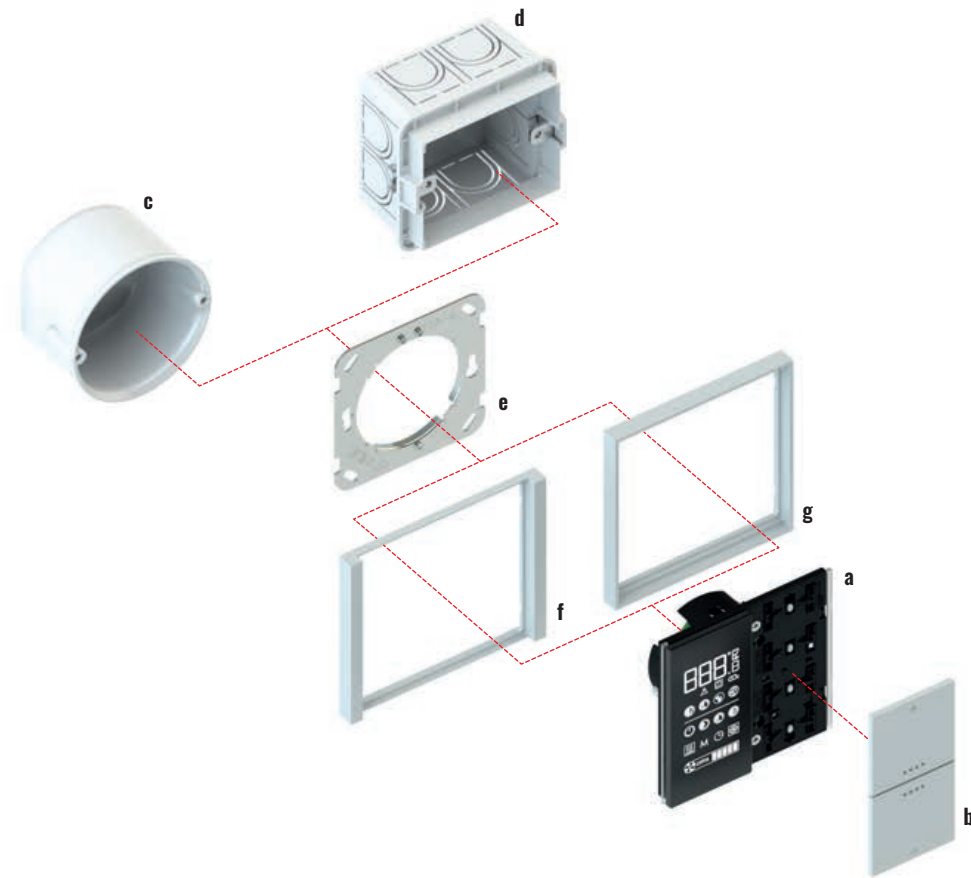

**Form, Flank, 'NF.**  
Three different variations for a room temperature control device with unique performance.

The Ekinex® thermostats of FF series range and related accessories offer the possibility to realize several variations that will satisfy the most diverse needs. The base is represented by the thermostats EK-EP2-TP and EK-EQ2-TP (with relative humidity sensor); each one integrates a KNX communication module. The device (a) is suitable for mounting into a flush mounting box, either round (c) or square (d), provided with fixing holes 60 mm apart. Each thermostat is delivered with its relative metal support (e) which, in case of necessity, can also be ordered separately. A terminal block completes the delivery.

The pushbuttons must be finished off with an operation surface (rockers) and a frame. The rockers are available in square shape, plastic material, aluminium or Fenix NTM® in several colour and finishing variations. A special set includes two customized rockers (b) with symbols for the thermostat functions. Each thermostat has integrated LEDs which can be programmed freely: as an example, as a status feedback or as an orientation light at night time. Two colour combinations are available for the LEDs: blue / green or red / white. The square frames are available in two stylish alternatives, Form (g) and Flank (f), and share the same choice of materials, colours and finishings as for rockers. The 'NF' version of the thermostat is mounted without frame and is provided with a side profile in white or black colour.

The thermostats simply get connected to the unique signal bus cable and do not require auxiliary power supply; the devices are powered at SELV (Safety Extra Low Voltage) voltage, thus offering a much higher safety level than traditional commands. The configuration and commissioning is carried out by means of the ETS® software. The related application programs can be downloaded from the [www.ekinex.com](http://www.ekinex.com) website.



### Room thermostats FF series

Description	Code	Page
a) Room thermostat FF series	EK-EP2-TP-... or EK-EQ2-TP-...	58-59
b) Set 2 rockers for thermostat FF series	EK-TQQ-...-EP2	116
c) Round flush-mounting box	not delivered by Ekinex®	-
d) Square flush-mounting box	not delivered by Ekinex®	-
e) Metal mounting support	EK-SMQ	153
f) Square frame of Flank series	EK-FLQ-...	134
g) Square frame of Form series	EK-FOQ-...	133





## Easy room thermostat - FF series

WALL-MOUNT DEVICES

### Description

The Ekinex® Easy room thermostat FF-series is a digital electronic thermostat with a user-friendly interface for the end user and system integrator. While using a single differentiated set point for heating and cooling with only one on/off operating mode, the unit allows the control of terminals with one or two stages (such as radiators, floor and ceiling radiant panels, etc.) and fan-coil units with 2 or 4 pipe hydraulic supply. The product is equipped with an LCD display with adjustable back-lighting, a sensor for room temperature measurement and two freely configurable inputs. The indicator LEDs can be chosen in blue/green or white/red colour combinations. The device has an integrated KNX bus communication module and is designed for installation in a flush-mounted wall box; it is powered by the KNX bus and requires no auxiliary power supply.

### Main features

- LCD display with adjustable backlighting
- 2 keys for controlling the thermostat functions
- 4 freely programmable LEDs for each button
- 2 colour combinations available for LEDs (blue/green or white/red)
- Integrated temperature sensor
- 2 freely programmable inputs
- Plastic housing
- Bus line connection via KNX terminal
- Programming button and LED on front panel
- Recessed wall mounting on round or square box
- IP20 degree of protection (installed)
- Weight 85 g (with mounting bracket)

### Technical data

- 30 Vdc power supply through KNX bus
- Current consumption from bus < 13 mA

### Products included

Delivery includes a terminal block for connection to the bus, a metal support for installation onto round or square mounting box (fixing holes 60 mm apart) and two pairs of fixing screws.

### Accessories

The following accessories are available to be ordered separately:

- set of two square rockers with symbols for room thermostat
- square frame of Form or Flank series

### Dimensions [mm]

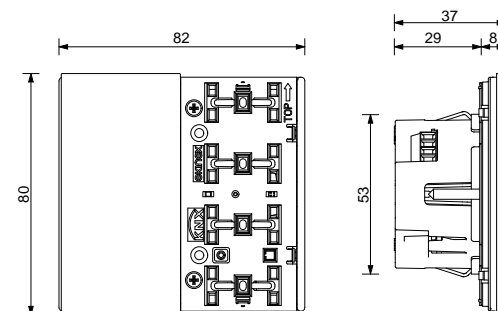

### Order information

Code	LED colours	Mounting	Side profile
EK-ER2-TP	blue / green	with square frame of Form or Flank series	-
EK-ER2-TP-RW	red / white	with square frame of Form or Flank series	-
EK-ER2-TP-BG-NF	blue / green	without frame ('NF series')	black
EK-ER2-TP-RW-NF	red / white	without frame ('NF series')	white
EK-ER2-TP-BG-NFW	blue / green	without frame ('NF series')	white
EK-ER2-TP-RW-NFW	red / white	without frame ('NF series')	white



### Configuration and commissioning

By means of ETS5 software or later versions  
Application program: **APEKER2TP##.knxprod**  
(## = version, download from [www.ekinex.com](http://www.ekinex.com))



### Documentation

For more information, see the **STEKER2TP\_EN.pdf**, technical sheet available for download from [www.ekinex.com](http://www.ekinex.com)



## Room thermostat - FF series

WALL-MOUNT DEVICES

### Description

The Ekinex® room temperature controller of FF series regulates independently the temperature of a room or a zone. In combination with one or more KNX actuators, the room temperature controller is able to control the heating and cooling emission of a series of terminal units for the thermal exchange (such as radiators, fan-coils, floor and ceiling radiant panels, etc.). The device is provided with a LCD-display with adjustable backlight, sensors for temperature and brightness measuring and two freely configurable inputs. The LEDs can be chosen in the colour combinations blue / green or white / red. The device integrates a KNX bus communication module and is intended for mounting onto a wall mounting box; it is powered by a SELV voltage directly from the KNX bus and does not require any auxiliary power supply.

### Main features

- LCD-display with adjustable backlight
- 2 rockers for controlling thermostat functions
- 4 freely programmable LEDs for each channel
- 2 colour combination available for the LEDs (blue/green or red/white)
- Integrated temperature sensor
- 2 freely configurable inputs
- Plastic casing
- Connection to bus line with KNX terminal block
- Frontal programming pushbutton and LED
- Wall-mounting installation on round or square wall box
- IP20 protection degree (installed)
- Weight 85 g (with mounting support)

### Technical data

- 30 Vdc power supply through KNX bus
- Current consumption from bus < 13 mA

### Products included

Delivery includes a terminal block for connection to the bus, a metal support for installation onto round or square mounting box (fixing holes 60 mm apart) and two pairs of fixing screws.

### Accessories

The following accessories are available to be ordered separately:

- set of two square rockers with symbols for room thermostat
- square frame of Form or Flank series

### Dimensions [mm]

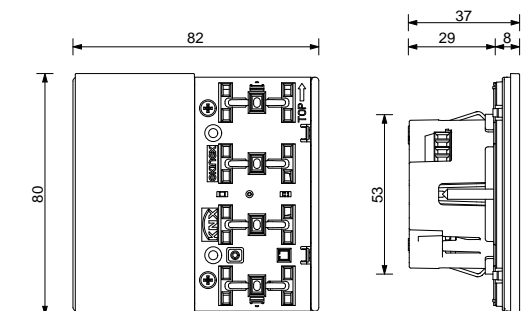

### Order information

Code	LED colours	Mounting	Side profile
EK-EP2-TP	blue / green	with square frame of Form or Flank series	-
EK-EP2-TP-RW	red / white	with square frame of Form or Flank series	-
EK-EP2-TP-BG-NF	blue / green	without frame ('NF series')	black
EK-EP2-TP-RW-NF	red / white	without frame ('NF series')	white
EK-EP2-TP-BG-NFW	blue / green	without frame ('NF series')	white
EK-EP2-TP-RW-NFW	red / white	without frame ('NF series')	white



### Configuration and commissioning

By means of ETS5 software or later versions  
Application program: **APEKEP2TP##.knxprod**  
(## = version, download from [www.ekinex.com](http://www.ekinex.com))



### Documentation

For more information, see the **STEKEP2TP\_EN.pdf**, technical sheet available for download from [www.ekinex.com](http://www.ekinex.com)







## Room thermostat - FF series with relative humidity sensor

WALL-MOUNT DEVICES

### Description

The Ekinex® room temperature controller of FF series regulates independently the temperature of a room or a zone. In combination with one or more KNX actuators, the room temperature controller is able to control the heating and cooling emission of a series of terminal units for the thermal exchange (such as radiators, fan-coils, floor and ceiling radiant panels, etc.). The device is provided with a LCD-display with adjustable backlight, sensors for temperature, relative humidity and brightness measuring and two freely configurable inputs. The LEDs can be chosen in the colour combinations blue / green or white / red. The device integrates a KNX bus communication module and is intended for mounting onto a wall mounting box; it is powered by a SELV voltage directly from the KNX bus and does not require any auxiliary power supply.

### Main features

- LCD-display with adjustable backlight
- 2 rockers for controlling thermostat functions
- 4 freely programmable LEDs for each channel
- 2 colour combination available for the LEDs (blue/green or red/white)
- Integrated temperature and relative humidity sensor
- 2 freely configurable inputs
- Plastic casing
- Connection to bus line with KNX terminal block
- Frontal programming pushbutton and LED
- Wall-mounting installation on round or square wall box
- IP20 protection degree (installed)
- Weight 85 g (with mounting support)

### Technical data

- 30 Vdc power supply through KNX bus
- Current consumption from bus < 13 mA

### Products included

Delivery includes a terminal block for connection to the bus, a metal support for installation onto round or square mounting box (fixing holes 60 mm apart) and two pairs of fixing screws.

### Accessories

The following accessories are available to be ordered separately:

- set of two square rockers with symbols for room thermostat
- square frame of Form or Flank series

### Dimensions [mm]

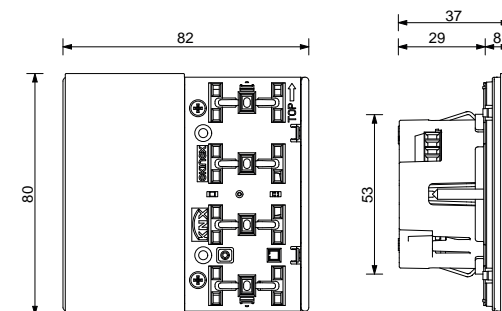

### Order information

Code	LED colours	Mounting	Side profile
EK-EQ2-TP	blue / green	with square frame of Form or Flank series	-
EK-EQ2-TP-RW	red / white	with square frame of Form or Flank series	-
EK-EQ2-TP-BG-NF	blue / green	without frame (NF series)	black
EK-EQ2-TP-RW-NF	red / white	without frame (NF series)	black
EK-EQ2-TP-BG-NFW	blue / green	without frame (NF series)	white
EK-EQ2-TP-RW-NFW	red / white	without frame (NF series)	white



### Configuration and commissioning

By means of ETS5 software or later versions  
Application program: **APEKEQ2TP##.knxprod**  
(## = version, download from [www.ekinex.com](http://www.ekinex.com))



### Documentation

For more information, see the **STEKEQ2TP\_EN.pdf**, technical sheet available for download from [www.ekinex.com](http://www.ekinex.com)







## Touch&See

WALL-MOUNT DEVICES - FF SERIES

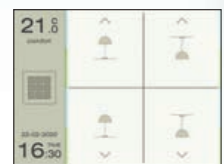

Controls

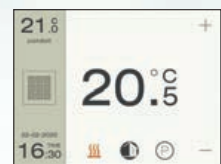

Thermostat

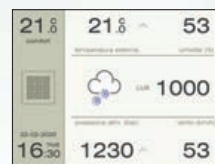

Meteo



Date

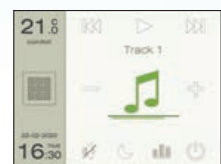

Music



Scenes

**Technology in a touch.** When you want to touch the technology, see with your eyes your settings, know the weather or create the comfort you would like, trust Touch&See. The high resolution touch-display and the versatile and intuitive interface are thought to provide highest user comfort and uncompromising aesthetics. The transition from one function to the next one is via side-scrolling pages, from those you can access several sub-menus. You can also set the display brightness according to your own needs or it can be automatically adjusted according to the brightness.

### Available colour solutions

	Form	Flank	'NF**	Deep*	Surface*
Plastic	•	•	-	-	-
Metal	•	•	-	-	-
Fenix NTM®	•	-	-	-	-

For more information see page 161

\*) In the FF-Deep and Surface series you can use the Touch&See display of the FF-'NF series

\*\*) 'NF available only in EC2 version



86 x 86 x 8 mm  
Form



94 x 86 x 8 mm  
Flank



80 x 80 x 8 mm  
'NF - Deep - Surface

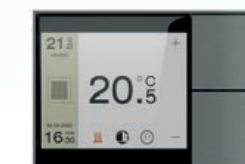

126 x 86 x 8 mm  
Form



134 x 86 x 8 mm  
Flank



## Touch&See - FF series

WALL-MOUNT DEVICES

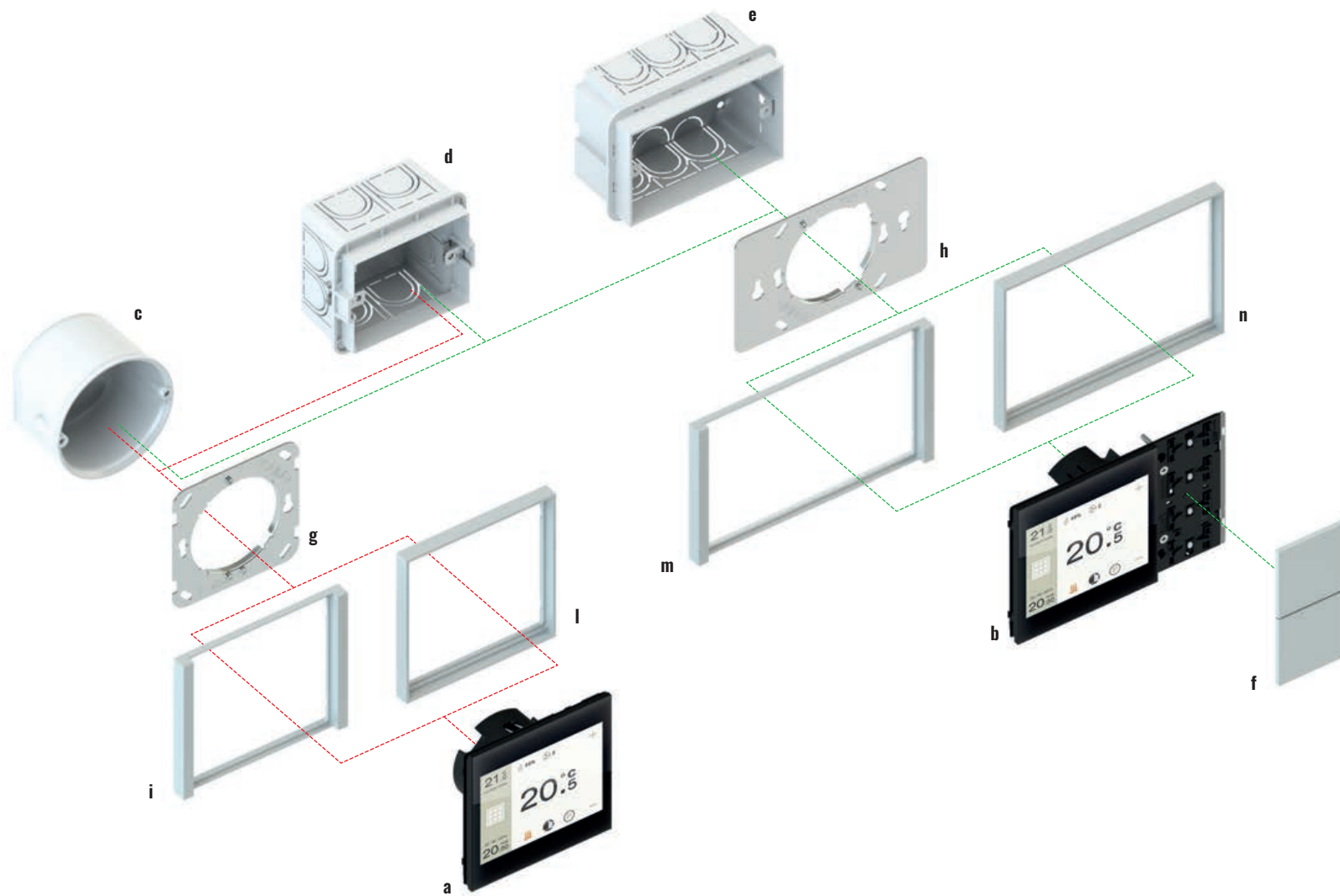

Control and display unit with two-channel pushbutton. You will be amazed at all you can do.

The Ekinex® Touch&See display and control units allow to perform a great number of switching, control and display bus functions, utilizing the easiest and most compact devices, with their 3.5" touch-screen and their graphic pages having a clear meaning and immediate understanding.

The base is represented by the control and display unit (EK-EC2-TP-...) and the control and display unit with integrated 2-fold pushbutton (EK-EF2-TP-...); each one integrates a KNX communication module. The control and display unit (a) is suitable for round (c) or square (d) wall mounting boxes with fixing holes 60 mm apart; the unit with the integrated 2-fold pushbutton (b) is also suitable for rectangular wall mounting boxes (e) provided with fixing holes 85 mm apart (3 seater according to the Italian installation standard).

Each Touch&See unit is delivered with a metal mounting support (g, h) which, in case of necessity, can also be obtained separately; the terminal blocks complete the supply. The Touch&See unit needs to be finished with a frame (i, l, m, n); in the case of units with integrated 2-fold pushbuttons, it will also be necessary to provide it with two square rockers (f), available in plastic or aluminium and in several colours and finishings. The frames, either square (i, l) or rectangular (m, n), are available in two alternative styles (Form and Flank) and share the same choice of materials, colours and finishing. The rockers can be personalized with symbols and text, in order to make their function immediately understandable. Each channel of the 2-fold pushbutton has integrated LEDs which can be programmed freely: as an example, as a status feedback or as an orientation light at night time. Two colour combinations are available for the LEDs: blue / green or red / white. The 'NF' version of the Touch&See EK-EC2-TP-... is mounted without frame and is provided with a side profile in white or black colour.

The Touch&See units have to be connected to the signal bus cable and to an auxiliary power supply; the devices are powered at SELV (Safety Extra Low Voltage) voltage, thus offering a much higher safety level than traditional commands. The configuration and commissioning is carried out by means of the ETS® software. The related application programs can be downloaded from the [www.ekinex.com](http://www.ekinex.com) website.



### Touch&See FF series

Description	Code	Page
a) Touch&See display	EK-EC2-TP-...	66
b) Touch&See display with 2-fold pushbutton	EK-EF2-TP-...	67
c) Round flush-mounting box	not delivered by Ekinex®	-
d) Square flush-mounting box	not delivered by Ekinex®	-
e) Rectangular flush-mounting box (3 modules)	not delivered by Ekinex®	-
f) Square rockers	EK-TQQ-...	115

Description	Code	Page
g) Metal mounting support	EK-SMQ	153
h) Metal mounting support	EK-SMR	153
i) Square frame Flank series	EK-FLQ-...	134
l) Square frame Form series	EK-FOQ-...	133
m) Rectangular frame Flank series	EK-FLR-...	134
n) Rectangular frame Form series	EK-FOR-...	133



## Touch&See display

WALL-MOUNT DEVICES

### Description

Ekinex® Touch&See is a KNX device for the switching, control and display of bus functions. By means of its touch-screen and its graphical user interface, it is possible to control KNX actuators in an easy and intuitive way, to display the information coming from the KNX actuators and sensors and to perform as a room thermostat for up to 8 independent zones, receiving the measured room temperature values from the bus. The device integrates a KNX bus communication module and is designed for wall mounting boxes: it is powered by a SELV voltage directly from the KNX bus and requires an auxiliary 30 Vdc power supply.

### Main features

- 3,5" TFT back-lit touch display, 320 x 240 pixel resolution, 65,536 colours
- Seven main graphic pages
- Plastic casing
- Connection to bus line with KNX terminal block
- Connection to auxiliary power supply with yellow / white terminal block
- Programming pushbutton and LED on the rear
- Wall-mounting installation on round or square wall box
- IP20 protection degree (installed)
- Weight 110 g (with mounting support)

### Technical data

- SELV power supply from KNX bus (communication)
- 30 Vdc auxiliary power supply (screen)

### Products included

Delivery includes a terminal block for connection to the bus, a terminal block for connection to the auxiliary power supply, a metal support for installation onto round or square mounting box (fixing holes 60 mm apart) and two pairs of fixing screws.

### Accessories

The following accessories are available to be ordered separately:

- square frame of Form or Flank series

### Dimensions [mm]

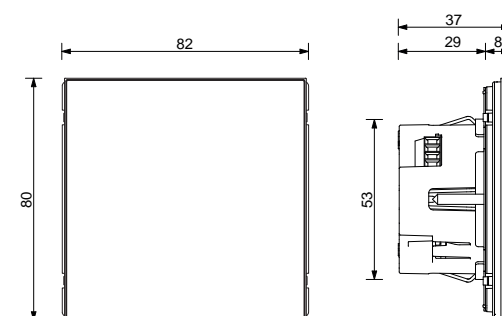

### Configuration and commissioning

By means of ETS5 software or later versions  
Application program: **APEKEC2TP##.knxprod**  
(## = version, download from [www.ekinex.com](http://www.ekinex.com))



### Documentation

For more information, see the **STEKEC2TP\_EN.pdf**, technical sheet available for download from [www.ekinex.com](http://www.ekinex.com)



## Touch&See display with 2-fold pushbutton

WALL-MOUNT DEVICES

### Description

Ekinex® Touch&See with 2-fold pushbutton is a KNX device for the switching, control and display of bus functions. By means of its touch-screen and the graphical user interface, it is possible to control KNX actuators in an easy and intuitive way, to display information coming from KNX actuators and sensors and to perform as a room thermostat for a maximum of 8 independent zones. One temperature value can be measured from the integrated sensor, while the other values can be received from the bus. The integrated 2-fold pushbutton allows the on/off command of loads, the dimming of lighting devices, the control of motor drives for shutters or the execution of any other programmable command and control function. The LEDs can be chosen in the colour combinations blue / green or white / red. The device integrates a KNX bus communication module and is designed for mounting onto a wall-mounting box: it is powered by SELV voltage directly from the KNX bus and requires an auxiliary 30 Vdc power supply.

### Main features

- 3,5" TFT back-lit touch display, 320 x 240 pixel resolution, 65,536 colours
- Seven main graphic pages
- Integrated temperature sensor
- 2-fold pushbutton (possibility to configure up to 4 independent functions)
- 4 freely programmable LEDs for each channel
- 2 colour combination available for the LEDs (blue/green or red/white)
- Plastic casing
- Connection to bus line with KNX terminal block
- Connection to auxiliary power supply with yellow / white terminal block
- Programming pushbutton and LED on the rear
- Wall-mounting installation on round, square or rectangular wall box
- IP20 protection degree (installed)
- Weight 130 g (with mounting support)

### Technical data

- SELV power supply from KNX bus (communication)
- 30 Vdc auxiliary power supply (screen)

### Products included

Delivery includes a terminal block for connection to the bus, a terminal block for connection to the auxiliary power supply, a metal support for installation onto round or square mounting box (fixing holes 60 mm apart) or rectangular mounting box (fixing holes 83,5 mm apart) and two pairs of fixing screws.

### Accessories

The following accessories are available to be ordered separately:

- square rockers
- rectangular frame of Form or Flank series

### Dimensions [mm]

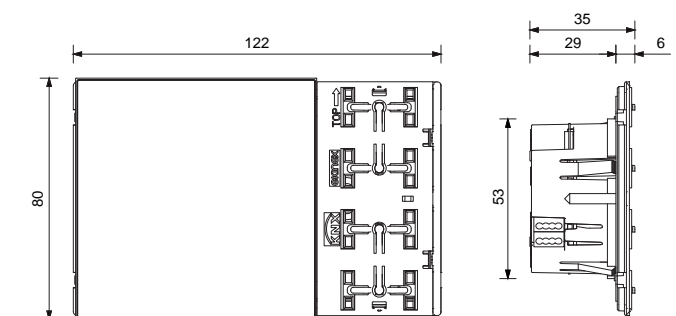

### Configuration and commissioning

By means of ETS5 software or later versions  
Application program: **APEKEF2TP##.knxprod**  
(## = version, download from [www.ekinex.com](http://www.ekinex.com))



### Documentation

For more information, see the **STEKEF2TP\_EN.pdf**, technical sheet available for download from [www.ekinex.com](http://www.ekinex.com)





## Sensors

WALL AND CEILING-MOUNTING DEVICES

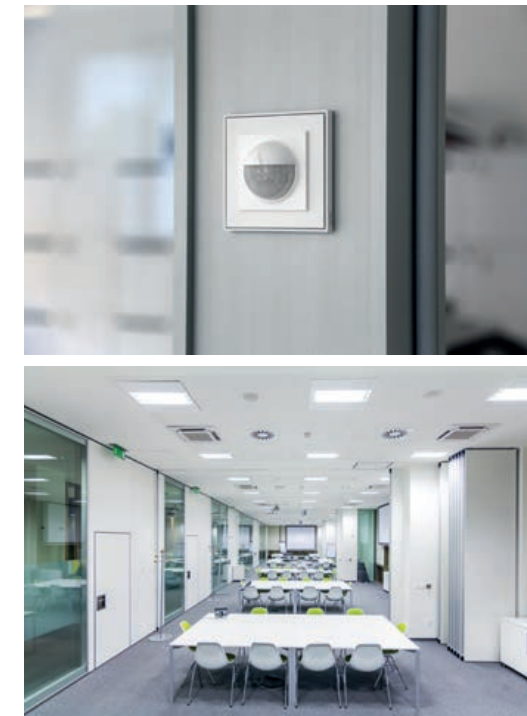
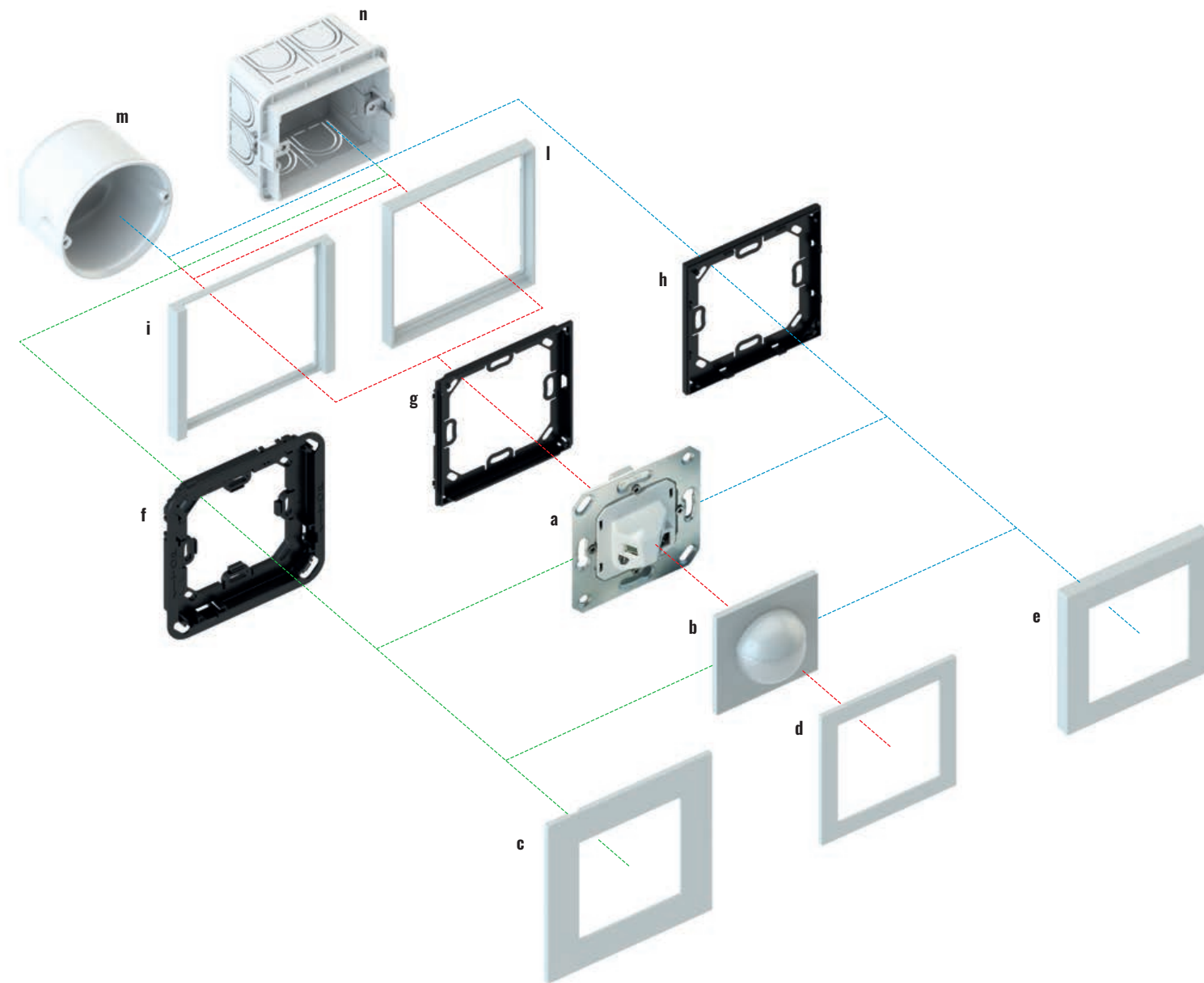

**Movement and presence sensors complete with frames Form, Flank or in the NF, Deep and Surface versions for aesthetics coordinated to the Ekinex® pushbuttons.**

The Ekinex® movement sensor allows to control automatically bus functions, such as lighting or room heating and cooling. The base is represented by the device (EK-SM2-TP) which integrates a KNX communication module. The device (a), delivered with the corresponding metal mounting support and a terminal block for the bus connection, is suitable for round (m) or square (n) wall mounting boxes with fixing holes 60 mm apart.

The movement sensor needs to be finished with a square plate with 60 x 60 mm window and a square frame of Flank (i) or Form (j) series, available in plastic or aluminium and in several colours and finishings. The device may be also installed with frame by separately ordering a square 'NF, Deep or Surface adapter provided with a side profile in white or black colour ('NF only).

The movement sensor has to be connected to the signal bus cable: the device is powered at SELV (Safety Extra Low Voltage) voltage, thus offering a much higher safety level than traditional sensors. The configuration and commissioning is carried out by means of the ETS® software. The related application programs can be downloaded from the [www.ekinex.com](http://www.ekinex.com) website.

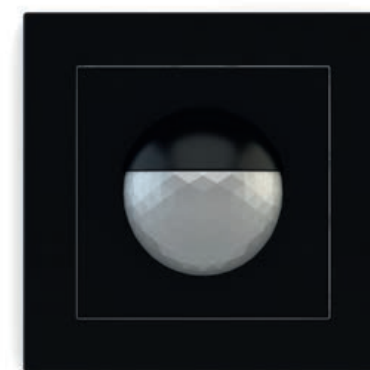

### Movement sensor

Description	Code	Page
a) Movement sensor with metallic support	EK-SM2-TP-GA_	70
b) Cover with lens		70
c) Square plate Surface series*	EK-SQS-...	143
d) Square plate*	EK-PQS-...	136
e) Square plate Deep series*	EK-DQS-...	139
f) Adapter for Surface square plate	EK-TAS-Q-...-NF	143

Description	Code	Page
g) Adapter for square plate	EK-TAQ	136
h) Adapter for 'NF and Deep square plate	EK-TAQ-...-NF	136-139
i) Square frame of Flank series	EK-FLQ-...	134
j) Square frame of Form series	EK-FOQ-...	133
m) Round flush-mounting box	not delivered by Ekinex®	-
n) Square flush-mounting box	not delivered by Ekinex®	-

\*) 60 x 60 mm window



## Movement sensor

WALL-MOUNT DEVICES

### Description

The Ekinex® EK-SM2-TP movement sensor detects movement and presence of people in a semi-circular area. It is ideally used in corridors, transit areas, toilets, staircases, elevators and, in general, all areas having occasional transit. The device has one channel for lighting, and one channel for the control of HVAC devices. Movement and presence detection are operated by three PIR sensors (passive infra-red); one further sensor measures room luminosity. The device can work in semi-automatic or automatic mode. The device integrates a KNX bus communication module, is suitable for flush-mounting boxes and is powered by a SELV voltage by means of the KNX bus.

### Main features

- 180° detection range (semi-circular)
- Max distance 10 m (mounted at 3 m height)
- Mounting height from 1 to 3 m
- 3 passive infra-red (PIR) sensors
- Adjustable sensitivity (10 levels)
- Master or slave configuration
- Connection to bus line with KNX terminal block
- Frontal programming pushbutton and LED
- Wall-mounting installation on round or square wall box
- Metal support with screws for mounting on round or square mounting box (holes 60 mm apart)
- IP20 protection degree (installed)
- Weight 40 g

### Technical data

- SELV voltage from KNX bus
- Power absorption 0,4 W

### Products included

Delivery includes a terminal block for connection to the bus, a metal support for installation onto round or square mounting box (fixing holes 60 mm apart) and two fixing screws.

### Accessories

The following accessories are available to be ordered separately:

- square frame in Form or Flank series
- square plate with window 60 x 60 mm



EK-SM2-TP-GAA

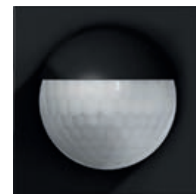

EK-SM2-TP-GAE

### Dimensions [mm]

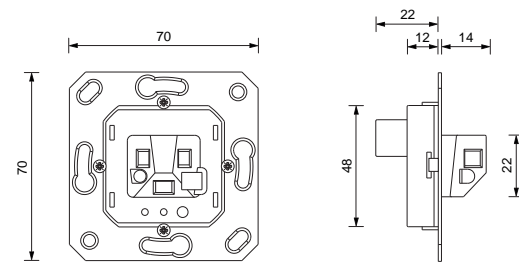

### Configuration and commissioning

By means of ETS5 software or later versions  
Application program: **APEKSM2TP##.vd4**  
(## = version, download from [www.ekinex.com](http://www.ekinex.com))



### Documentation

For more information, see the **STEKSM2TP\_EN.pdf** technical sheet available for download from [www.ekinex.com](http://www.ekinex.com)



### Order information

Code	Lens colour	Package
EK-SM2-TP-GAA	Bianco	1 pcs.
EK-SM2-TP-GAE	Nero	1 pcs.



## Ceiling mounted presence sensor

WALL-MOUNT DEVICES

### Description

The Ekinex® presence sensor EK-DF2-TP is a ceiling flush mount Passive Infrared (PIR) motion detector, for the detection of movement and presence of people in indoor spaces with a coverage area of 360°. The detection area can be extended using other sensors configured as slave devices. An integrated light sensor, combined with the motion detector, can manage light switching depending on brightness level as well as presence. The device has two distinct output channels for lighting, with independent parameters; the operation can be automatic or semi automatic. The device is also capable of maintaining a constant brightness level in the room by controlling a dimmable light source. All of the above parameters can be set by the user either through ETS or by means of a dedicated IR remote during installation. The device has two additional HVAC channels, which act in a similar way as the Light Control channels but without the standby time and light level dependence. An additional alarm channel can switch the load on or off depending on the number of trigger events (movements) detected in a time frame of configurable duration

### Main features

- Semi-automatic or fully automatic operation
- Two independent Light control channels
- Two independent HVAC control channels
- One alarm channel
- An additional device can be used as slave for any of the channels
- Detection span of 360°, sectors can be masked through optical shields
- Adjustable Sensitivity, with "Walk test" to verify detection range
- Parameters can be set from ETS or through an IR remote

### Technical data

- Rated voltage: 24 Vdc (21 - 30 Vdc) supplied by KNX bus
- Current consumption (on KNX bus): max 10 mA (operation) / 5 mA (Standby)
- Detection range: 360° circular (maskable), **up to 9 m diameter at 2.5 m mounting height**
- Light measurement range: 10..2000 Lux
- Housing, lens and frame in plastic material
- Safety standards: IEC 61000-6-1 / IEC 61000-6-3 / EN55014 / EN 50491

### Order information

Code	Package
EK-DF2-TP	1 pcs.

### Environmental conditions

- Operating temperature: - 20 ... + 40°C
- Relative humidity: 95% not condensing
- Environmental protection: IP20

### Switching, display and detection elements

The device is equipped with:

- on the rear side, a programming pushbutton
- visible through the plastic lens, a blue programming LED, a red signalling LED, a PIR sensor, a brightness sensor and an IR receiver

### Accessories

The following accessories are available to be ordered separately:

- IR Remote Controller - EK-QR6-IR and support for protruding mounting - EK-QS3



### Dimensions [mm]

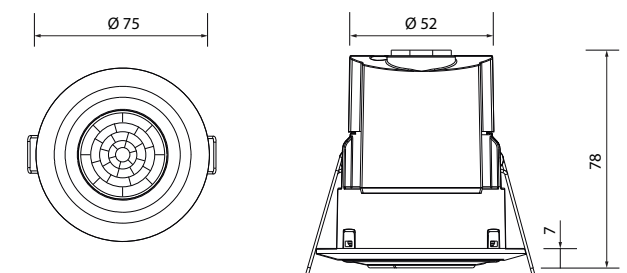

### Configuration and commissioning

By means of ETS5 software or later versions  
Application program: **APEKDF2TP##.knxprod**  
(## = version, download from [www.ekinex.com](http://www.ekinex.com))



### Documentation

For more information, see the **STEKDF2TP\_EN.pdf** technical sheet available for download from [www.ekinex.com](http://www.ekinex.com)



EK-DF2-TP



EK-QR6-IR





## Ceiling mounted presence sensor

WALL-MOUNT DEVICES

### Description

The Ekinex® presence sensor EK-DG2-TP is a ceiling flush mount Passive Infrared (PIR) motion detector, for the detection of movement and presence of people in indoor spaces with a coverage area of 360°. The detection area can be extended using other sensors configured as slave devices. An integrated light sensor, combined with the motion detector, can manage light switching depending on brightness level as well as presence. The device has two distinct output channels for lighting, with independent parameters; the operation can be automatic or semi automatic. The device is also capable of maintaining a constant brightness level in the room by controlling a dimmable light source. All of the above parameters can be set by the user either through ETS or by means of a dedicated IR remote during installation. The device has two additional HVAC channels, which act in a similar way as the Light Control channels but without the standby time and light level dependence. An additional alarm channel can switch the load on or off depending on the number of trigger events (movements) detected in a time frame of configurable duration.

### Main features

- Semi-automatic or fully automatic operation
- Two independent Light control channels
- Two independent HVAC control channels
- One alarm channel
- An additional device can be used as slave for any of the channels
- Detection span of 360°, sectors can be masked through optical shields
- Adjustable Sensitivity, with "Walk test" to verify detection range
- Parameters can be set from ETS or through an IR remote

### Technical data

- Rated voltage: 24 Vdc (21 - 30 Vdc) supplied by KNX bus
- Current consumption (on KNX bus): max 10 mA (operation) / 5 mA (Standby)
- Detection range: 360° circular (maskable), **up to 12 m diameter at 2.5 m mounting height**
- Light measurement range: 10..2000 Lux
- Housing, lens and frame in plastic material
- Safety standards: IEC 61000-6-1 / IEC 61000-6-3 / EN55014 / EN 50491

### Environmental conditions

- Operating temperature: - 20 ... + 40°C
- Relative humidity: 95% not condensing
- Environmental protection: IP20

### Switching, display and detection elements

The device is equipped with:

- on the rear side, a programming pushbutton
- visible through the plastic lens, a blue programming LED, a red signalling LED, a PIR sensor, a brightness sensor and an IR receiver

### Accessories

The following accessories are available to be ordered separately:

- IR Remote Controller - EK-QR6-IR and support for protruding mounting - EK-QS3



### Dimensions [mm]

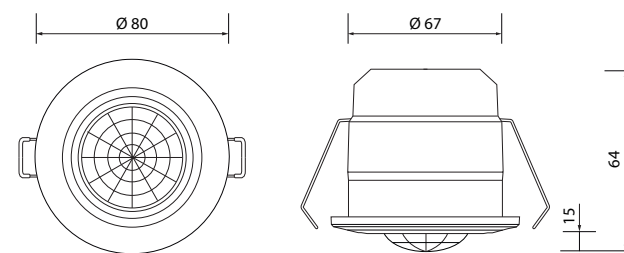

### Configuration and commissioning

By means of ETS5 software or later versions  
Application program: **APEKD62TP##.knxprod**  
(## = version, download from [www.ekinex.com](http://www.ekinex.com))



### Documentation

For more information, see the **STEKD62TP\_EN.pdf** technical sheet available for download from [www.ekinex.com](http://www.ekinex.com)



EK-DG2-TP



EK-QR6-IR



## Presence sensor for outdoor mounting

WALL-MOUNT DEVICES

### Description

The Ekinex® EK-DH4-TP presence sensor is an infrared motion detector passive (PIR) for outdoor ceiling or wall mounting, for motion and presence detection of people in outdoor spaces with a 360° coverage area. The detection area can be extended using other sensors configured as slave devices. One integrated light sensor, combined with the motion detector, can manage the ignition of light according to brightness level and presence. The device has two channels of separate output for lighting, with independent parameters; the operation can be automatic or semi-automatic. All the above listed parameters can be set by the user via ETS or via a dedicated IR remote control during installation. The device has two additional HVAC channels, which act similarly to brightness control channels, but without the standby time function and light level dependency. One additional alarm channel can activate or deactivate the load depending on the number of trigger events (movements) detected in a configurable time interval.

### Main features

- Semi-automatic or fully automatic operation
- Two independent light control channels
- Two independent HVAC control channels
- An alarm channel
- An additional device can be used as a slave for any of the channels
- Detection range of 360° (180° on the wall), sectors can be masked through optic screens
- Adjustable sensitivity, with "Walk test" to verify the detection radius
- Parameters can be set by ETS or via an IR remote control.

### Technical data

- Rated voltage: 24 VDC (21-30 VDC) supplied by KNX bus
- Current consumption (on KNX bus): max. 10 mA (operation) / 5 mA (standby)
- Sensing range: 360° circular (masking), **up to 32 m diameter at 2.5 m mounting height**
- Light measuring range: 10..2000 Lux
- Housing, lens and frame in plastic material
- Safety standards: IEC 61000-6-1 / IEC 61000-6-3 / EN 55014 / EN 50491

### Environmental conditions

- Operating temperature: - 20 ... + 40°C
- Relative humidity: 95% not condensing
- Environmental protection: IP20

### Switching, display and detection elements

The device is equipped with:

- on the rear side, a programming pushbutton
- visible through the plastic lens, a blue programming LED, a red signalling LED, a PIR sensor, a brightness sensor and an IR receiver

### Accessories

The following accessories are available to be ordered separately:

- IR Remote Controller - EK-QR6-IR



### Dimensions [mm]

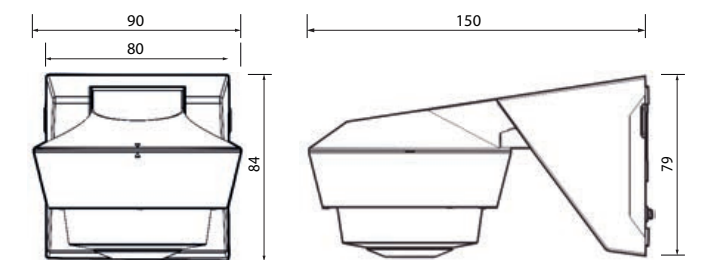

### Configuration and commissioning

By means of ETS5 software or later versions  
Application program: **APEKD4TP##.knxprod**  
(## = version, download from [www.ekinex.com](http://www.ekinex.com))



### Documentation

For more information, see the **STEKD4TP\_EN.pdf** technical sheet available for download from [www.ekinex.com](http://www.ekinex.com)



EK-DH4-TP



EK-QR6-IR

# 71

## WALL-MOUNT DEVICES

### SERIES

Form	74
Flank	76
*NF	78
Deep	80
Surface	82





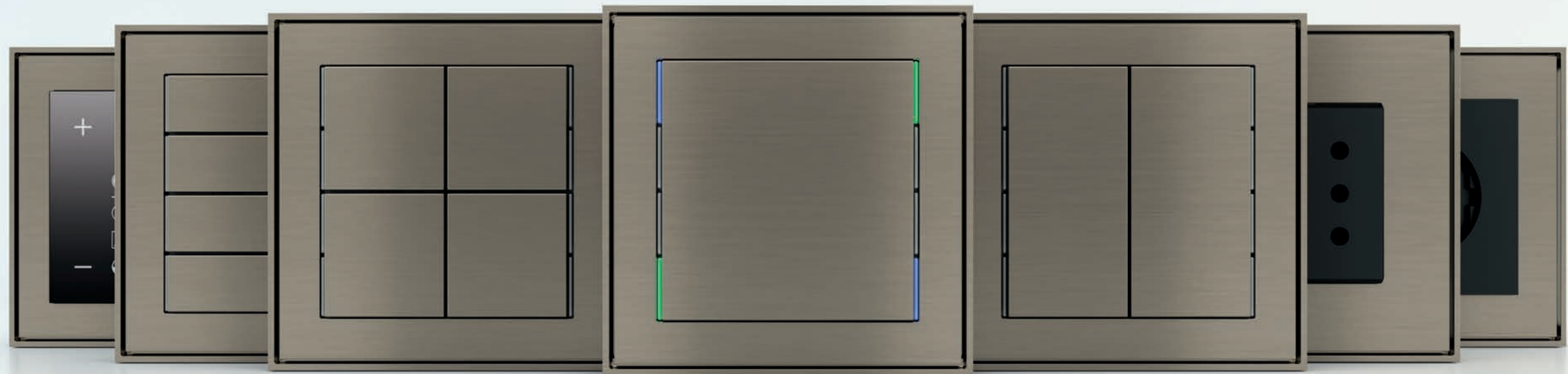

## 71 - Form

WALL-MOUNT DEVICES - 71 SERIES

**Elegant and refined. The compactness that adapts to your style.** With an ultra-thin frame, the Form line of the 71 series has integrated plastic or metal pushbuttons, thermostats and plates for sockets and LEDs with adjustable light intensity in blue/green or white/red colour combinations. The different finishes can be freely combined with each other.

**Available colour solutions**

	Form	Flank	'NF	Deep	Surface
<b>Plastic</b>	•	•	•	-	-
<b>Metal</b>	•	•	•	•	•
<b>Fenix NTM®</b>	•	-	•	•	•

For more information see page 161

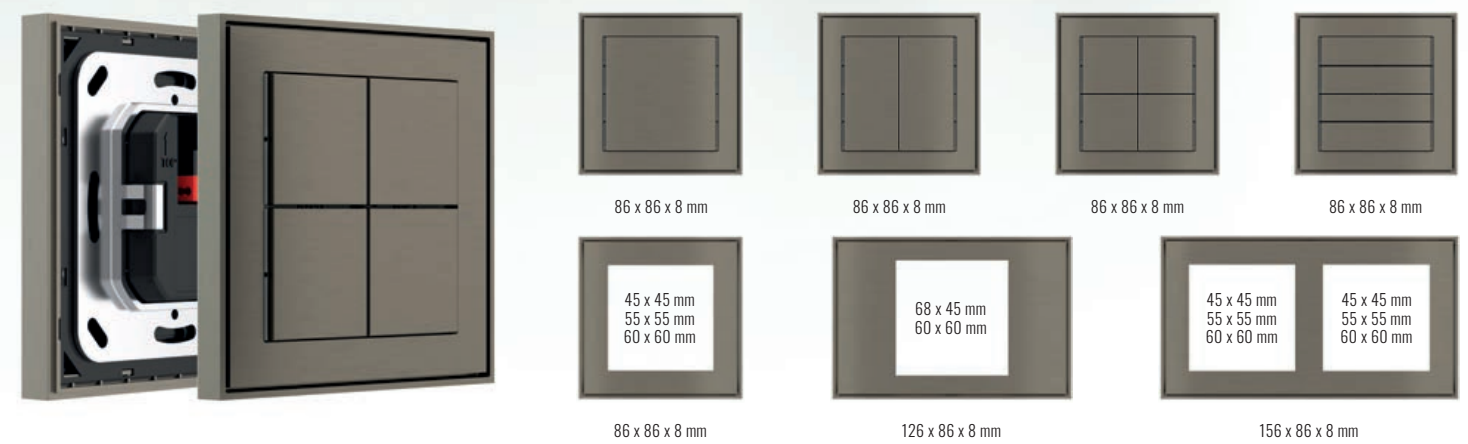



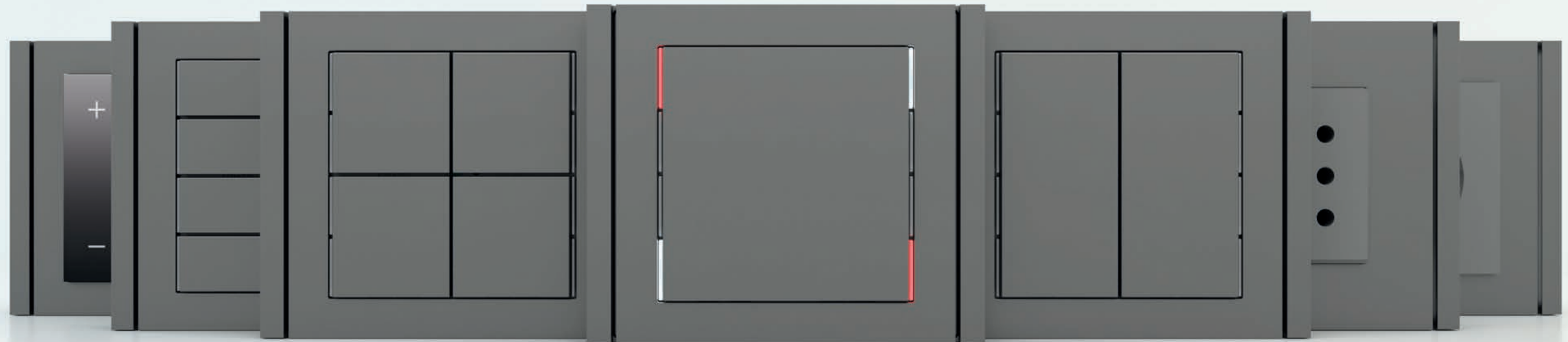

## 71 - Flank

WALL-MOUNT DEVICES - 71 SERIES

**Harmony and essentiality.** The rigorous simplicity of detail. The Flank line of the 71 series has pushbuttons, thermostats and plates for sockets with simple shapes that can be distinguished by the characteristic side edges. The plastic or metal finishes can be combined according to your taste and needs.

### Available colour solutions

	Form	Flank	'NF	Deep	Surface
<b>Plastic</b>	•	•	•	-	-
<b>Metal</b>	•	•	•	•	•
<b>Fenix NTM®</b>	•	-	•	•	•

For more information see page 161

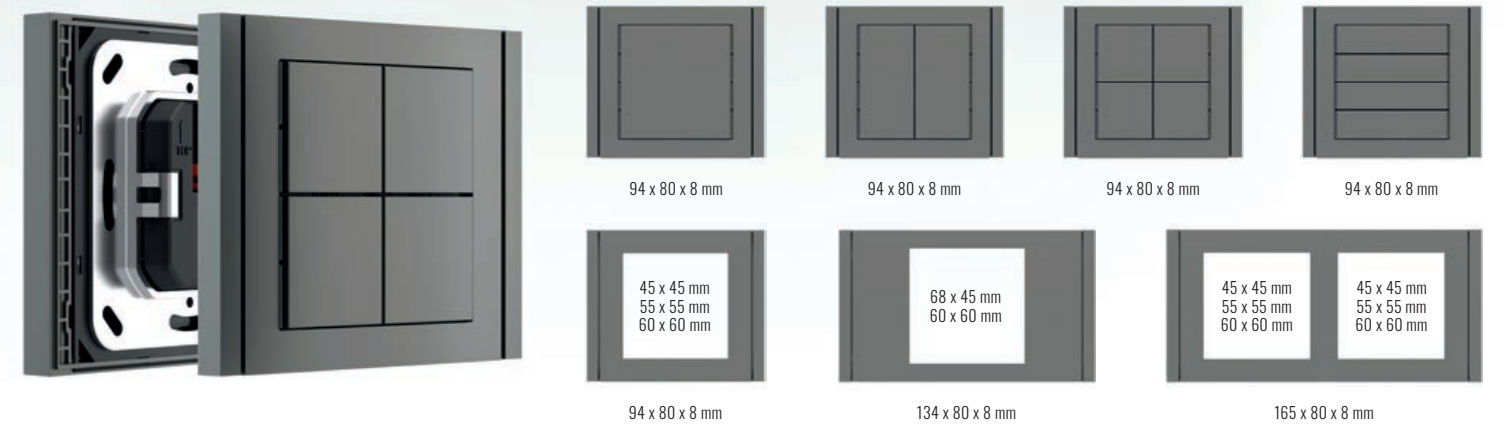

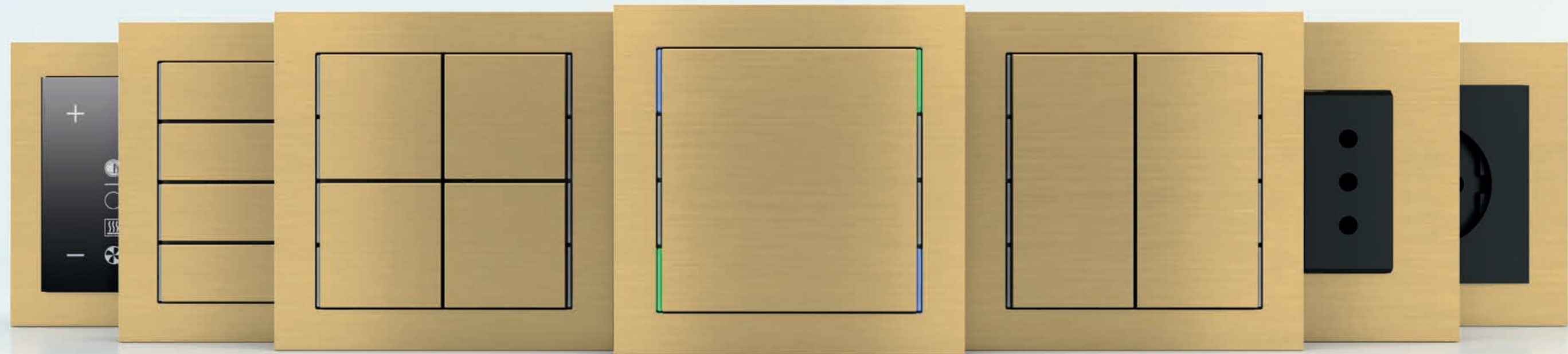

**71 - 'NF**  
WALL-MOUNT DEVICES - 71 SERIES

**Simple and rational.** Frameless, the 'NF line of the 71 Series provides pushbuttons, thermostats and plates for sockets in plastic, metal and Fenix NTM®, the super opaque and soft touch nanotechnological material. Equipped with LEDs with adjustable light intensity in blue/green or white/red combinations.

**Available colour solutions**

	Form	Flank	'NF	Deep	Surface
<b>Plastic</b>	•	•	•	-	-
<b>Metal</b>	•	•	•	•	•
<b>Fenix NTM®</b>	•	-	•	•	•

For more information see page 161

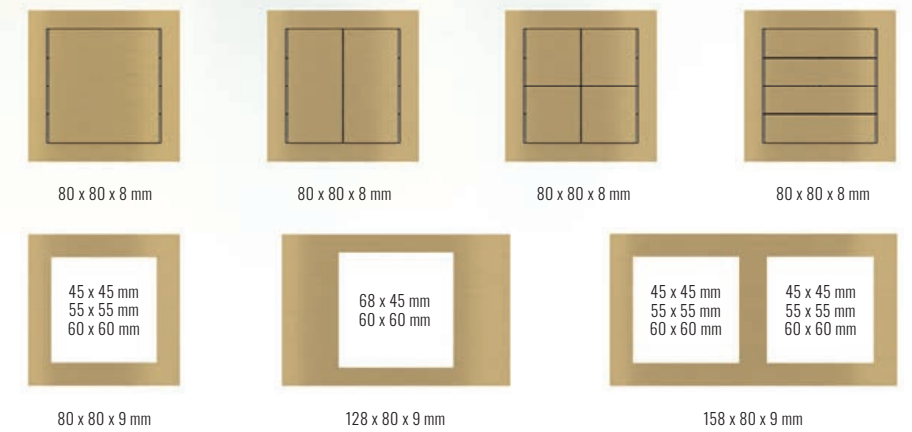



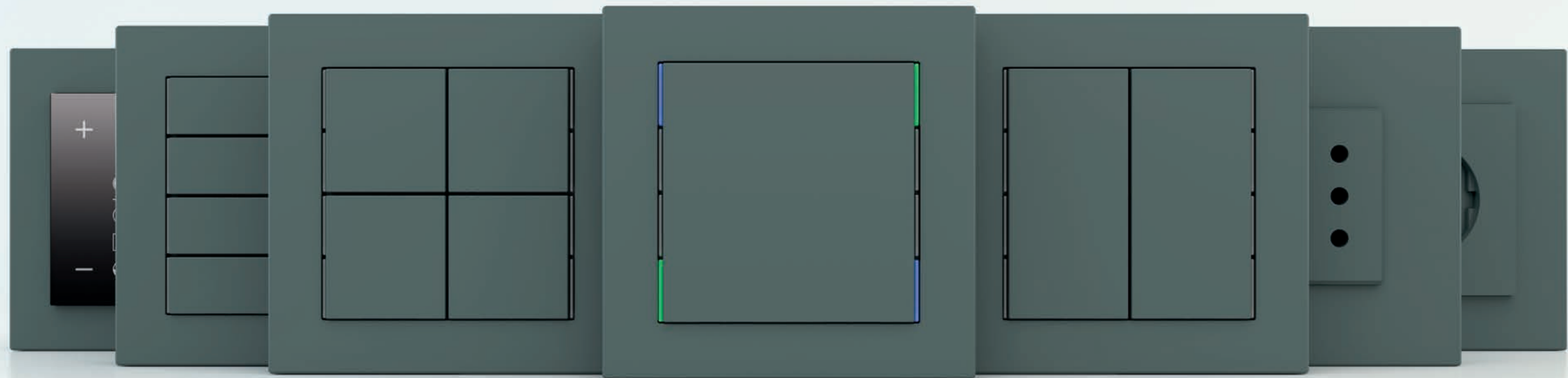

## 71 - Deep

WALL-MOUNT DEVICES - 71 SERIES

**Slim and elegant.** The Deep line of the 71 series provides plastic, metal and Fenix NTM® pushbuttons, thermostats and plates for sockets in a wide range of colours and sizes with integrated LEDs that can be freely combined with each other. Ideal for even the most eclectic and elegantly designed spaces.

**Available colour solutions**

	Form	Flank	'NF	Deep	Surface
<b>Plastic</b>	•	•	•	-	-
<b>Metal</b>	•	•	•	•	•
<b>Fenix NTM®</b>	•	-	•	•	•

For more information see page 161

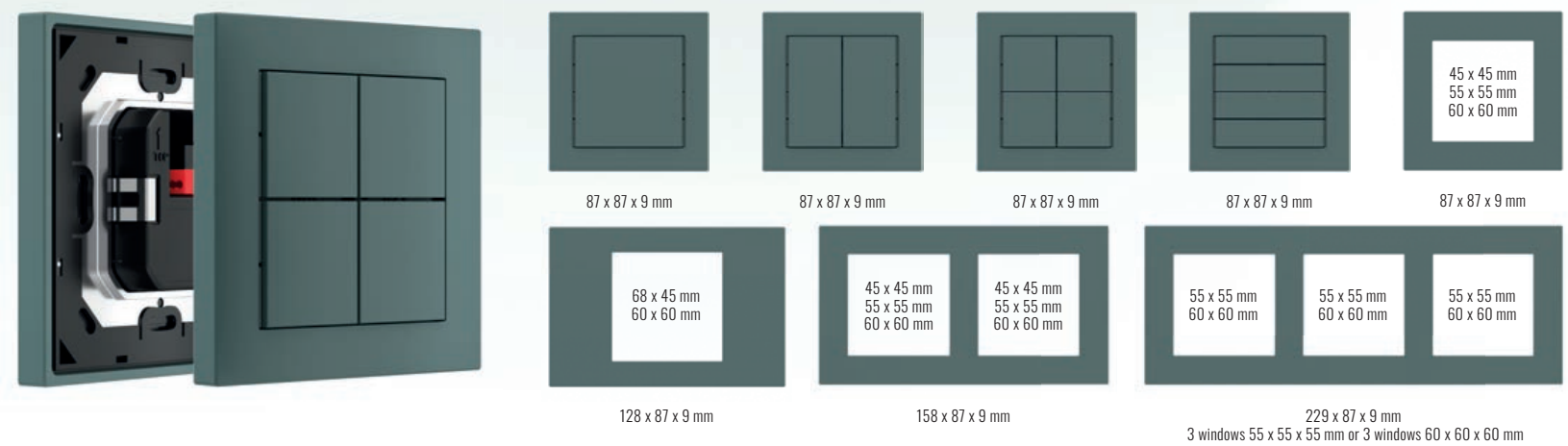

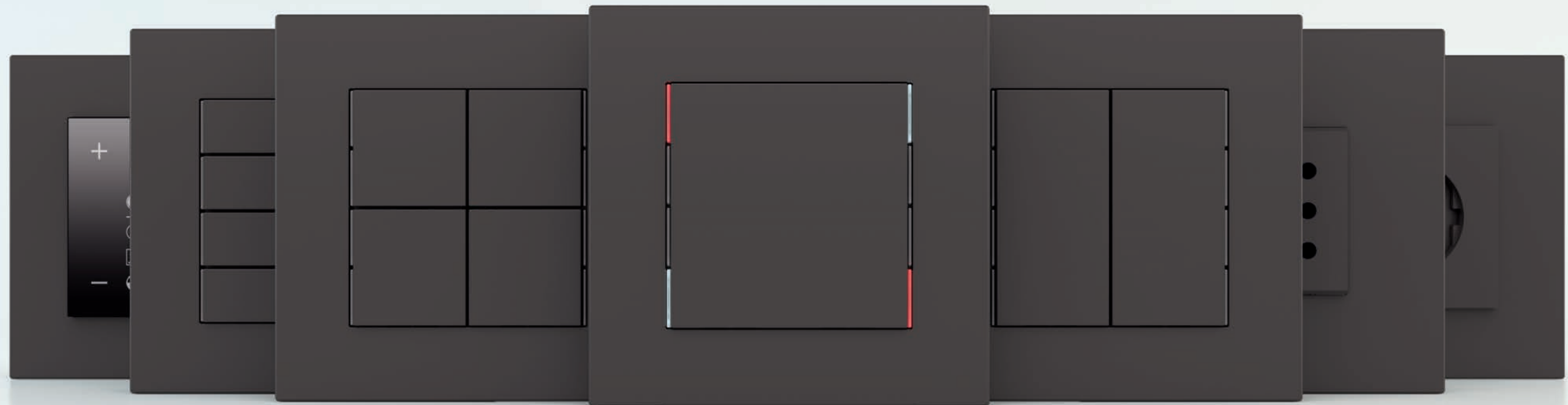

## 71 - Surface

WALL-MOUNT DEVICES - 71 SERIES

**Essentiality and functionality for the contemporary home.** Designed to create a continuum with the wall, the Surface line of the 71 series integrates with the background almost as if it were part of it. The different available combinations make it particularly versatile and successful in the most different situations. The materials used are metal and the nanotechnological Fenix NTM®.

**Available colour solutions**

	Form	Flank	'NF	Deep	Surface
<b>Plastic</b>	•	•	•	-	-
<b>Metal</b>	•	•	•	•	•
<b>Fenix NTM®</b>	•	-	•	•	•

For more information see page 161

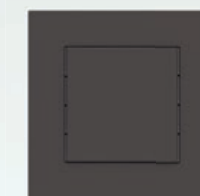

98 x 98 x 3 mm

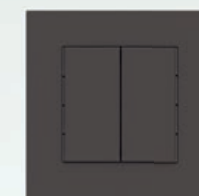

98 x 98 x 3 mm

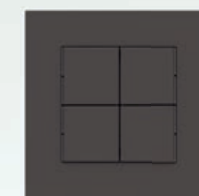

98 x 98 x 3 mm



98 x 98 x 3 mm

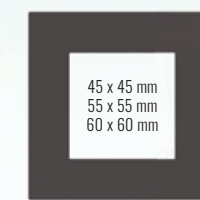

45 x 45 mm  
55 x 55 mm  
60 x 60 mm

98 x 98 x 3 mm

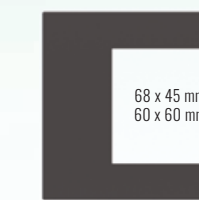

68 x 45 mm  
60 x 60 mm

133 x 98 x 3 mm

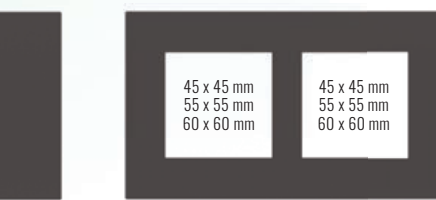

45 x 45 mm  
55 x 55 mm  
60 x 60 mm

45 x 45 mm  
55 x 55 mm  
60 x 60 mm

168 x 98 x 3 mm



# Pushbuttons - 71 series

WALL-MOUNT DEVICES

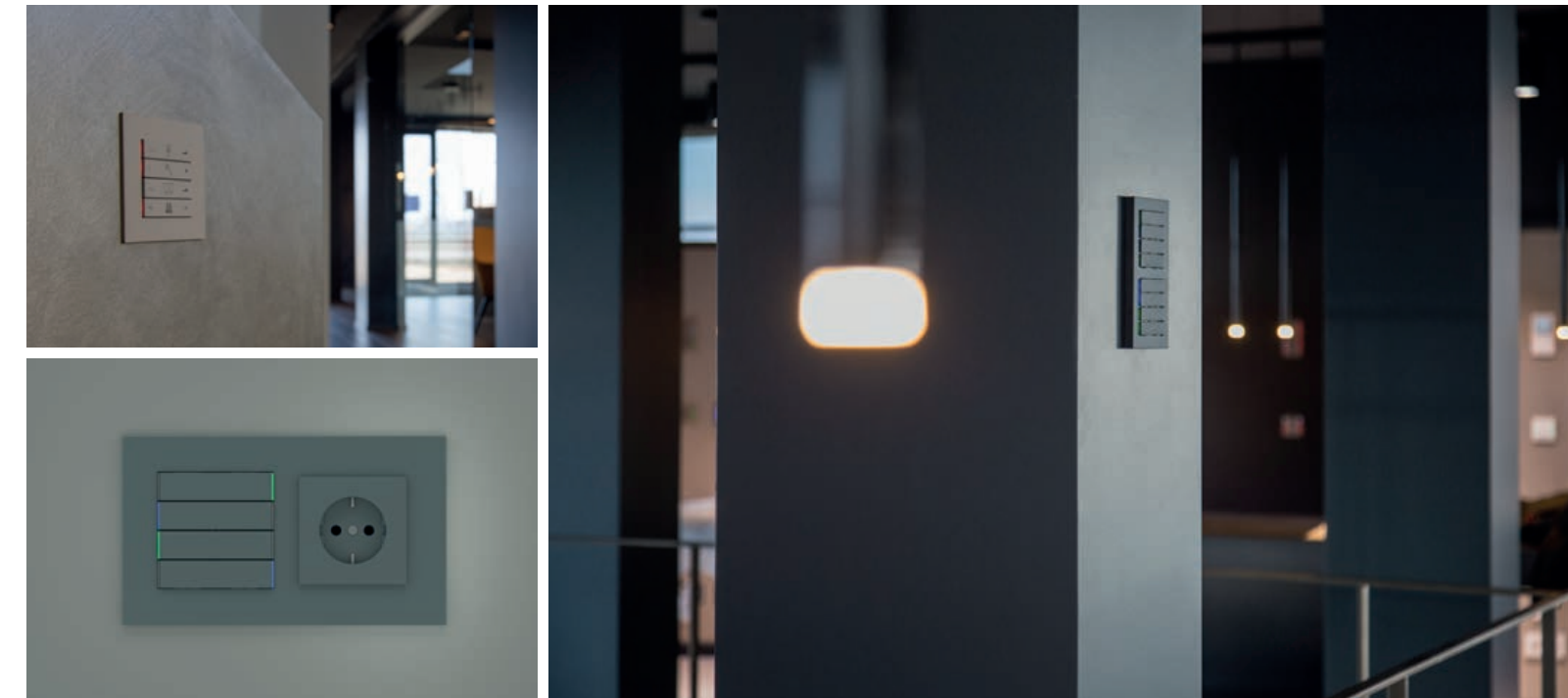
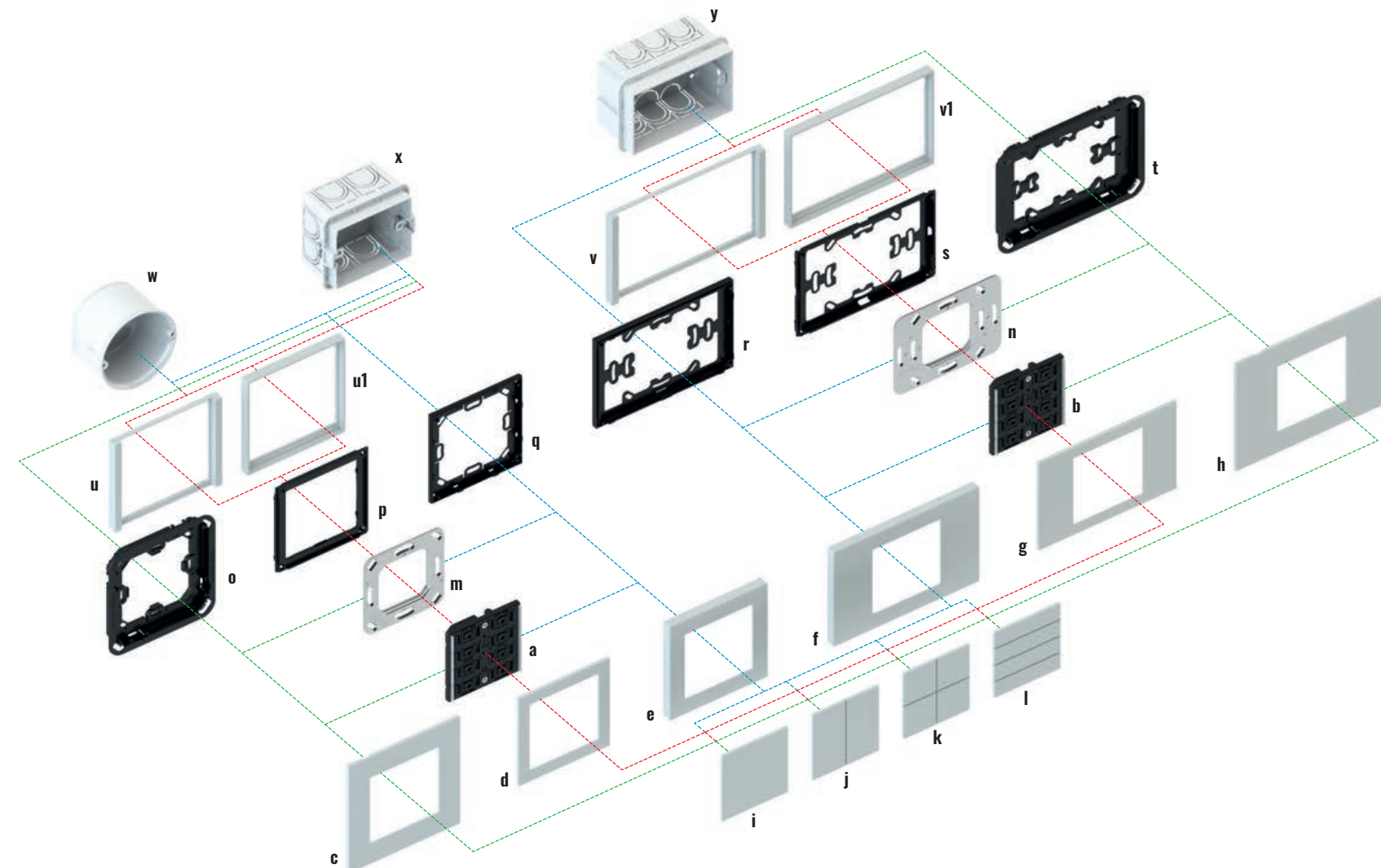

**71 series: infinite number of combinations for a unique style. The series of 71 buttons are available in square or rectangular version with single, double or triple window (Deep version only).**

The Ekinex® pushbuttons of 71 series range and related accessories offer the possibility to realize several variations that will satisfy the most diverse needs. The base is represented by the device which is fitted with a KNX communication module. The EK-E12-TP version (a) of the pushbutton is suitable for mounting into a flush mounting box, either round (w) or square (x), provided with fixing holes 60 mm apart, while the EK-E12-TP-...-R version (b) is also suitable for mounting into a rectangular wall mounting box (y) 3 seater according to the Italian installation standard provided with fixing holes 83,5 mm apart. Each pushbutton is delivered with its relative metal support (m, n) which, in case of necessity, can also be ordered separately. A plastic adapter and a terminal block complete the supply.

The pushbuttons must be finished off with an operation surface (rockers), a plate with 60 x 60 mm window (c, d, e, f, g, h) and a frame. The rockers are available in square (i, k) and rectangular (j, l) shapes of different modularities, in plastic material, aluminium or Fenix NTM® and in several colours. Version EK-E12-TP has integrated LEDs which can be programmed freely: as an example, as a status feedback or as an orientation light at night time. Two colour combinations are available for the LEDs: blue / green or red / white. The same version also offers a room thermostat function, thanks to the integrated temperature sensor. The frames, square (u, u1) and rectangular (v, v1), are available in two stylish alternatives (Form and Flank) and are available in plastic material or aluminium and in several colours and finishings. The 'NF' version of the pushbutton is mounted without frame and is provided with a side profile in white or black colour.

The pushbuttons simply get connected to the unique signal bus cable and do not require auxiliary power supply; the devices are supplied at SELV (Safety Extra Low Voltage) voltage, thus offering a much higher safety level than traditional commands. The configuration and commissioning is carried out by means of the ETS® software. The related application programs can be downloaded from the [www.ekinex.com](http://www.ekinex.com) website.

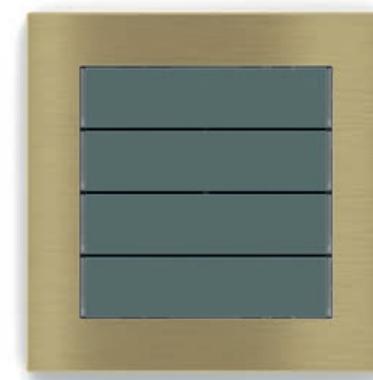

### Pushbuttons 71 series

Description	Code	Page
a) Pushbutton 71 series	EK-E12-... or EK-E22-...	90-92
b) Pushbutton 71 series for rectangular 3-module box	EK-E12-...-R or EK-E22-...-R	91-93
c) Square plate Surface series*	EK-SQS-...	143
d) Square plate*	EK-PQS-...	136
e) Square plate Deep series*	EK-DQP-...	139
f) Rectangular plate Deep series*	EK-DRS-...	140
g) Rectangular plate*	EK-PRS-...	137
h) Rectangular plate Surface series*	EK-SRS-...	144
i) Square rocker (1)	EK-T1Q-...	117
j) Rectangular vertical rockers (2)	EK-T2R-...	117
k) Square rockers (4)	EK-T4Q-...	117
l) Rectangular horizontal rockers (4)	EK-T4R-...	117
m) Metal mounting support	EK-SMQ-71	153
n) Metal mounting support with adapter**	EK-SMR-71	153

Description	Code	Page
o) Adapter for square Surface plate	EK-TAS-Q-...-NF	143
p) Adapter for square plate - Form or Flank frames**	EK-TAQ-...	136
q) Adapter for square plate 'NF and Deep series	EK-TAQ-...-NF	136-139
r) Adapter for rectangular plate 'NF and Deep series	EK-TAR-...-NF	137-140
s) Adapter for rectangular plate - Form or Flank frames**	EK-TAR-...	137
t) Adapter for Surface rectangular plate	EK-TAS-R-...	143
u) Square frame Flank series	EK-FLQ-...	134
u1) Square frame Form series	EK-FOQ-...	133
v) Rectangular frame Flank series	EK-FLR-...	134
v1) Rectangular frame Form series	EK-FOR-...	133
w) Round flush-mounting box	not delivered by Ekinex®	
x) Square flush-mounting box	not delivered by Ekinex®	
y) Rectangular flush-mounting box (3 modules)	not delivered by Ekinex®	

\*) 60 x 60 mm window

\*\*) Included with the purchase of the related 71 series pushbutton

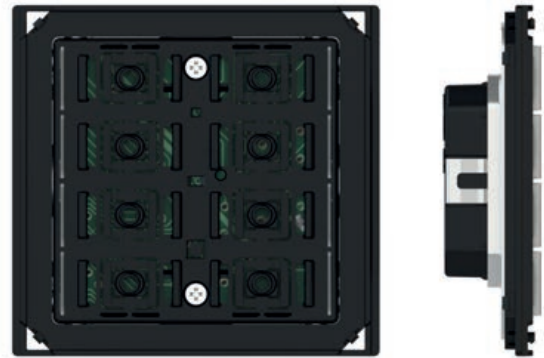

## 4-fold basic pushbutton - 71 series

WALL-MOUNT DEVICES

### Description

The 4-fold pushbutton of Ekinex® 71 series commands loads on/off switching, controls the dimming of lighting devices, controls motor drives for shutters or executes any other programmable command and control function. The device integrates a KNX bus communication module and is intended for mounting onto a wall mounting box: it is supplied by a SELV voltage directly from the KNX bus and does not require any auxiliary power supply.

### Main features

- 4-fold (possibility to configure up to 8 independent functions)
- Plastic casing
- Connection to bus line with KNX terminal block
- Frontal programming pushbutton and LED
- Wall-mounting installation on round or square wall box
- IP20 protection degree (installed)
- Weight 70 g (with mounting support)

### Technical data

- 30 Vdc power supply by KNX bus
- Current consumption from bus < 15 mA

### Products included

Delivery includes a terminal block for connection to the bus, a metal support for installation onto round or square mounting box (fixing holes 60 mm apart), a plastic adapter and two pairs of fixing screws.

### Accessories

- The following accessories are available to be ordered separately:
- set of 1 square rocker, 2 vertical rectangular rockers, 4 square rockers or 4 horizontal rectangular rockers
  - square frame of Form or Flank series
  - square plate with 60 x 60 mm window

### Note

Finishing a 71 series pushbutton with a square rocker with 60 x 60 mm modularity does not allow the use of the integrated brightness sensor.

### Dimensions [mm]

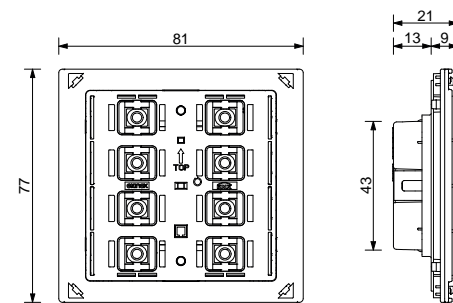

Mounting with frame: 81 x 77 (L x H)  
Mounting without frame (\*NF): 80 x 80 (L x H)



### Configuration and commissioning

By means of ETS5 software or later versions  
Application program: **APEKE22TP##.knxprod**  
(## = version, downloadable from [www.ekinex.com](http://www.ekinex.com))



### Documentation

For more information, see the **STEKE22TP\_EN.pdf**, technical sheet available for download from [www.ekinex.com](http://www.ekinex.com)



## 4-fold basic pushbutton and room thermostat for rectangular wall-box - 71 series

WALL-MOUNT DEVICES

### Description

The 4-fold pushbutton of Ekinex® 71 series commands loads on/off switching, controls the dimming of lighting devices, controls motor drives for shutters or executes any other programmable command and control function. The device integrates a KNX bus communication module and is intended for mounting onto a wall mounting box: it is supplied by a SELV voltage directly from the KNX bus and does not require any auxiliary power supply.

### Main features

- 4-fold (possibility to configure up to 8 independent functions)
- Plastic casing
- Connection to bus line with KNX terminal block
- Frontal programming pushbutton and LED
- Wall-mounting installation on round, square or rectangular wall box
- IP20 protection degree (installed)
- Weight 100 g (with mounting support)

### Technical data

- 30 Vdc power supply by KNX bus
- Current consumption from bus < 15 mA

### Products included

Delivery includes a terminal block for connection to the bus, a metal support for installation onto round or square (fixing holes 60 mm apart) or rectangular 3 seater mounting box according to the Italian installation standard provided (fixing holes 83,5 mm apart), a rectangular adapter and two pairs of fixing screws.

### Accessories

- The following accessories are available to be ordered separately:
- set of 1 square rocker, 2 vertical rectangular rockers, 4 square rockers or 4 horizontal rectangular rockers
  - rectangular frame of Form or Flank series
  - rectangular plate with 60 x 60 mm window

### Note

Finishing a 71 series pushbutton with a square rocker with 60 x 60 mm modularity does not allow the use of the integrated brightness sensor.

### Dimensions [mm]

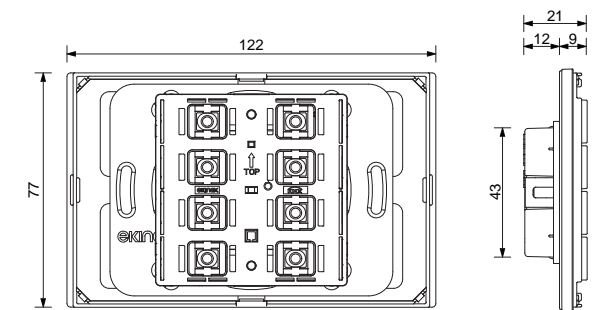

Mounting with frame: 122 x 77 (L x H)  
Mounting without frame (\*NF): 120 x 80 (L x H)

### Order information

Code	Mounting	Side profile
EK-E22-TP-R	with rectangular frame of Form or Flank series	-
EK-E22-TP-NF-R	without frame	black
EK-E22-TP-NFW-R	(*NF series)	white

Also available in multiple pack of 8 pcs.



### Configuration and commissioning

By means of ETS5 software or later versions  
Application program: **APEKE22TP##.knxprod**  
(## = version, downloadable from [www.ekinex.com](http://www.ekinex.com))



### Documentation

For more information, see the **STEKE22TP\_EN.pdf**, technical sheet available for download from [www.ekinex.com](http://www.ekinex.com)







## 4-fold pushbutton and room thermostat - 71 series

WALL-MOUNT DEVICES

### Description

The 4-fold pushbutton of Ekinex® 71 series commands loads on/off switching, controls the dimming of lighting devices, controls motor drives for shutters or executes any other programmable command and control function. Thanks to the integrated temperature sensor, the pushbutton can work as a thermostat for a room or a zone. The LED can be chosen in the colour combinations blue / green or white / red. The device integrates a KNX bus communication module and is intended for mounting onto a wall mounting box; it is powered by a SELV voltage directly from the KNX bus and does not require any auxiliary power supply.

### Main features

- 4-fold (possibility to configure up to 8 independent functions)
- 4 freely programmable LED for each channel
- 2 colour combination available for the LED (blue / green or red / white)
- Room thermostat function
- Integrated temperature sensor
- Plastic casing
- Connection to bus line with KNX terminal block
- Frontal programming pushbutton and LED
- Wall-mounting installation on round or square wall box
- IP20 protection degree (installed)
- Weight 70 g (with mounting support)

### Technical data

- 30 Vdc power supply by KNX bus
- Current consumption from bus < 15 mA

### Products included

Delivery includes a terminal block for connection to the bus, a metal support for installation onto round or square mounting box (fixing holes 60 mm apart), a plastic adapter and two pairs of fixing screws.

### Accessories

The following accessories are available to be ordered separately:

- set of 1 square rocker, 2 vertical rectangular rockers, 4 square rockers or 4 horizontal rectangular rockers
- square frame of Form or Flank series
- square plate with 60 x 60 mm window

### Dimensions [mm]

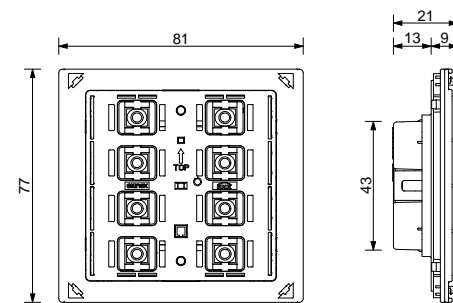

Mounting with frame: 81 x 77 (L x H)  
Mounting without frame (NF): 80 x 80 (L x H)



### Configuration and commissioning

By means of ETS5 software or later versions  
Application program: **APEKE12TP##.knxprod**  
(## = version, download from [www.ekinex.com](http://www.ekinex.com))



### Documentation

For more information, see the **STEKE12TP\_EN.pdf**, technical sheet available for download from [www.ekinex.com](http://www.ekinex.com)



### Order information

Code	LED colours	Mounting	Side profile
EK-E12-TP	blue / green	with square frame of Form or Flank series	-
EK-E12-TP-RW	red / white	with square frame of Form or Flank series	-
EK-E12-TP-BG-NF	blue / green	without frame (NF series)	black
EK-E12-TP-RW-NF	red / white	without frame (NF series)	black
EK-E12-TP-BG-NFW	blue / green	without frame (NF series)	white
EK-E12-TP-RW-NFW	red / white	without frame (NF series)	white

Also available in multiple pack of 8 pcs.



## 4-fold pushbutton and room thermostat for rectangular wall-box - 71 series

WALL-MOUNT DEVICES

### Description

The 4-fold pushbutton of Ekinex® 71 series commands loads on/off switching, controls the dimming of lighting devices, controls motor drives for shutters or executes any other programmable command and control function. Thanks to the integrated temperature sensor, the pushbutton can work as a thermostat for a room or a zone. The LED can be chosen in the colour combinations blue / green or white / red. The device integrates a KNX bus communication module and is intended for mounting onto a wall mounting box; it is powered by a SELV voltage directly from the KNX bus and does not require any auxiliary power supply.

### Main features

- 4-fold (possibility to configure up to 8 independent functions)
- 4 freely programmable LED for each channel
- 2 colour combination available for the LED (blue / green or red / white)
- Room thermostat function
- Integrated temperature sensor
- Plastic casing
- Connection to bus line with KNX terminal block
- Frontal programming pushbutton and LED
- Wall-mounting installation on round, square or rectangular wall box
- IP20 protection degree (installed)
- Weight 100 g (with mounting support)

### Technical data

- 30 Vdc power supply by KNX bus
- Current consumption from bus < 15 mA

### Products included

Delivery includes a terminal block for connection to the bus, a metal support for installation onto round or square (fixing holes 60 mm apart) or rectangular 3 seater mounting box according to the Italian installation standard provided (fixing holes 83,5 mm apart), a rectangular adapter and two pairs of fixing screws.

### Accessories

The following accessories are available to be ordered separately:

- set of 1 square rocker, 2 vertical rectangular rockers, 4 square rockers or 4 horizontal rectangular rockers
- rectangular frame of Form or Flank series
- rectangular plate with 60 x 60 mm window

### Dimensions [mm]

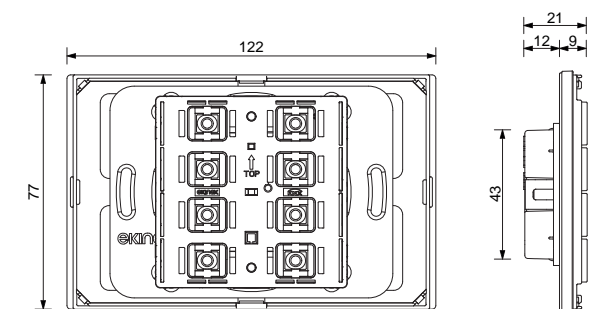

Mounting with frame: 122 x 77 (L x H)  
Mounting without frame (NF): 120 x 80 (L x H)



### Configuration and commissioning

By means of ETS5 software or later versions  
Application program: **APEKE12TP##.knxprod**  
(## = version, download from [www.ekinex.com](http://www.ekinex.com))



### Documentation

For more information, see the **STEKE12TP\_EN.pdf**, technical sheet available for download from [www.ekinex.com](http://www.ekinex.com)



### Order information

Code	LED colours	Mounting	Side profile
EK-E12-TP-R	blue / green	with rectangular frame of Form or Flank series	-
EK-E12-TP-RW-R	red / white	with rectangular frame of Form or Flank series	-
EK-E12-TP-BG-NF-R	blue / green	without frame (NF series)	black
EK-E12-TP-RW-NF-R	red / white	without frame (NF series)	black
EK-E12-TP-BG-NFW-R	blue / green	without frame (NF series)	white
EK-E12-TP-RW-NFW-R	red / white	without frame (NF series)	white

Also available in multiple pack of 8 pcs.



## Room thermostats

WALL-MOUNT DEVICES - 71 SERIES

**Create a positive atmosphere.** The different operating modes of the 71 series room temperature control allow you to adapt the control to your needs, save energy and ensure your comfort. The numerous integrated functions ensure a comfortable environment in all seasons. The 71 room temperature control will make you want to come back home.

### Available colour solutions

	Form	Flank	'NF	Deep	Surface
Plastic	•	•	•	-	-
Metal	•	•	•	•	•
Fenix NTM®	•	-	•	•	•

For more information see page 161



86 x 86 x 8 mm  
**Form**



94 x 86 x 8 mm  
**Flank**



80 x 80 x 8 mm  
**'NF**



86 x 86 x 9 mm  
**Deep**



98 x 98 x 3 mm  
**Surface**



# Room thermostats - 71 series

WALL-MOUNT DEVICES

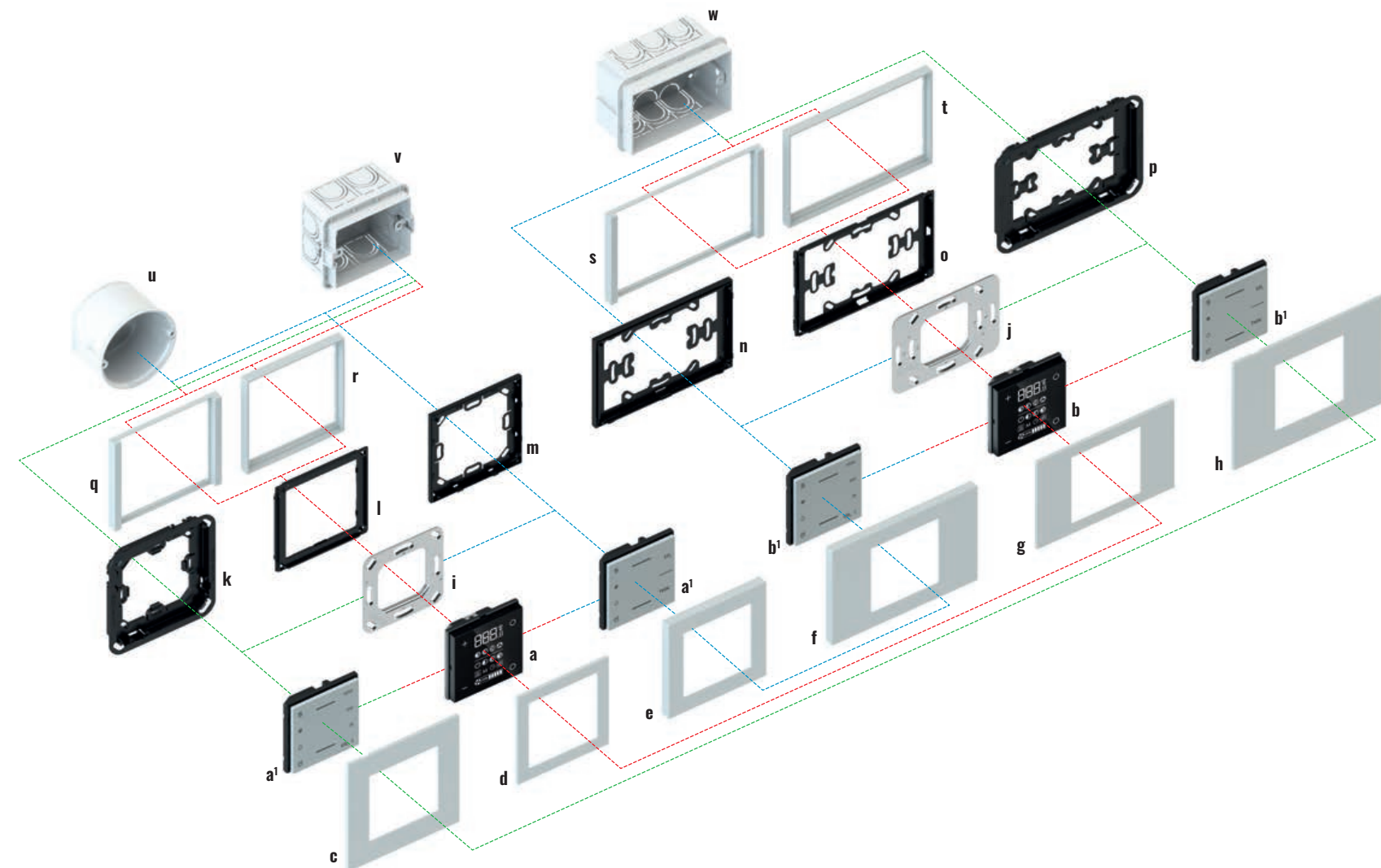

Many different combinations, possibilities installation horizontally or vertically, 71 room temperature control meets all requirements. Yours too...

The Ekinex® thermostats of 71 series range and related accessories offer the possibility to realize several variations that will satisfy the most diverse needs. The base is represented by the device which is fitted with a KNX communication module. The EK-E72-TP version (a) of the thermostat is suitable for mounting into a flush mounting box, either round (u) or square (v), provided with fixing holes 60 mm apart, while the EK-E72-TP-...-R version (b) is also suitable for mounting into a rectangular wall mounting box (w) 3 modules according to the Italian installation standard provided with fixing holes 83,5 mm apart. Each thermostat is delivered with its relative metal support (i, j) which, in case of necessity, can also be ordered separately. A plastic adapter and a terminal block complete the supply.

Depending on the version, the thermostat must be finished off with a square (c, d, e) or rectangular (f, g, h) plate with 60 x 60 mm window and a square (q, r) or rectangular (s, t) frame. The frames are available in two stylish alternatives (Form and Flank). Plates and frames are in plastic material, aluminium or Fenix NTM®, in several colour and finishing variations. The 'NF' versions of the thermostats are mounted without frame and are provided with a side profile in white or black colour.

The thermostats simply get connected to the unique signal bus cable and do not require auxiliary power supply; the devices are powered at SELV (Safety Extra Low Voltage) voltage, thus offering a much higher safety level than traditional commands. The configuration and commissioning is carried out by means of the ETS® software. The related application programs can be downloaded from the www.ekinex.com website.



### Room thermostats and Multisensors 71 series

Description	Code	Page
a) Thermostat 71 series	EK-E72-TP-...	98
b) Thermostat 71 series for rectangular 3-module box	EK-E72-TP-...-R	99
a1) Multisensor 71 series	EK-ET2-... or EK-ES2-...	100-102
b1) Multisensor 71 series for rectangular 3-module box	EK-ET2-...-R or EK-ES2-...-R	101-103
c) Square plate Surface series*	EK-SQS-...	143
d) Square plate*	EK-PQS-...	136
e) Square plate Deep series*	EK-DQP-...	139
f) Rectangular plate Deep series*	EK-DRS-...	140
g) Rectangular plate*	EK-PRS-...	137
h) Rectangular plate Surface series*	EK-SRS-...	144
i) Metal mounting support	EK-SMQ-71	153
j) Metal mounting support with adapter**	EK-SMR-71	153
k) Adapter for square Surface plate	EK-TAS-Q-...-NF	143
l) Adapter for square plate - Form or Flank frames**	EK-TAQ-...	136

Description	Code	Page
m) Adapter for square plate 'NF and Deep series	EK-TAQ-...-NF	136-139
n) Adapter for rectangular plate 'NF and Deep series	EK-TAR-...-NF	137-140
o) Adapter for rectangular plate - Form or Flank frames**	EK-TAR	137
p) Adapter for Surface rectangular plate**	EK-TAS-R-...	144
q) Square frame Flank series	EK-FLQ-...	134
r) Square frame Form series	EK-FOQ-...	133
s) Rectangular frame Flank series	EK-FLR-...	134
t) Rectangular frame Form series	EK-FOR-...	133
u) Round flush-mounting box	not delivered by Ekinex®	
v) Square flush-mounting box	not delivered by Ekinex®	
w) Rectangular flush-mounting box (3 modules)	not delivered by Ekinex®	
*) 60 x 60 mm window		
**) Included with the purchase of the related 71 series pushbutton		



## Room thermostat - 71 series

WALL-MOUNT DEVICES

### Description

The Ekinex® room temperature controller of 71 series regulates independently the temperature of a room or a zone. In combination with one or more KNX actuators, the room temperature controller is able to control the heating and cooling emission of a series of terminal units for the thermal exchange (such as radiators, fan-coils, floor and ceiling radiant panels, etc.). The device is provided with a LCD-Display with adjustable backlight, and a sensor for temperature measuring. The device integrates a KNX bus communication module and is intended for mounting onto a wall mounting box; it is powered by a SELV voltage directly from the KNX bus and does not require any auxiliary power supply.

### Main features

- LCD-Display with adjustable backlight
- 4 capacitive pushbuttons for controlling of the thermostat functions
- Integrated temperature sensor
- Plastic casing
- Connection to bus line with KNX terminal block
- Frontal programming pushbutton and LED
- Wall-mounting installation on round or square wall box
- IP20 protection degree (installed)
- Weight 90 g (with mounting support)

### Technical data

- 30 Vdc power supply by KNX bus
- Current consumption from bus < 13 mA

### Products included

Delivery includes a terminal block for connection to the bus, a metal support for installation onto round or square mounting box (fixing holes 60 mm apart), a plastic adapter, two fixing screws and two rubber screw covers.

### Accessories

The following accessories are available to be ordered separately:

- square frame of Form or Flank series
- square plate with 60 x 60 mm window

### Dimensions [mm]

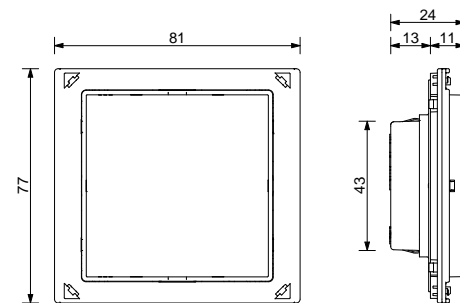

Mounting with frame: 81 x 77 (L x H)  
Mounting without frame ('NF'): 80 x 80 (L x H)



### Configuration and commissioning

By means of ETS5 software or later versions  
Application program: **APEKE72TP##.knxprod**  
(## = version, download from [www.ekinex.com](http://www.ekinex.com))



### Documentation

For more information, see the **STEKE72TP\_EN.pdf**, technical sheet available for download from [www.ekinex.com](http://www.ekinex.com)



## Room thermostat for rectangular wall-box - 71 series

WALL-MOUNT DEVICES

### Description

The Ekinex® room temperature controller of 71 series regulates independently the temperature of a room or a zone. In combination with one or more KNX actuators, the room temperature controller is able to control the heating and cooling emission of a series of terminal units for the thermal exchange (such as radiators, fan-coils, floor and ceiling radiant panels, etc.). The device is provided with a LCD-Display with adjustable backlight, and a sensor for temperature measuring. The device integrates a KNX bus communication module and is intended for mounting onto a wall mounting box; it is powered by a SELV voltage directly from the KNX bus and does not require any auxiliary power supply.

### Main features

- LCD-Display with adjustable backlight
- 4 capacitive pushbuttons for controlling of thermostat functions
- Integrated temperature sensor
- Plastic casing
- Connection to bus line with KNX terminal block
- Frontal programming pushbutton and LED
- Wall-mounting installation on round, square or rectangular wall box
- IP20 protection degree (installed)
- Weight 120 g (with mounting support)

### Technical data

- 30 Vdc power supply by KNX bus
- Current consumption from bus < 13 mA

### Products included

Delivery includes a terminal block for connection to the bus, a metal support for installation onto round or square (fixing holes 60 mm apart) or rectangular 3 seater mounting box according to the Italian installation standard provided (fixing holes 83,5 mm apart), a rectangular adapter and two pairs of fixing screws.

### Accessories

The following accessories are available to be ordered separately:

- rectangular frame of Form or Flank series
- rectangular plate with 60 x 60 mm window

### Dimensions [mm]

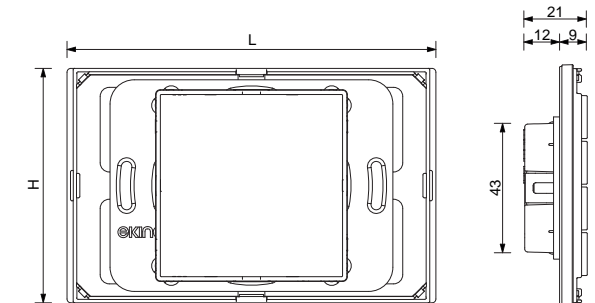

Mounting with frame: 122 x 77 (L x H)  
Mounting without frame ('NF'): 120 x 80 (L x H)



### Configuration and commissioning

By means of ETS5 software or later versions  
Application program: **APEKE72TP##.knxprod**  
(## = version, download from [www.ekinex.com](http://www.ekinex.com))



### Documentation

For more information, see the **STEKE72TP\_EN.pdf**, technical sheet available for download from [www.ekinex.com](http://www.ekinex.com)







## Multisensor quality air with regulator

WALL-MOUNT DEVICES

### Description

The Ekinex® multisensor 71 series detects values of temperature, relative humidity and CO<sub>2</sub> equivalent concentration in an air mass. The device can act as a temperature regulator of a room or zone; it can also perform the regulation by thresholds of relative humidity and CO<sub>2</sub> concentration. The frontal LEDs indicate if the device is in heating, cooling, dehumidification or CO<sub>2</sub> threshold mode. The device integrates a KNX bus communication module and is intended for mounting onto a wall mounting box; it is supplied by a SELV voltage directly from the KNX bus and does not require any auxiliary power supply.

### Main features

- Integrated temperature and relative humidity sensors
- Integrated VOCs (Volatile Organic Compounds) sensor with output signal for CO<sub>2</sub> equivalent
- Room thermostat function
- Threshold regulator function for relative humidity and CO<sub>2</sub>
- LEDs for heating, cooling, dehumidification or CO<sub>2</sub> threshold mode indication
- Plastic casing
- Connection to bus line with KNX terminal block
- Frontal programming pushbutton and LED
- Wall-mounting installation on round or square wall box
- IP20 protection degree (installed)
- Weight 90 g (with mounting support)

### Technical data

- 30 Vdc power supply by KNX bus
- Current consumption from bus < 13 mA

### Products included

Delivery includes a terminal block for connection to the bus, a metal support for installation onto round or square mounting box (fixing holes 60 mm apart), a plastic adapter and two pairs of fixing screws.

### Accessories

The following accessories are available to be ordered separately:

- 1 full front cover with 60 x 60 mm modularity
- square frame of Form or Flank series
- square plate with 60 x 60 mm window

### Dimensions [mm]

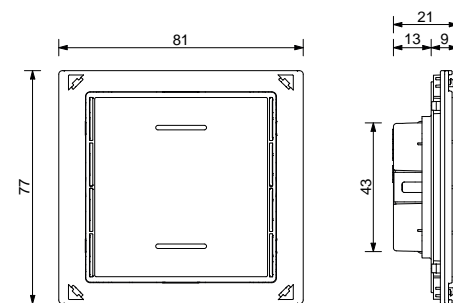

Mounting with frame: 81 x 77 (L x H)  
Mounting without frame ('NF'): 80 x 80 (L x H)



### Configuration and commissioning

By means of ETS5 software or later versions  
Application program: **APEKET2TP##.knxprod**  
(## = version, downloadable from [www.ekinex.com](http://www.ekinex.com))



### Documentation

For more information, see the **STEKET2TP\_EN.pdf** technical sheet available for download from [www.ekinex.com](http://www.ekinex.com)



## Multisensor quality air with regulator for rectangular wall-box

WALL-MOUNT DEVICES

### Description

The Ekinex® multisensor 71 series detects values of temperature, relative humidity and CO<sub>2</sub> equivalent concentration in an air mass. The device can act as a temperature regulator of a room or zone; it can also perform the regulation by thresholds of relative humidity and CO<sub>2</sub> concentration. The frontal LEDs indicate if the device is in heating, cooling, dehumidification or CO<sub>2</sub> threshold mode. The device integrates a KNX bus communication module and is intended for mounting onto a wall mounting box; it is supplied by a SELV voltage directly from the KNX bus and does not require any auxiliary power supply.

### Main features

- Integrated temperature and relative humidity sensors
- Integrated VOCs (Volatile Organic Compounds) sensor with output signal for CO<sub>2</sub> equivalent
- Room thermostat function
- Threshold regulator function for relative humidity and CO<sub>2</sub>
- LEDs for heating, cooling, dehumidification or CO<sub>2</sub> threshold mode indication
- Plastic casing
- Connection to bus line with KNX terminal block
- Frontal programming pushbutton and LED
- Wall-mounting installation on round, square or rectangular wall box
- IP20 protection degree (installed)
- Weight 120 g (with mounting support)

### Technical data

- 30 Vdc power supply by KNX bus
- Current consumption from bus < 13 mA

### Products included

Delivery includes a terminal block for connection to the bus, a metal support for installation onto round or square (fixing holes 60 mm apart) or rectangular 3 seater mounting box according to the Italian installation standard provided (fixing holes 83,5 mm apart), a rectangular adapter and two pairs of fixing screws.

### Accessories

The following accessories are available to be ordered separately:

- 1 full front cover with 60 x 60 mm modularity
- rectangular frame of Form or Flank series
- rectangular plate with 60 x 60 mm window

### Dimensions [mm]

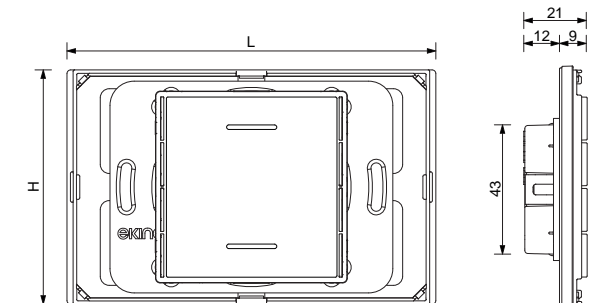

Mounting with frame: 122 x 77 (L x H)  
Mounting without frame ('NF'): 120 x 80 (L x H)



### Configuration and commissioning

By means of ETS5 software or later versions  
Application program: **APEKET2TP##.knxprod**  
(## = version, downloadable from [www.ekinex.com](http://www.ekinex.com))



### Documentation

For more information, see the **STEKET2TP\_EN.pdf** technical sheet available for download from [www.ekinex.com](http://www.ekinex.com)



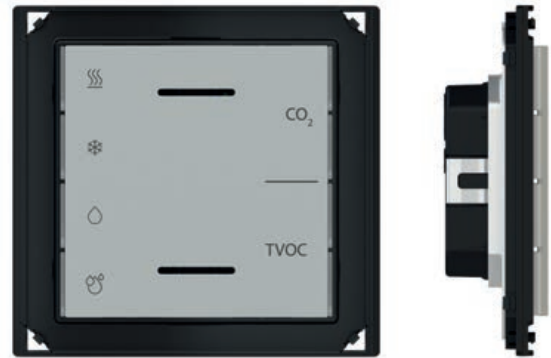

## Multisensor with humidity, TVOC and CO<sub>2</sub> eq. regulator

WALL-MOUNT DEVICES

### Description

The Ekinex® EK-ES2-TP multisensor with EK-ES2-TP controller is a KNX S-mode device for independent temperature control of a room or building area. The module includes 3 sensors: temperature, humidity percentage and air quality, expressed in terms of TVOC (Total Volatile Organic Compounds) or CO<sub>2</sub> equivalent. It can also function as a controller for these three quantities, valid for a single zone to be controlled. The front LEDs indicate the heating, cooling, dehumidification, humidification and TVOC or CO<sub>2</sub> threshold status. The push-button and the programming LED are located on the front in the area below the button. The device integrates a KNX bus communication module and is intended for mounting onto a wall mounting box: it is supplied by a SELV voltage directly from the KNX bus and does not require any auxiliary power supply.

### Main features

- Integrated temperature and relative humidity sensors
- VOC (Volatile Organic Compounds) sensor with output signal for CO<sub>2</sub> equivalent and TVOC
- Room thermostat function
- Threshold regulator function for relative humidity, TVOC and CO<sub>2</sub>
- Available an alarm signal on the CO<sub>2</sub> level also useful to obtain 1 LEED certification point
- Compatibility with Belimo actuators for the control of dampers in VAV boxes and 6-way valves
- Plastic casing
- Connection to bus line with KNX terminal block
- Frontal programming pushbutton and LED
- Wall-mounting installation on round or square wall box
- IP20 protection degree (installed)
- Weight 90 g (with mounting support)

### Technical data

- 30 Vdc power supply by KNX bus
- Current consumption from bus < 13 mA
- Max. bus power < 390 mW

### Products included

Delivery includes a terminal block for connection to the bus, a metal support for installation onto round or square mounting box (fixing holes 60 mm apart), a plastic adapter and two pairs of fixing screws.

### Accessories

- The following accessories are available to be ordered separately:
- 1 full front cover with 60 x 60 mm modularity
  - square frame of Form or Flank series
  - square plate with 60 x 60 mm window

### Dimensions [mm]

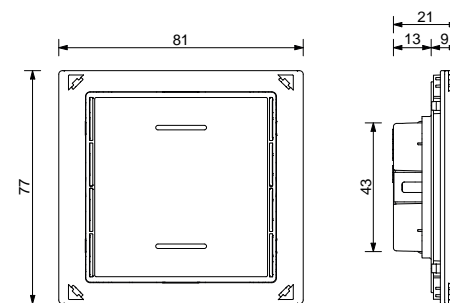

Mounting with frame: 81 x 77 (L x H)  
Mounting without frame ('NF'): 80 x 80 (L x H)



### Configuration and commissioning

By means of ETS5 software or later versions  
Application program: **APEKES2TP##.knxprod**  
(## = version, downloadable from [www.ekinex.com](http://www.ekinex.com))



### Documentation

For more information, see the **STEKES2TP\_EN.pdf**, technical sheet available for download from [www.ekinex.com](http://www.ekinex.com)

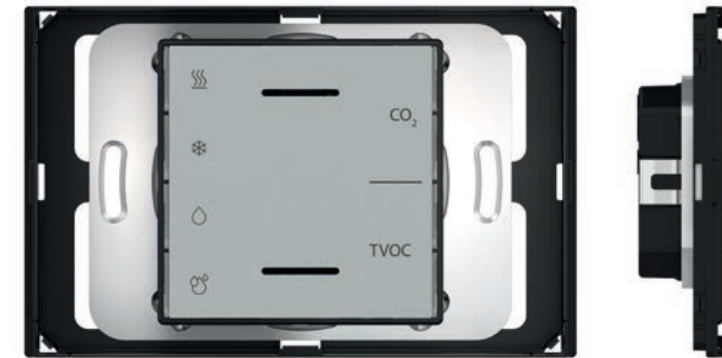

## Multisensor with humidity, TVOC and CO<sub>2</sub> eq. regulator for rectangular wall-box

WALL-MOUNT DEVICES

### Description

The Ekinex® EK-ES2-TP multisensor with EK-ES2-TP controller is a KNX S-mode device for independent temperature control of a room or building area. The module includes 3 sensors: temperature, humidity percentage and air quality, expressed in terms of TVOC (Total Volatile Organic Compounds) or CO<sub>2</sub> equivalent. It can also function as a controller for these three quantities, valid for a single zone to be controlled. The front LEDs indicate the heating, cooling, dehumidification, humidification and TVOC or CO<sub>2</sub> threshold status. The push-button and the programming LED are located on the front in the area below the button. The device integrates a KNX bus communication module and is intended for mounting onto a wall mounting box: it is supplied by a SELV voltage directly from the KNX bus and does not require any auxiliary power supply.

### Main features

- Integrated temperature and relative humidity sensors
- VOC (Volatile Organic Compounds) sensor with output signal for CO<sub>2</sub> equivalent and TVOC
- Room thermostat function
- Threshold regulator function for relative humidity, TVOC and CO<sub>2</sub>
- Available an alarm signal on the CO<sub>2</sub> level also useful to obtain 1 LEED certification point
- Compatibility with Belimo actuators for the control of dampers in VAV boxes and 6-way valves
- Plastic casing
- Connection to bus line with KNX terminal block
- Frontal programming pushbutton and LED
- Wall-mounting installation on round, square or rectangular wall box
- IP20 protection degree (installed)
- Weight 120 g (with mounting support)

### Technical data

- 30 Vdc power supply by KNX bus
- Current consumption from bus < 13 mA
- Max. bus power < 390 mW

### Products included

Delivery includes a terminal block for connection to the bus, a metal support for installation onto round or square (fixing holes 60 mm apart) or rectangular 3 seater mounting box according to the Italian installation standard provided (fixing holes 83,5 mm apart), a rectangular adapter and two pairs of fixing screws.

### Accessories

- The following accessories are available to be ordered separately:
- 1 full front cover with 60 x 60 mm modularity
  - rectangular frame of Form or Flank series
  - rectangular plate with 60 x 60 mm window

### Dimensions [mm]

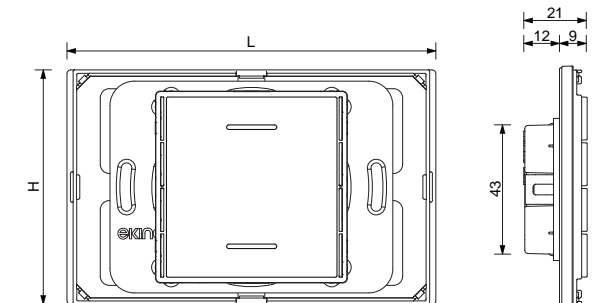

Mounting with frame: 122 x 77 (L x H)  
Mounting without frame ('NF'): 120 x 80 (L x H)



### Configuration and commissioning

By means of ETS5 software or later versions  
Application program: **APEKES2TP##.knxprod**  
(## = version, downloadable from [www.ekinex.com](http://www.ekinex.com))



### Documentation

For more information, see the **STEKES2TP\_EN.pdf**, technical sheet available for download from [www.ekinex.com](http://www.ekinex.com)





## Access control

WALL-MOUNT DEVICES

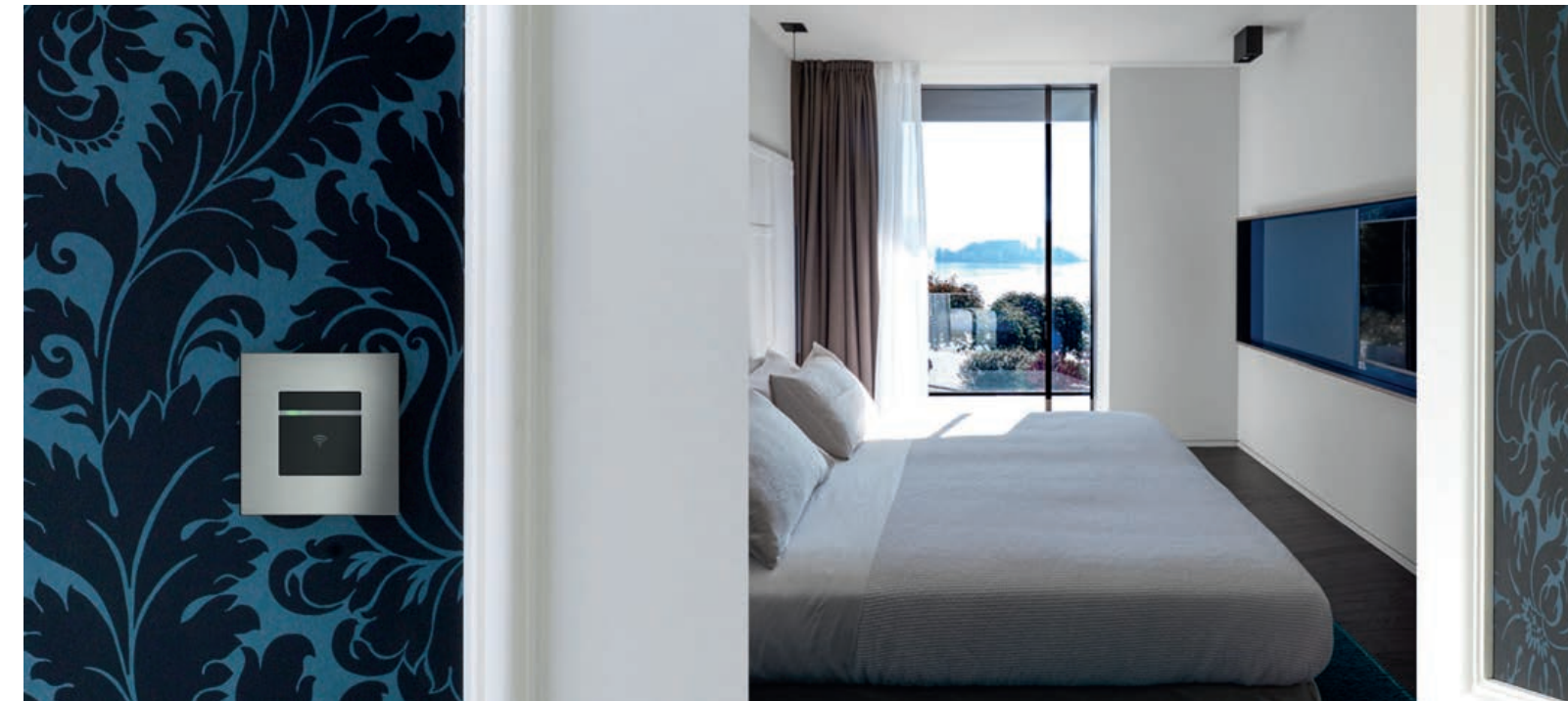
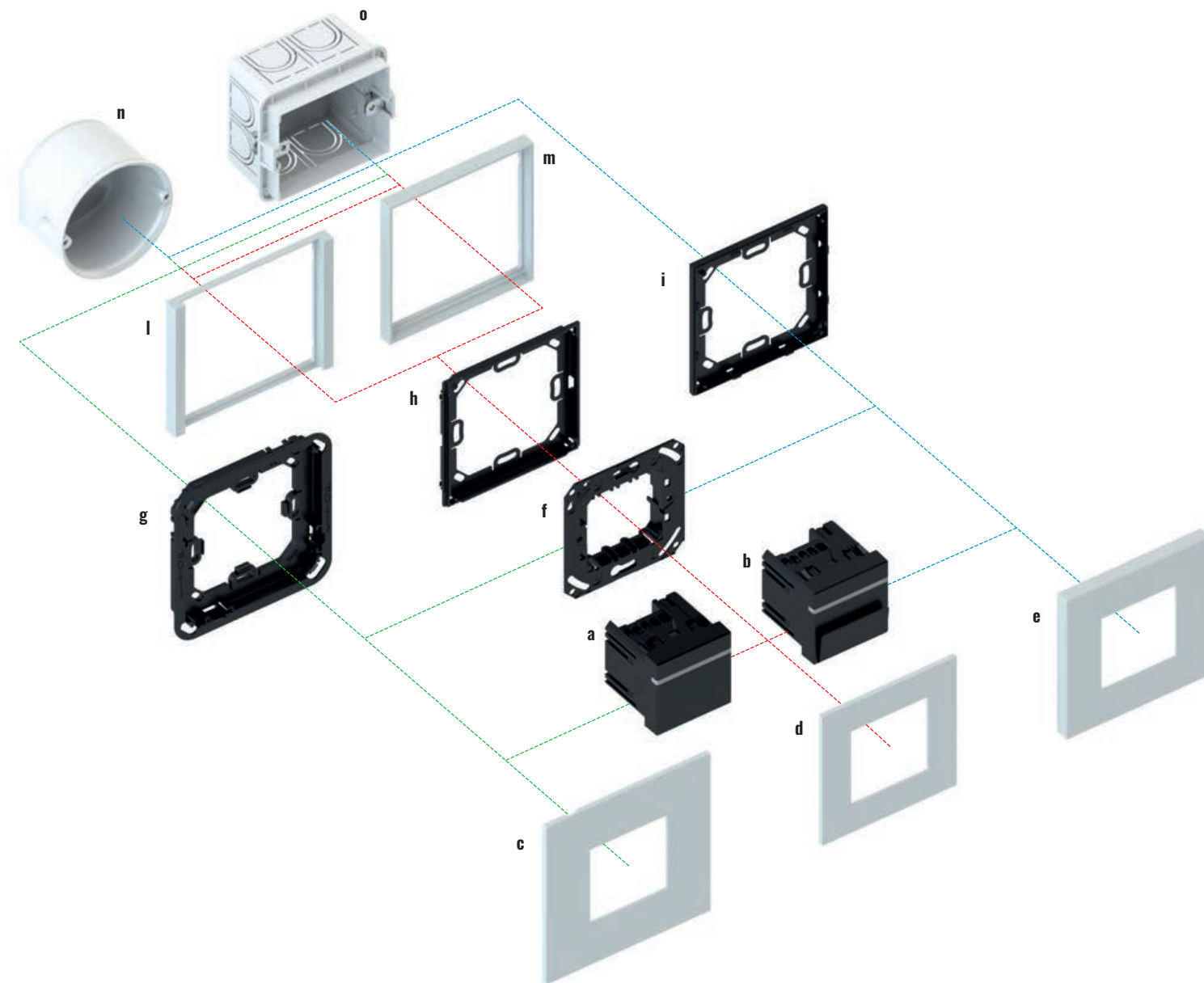

The use of Ekinex® temperature control devices in combination with the system for access and presence detection, makes it possible to offer guests of a hotel maximum comfort and, at the same time, to safeguard the objectives of energy efficiency and cost savings defined in the technical and economic planning.

KNX devices series for controlled access to rooms and for detection of presence by means of smart-cards. Ideal for creating KNX standard automation functions in hospitality and hospitality structures (hotels, residences, guesthouses or bed & breakfasts) with the aesthetic uniformity of Ekinex® wall products (push-button controls and room thermostats), in combination with products from switchboard (EK-H01-TP and EK-HU1-TP controllers) and with the Ekinex® Accédo management and supervision software.

The products are equipped with an RFID-type front antenna capable of feeding the smart-card card that is approached and reading the programmed information. The EK-TR2-TP (a) wall reader enables access following validation of the card based on the configured authorizations. The EK-TH2-TP (b) wall pocket activates presence following the insertion of the card in the appropriate front pocket. Both products can manage guest cards of the accommodation facility, based on the system codes, the reservation and the check-in / check-out period, service cards based on time slots and pass-dates. To program cards, use the product EK-TP2-TP, which is very similar to the reader with the possibility of activating the front antenna also for writing operations.

The programming of the cards in the reception area as well as the activation of a reader outside the room and an inside pocket takes place on the KNX network infrastructure. In addition to the power supplied by the KNX bus, an external auxiliary power supply is required for the RFID antenna at 12/24 Vac / dc. The basic programming of the devices as well as the configuration of the automation functions is carried out through the ETS application program: card programming and enabling room and controlled access devices in common areas requires the use of Ekinex® Accédo management and supervision software. Both devices can notify the passage and validation events of each type of card via the KNX bus with an internal buffer to cope with the unavailability of the communication bus due to excessive data traffic.



### Access control

Description	Code	Page
a) Card reader	EK-TR2-TP	106
b) Card holder	EK-TH2-TP	107
c) Square plate Surface series*	EK-SQG-...	143
d) Square plate*	EK-PQG-...	136
e) Square plate Deep series*	EK-DQG-...	139
f) Adapter for card holder and card reader	EK-SP-TX2	-
g) Adapter for Surface square plate	EK-TAS-Q-...-NF	143

Description	Code	Page
h) Adapter for square plate	EK-TAQ	136
i) Adapter for 'NF and Deep square plate	EK-TAQ-...-NF	136-139
j) Square frame of Flank series	EK-FLQ-...	134
m) Square frame of Form series	EK-FOQ-...	133
n) Round flush-mounting box	not delivered by Ekinex®	-
o) Square flush-mounting box	not delivered by Ekinex®	-

\*) 45 x 45 mm window



## Card reader

WALL-MOUNT DEVICES

### Description

The Ekinex® EK-TR2-TP card reader with RFID technology is used for access control in combination with the EK-TH2-TP card holder pocket. Equipped with a bi-stable relay (4A@24Vac/dc), an input for potential-free contacts and a 3-colour front signal LED (white, green and red). The device has an integrated KNX bus communication module and is designed for wall mounting in a flush-mounted box; it is supplied with SELV voltage via the KNX bus and requires an auxiliary power supply at 12-24 Vac/dc.

### Functionality

- Access control via KNX TP bus (twisted pair)
- Enabling access after card validation
- Management of the guest based on the booking and the check-in/check-out time; management of users based on time slots and passe-partouts
- Programmable output for electric lock activation or as simple actuator activated by KNX telegrams
- Validation in progress signalling (green led) or unauthorized card (red led); possibility of enabling the “ don't disturb” or “camera remake” commands
- Notification of validation events to supervisory system with memory buffer

### Main features

- Plastic casing
- Bus line connection via KNX terminal
- Recessed wall mounting on round box
- Degree of protection IP20 (installed)
- Weight 50 g (with mounting bracket)

### Technical data

- 30 Vdc power supply via KNX bus
- Auxiliary power supply 12-24 Vac/dc
- Current consumption from the bus < 10 mA

### Products included

Delivery includes a terminal block for connection to the bus, a metal support for installation onto round or square mounting box (fixing holes 60 mm apart), a plastic adapter and two pairs of fixing screws.

### Accessories

- The following accessories are available to be ordered separately:
- Smart-card EK-TCE-10 (ekinex logo in black, pack of 10 cards) or EK-TCC-10 (personalised with customer logo, pack of 10 cards)
  - square plate with 45 x 45 mm window

### Dimensions [mm]

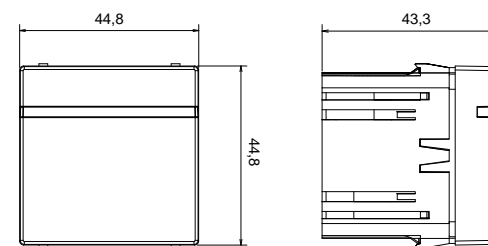

### Order information

Code	Mounting	Package
EK-TR2-TP	square plate with 45x45 mm window optional frame of Form or Flank series	1 pcs.



### Configuration and commissioning

Ekinex® Accédo software for programming access control functions and cards.  
Project file: **APEKTRPTH2TP##.knxproj** (downloadable from [www.ekinex.com](http://www.ekinex.com))



### Documentation

For more information, see the **STEKTR2TP\_EN.pdf**, technical sheet available for download from [www.ekinex.com](http://www.ekinex.com)



## Card holder

WALL-MOUNT DEVICES

### Description

The Ekinex® EK-TH2-TP card holder with RFID technology is used for presence detection in combination with the EK-TR2-TP card reader. Equipped with a bistable relay (4A@24Vac/dc), an input for potential-free contacts and a front signal LED (white). The luminaire has an integrated KNX bus communication module and is designed for wall mounting in a flush-mounted box; it is supplied with SELV voltage via the KNX bus and requires an auxiliary power supply at 12-24 Vac/dc.

### Functionality

- Presence detection via bus and communication to supervision system via KNX TP bus (twisted pair)
- Enabling presence after inserting the card into the front pocket
- Guest management of the structure according to the booking and the check-in/check-out period; user management according to time slots and passe-partouts
- Output programmable according to card validation or as actuator activated by KNX telegrams. Delay to card extraction configurable for courtesy light management
- Binary input available for connection of conventional button (with switching, dimming or roller shutter/awning function) or signal contact (e.g. window opening)
- White front LED: flashing when the card is not inserted, off when the card is inserted; LED control via KNX bus telegrams possible
- Notification of presence events detected to supervision system with memory buffer

### Main features

- Plastic casing
- Bus line connection via KNX terminal
- Recessed wall mounting on round box
- Degree of protection IP20 (installed)
- Weight 50 g (with mounting bracket)

### Technical data

- 30 Vdc power supply via KNX bus
- Auxiliary power supply 12-24 Vac/dc
- Current consumption from the bus < 10 mA

### Products included

Delivery includes a terminal block for connection to the bus, a metal support for installation onto round or square mounting box (fixing holes 60 mm apart), a plastic adapter and two pairs of fixing screws.

### Accessories

- The following accessories are available to be ordered separately:
- Smart-card EK-TCE-10 (ekinex logo in black, pack of 10 cards) or EK-TCC-10 (personalised with customer logo, pack of 10 cards)
  - square plate with 45 x 45 mm window

### Dimensions [mm]

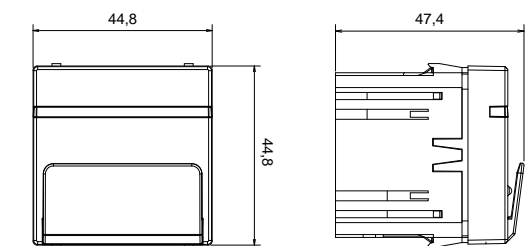

### Order information

Code	Mounting	Package
EK-TH2-TP	square plate with 45x45 mm window optional frame of Form or Flank series	1 pcs.



### Configuration and commissioning

Ekinex® Accédo software for programming access control functions and cards.  
Project file: **APEKTRPTH2TP##.knxproj** (downloadable from [www.ekinex.com](http://www.ekinex.com))



### Documentation

For more information, see the **STEKTH2TP\_EN.pdf**, technical sheet available for download from [www.ekinex.com](http://www.ekinex.com)







## Cards programmer

WALL-MOUNT DEVICES

### Description

The Ekinex® EK-TP2-TP card programmer with RFID technology is used for programming cards to be used with the EK-TR2-TP card reader and the ekinex EK-TH2-TP card holder. Equipped with a bi-stable relay (4A@24Vac/dc) and an input for potential-free contacts the device has an integrated KNX bus communication module and is designed to be mounted in a flush-mounted wall box; it is supplied with SELV voltage via the KNX bus and requires an auxiliary power supply at 12-24 Vac/dc.

### Functionality

- Programming of cards via KNX TP bus (twisted pair) and ekinex Accédo software
- Card programming with different user profiles: guest, staff and passe-partouts
- Guest booking management and check-in/check-out operation
- Card activation based on time slots for service personnel
- Event notification to the supervision system with memory buffer

### Main features

- Plastic casing
- Bus line connection via KNX terminal
- Recessed wall mounting on round box
- Degree of protection IP20 (installed)
- Weight 50 g (with mounting bracket)

### Technical data

- 30 Vdc power supply via KNX bus
- Auxiliary power supply 12-24 Vac/dc
- Current consumption from the bus < 10 mA

### Products included

Delivery includes a terminal block for connection to the bus, a metal support for installation onto round or square mounting box (fixing holes 60 mm apart), a plastic adapter and two pairs of fixing screws.

### Accessories

- The following accessories are available to be ordered separately:
- Smart-card EK-TCE-10 (ekinex logo in black, pack of 10 cards) or EK-TCC-10 (personalised with customer logo, pack of 10 cards)
  - square plate with 45 x 45 mm window

### Dimensions [mm]

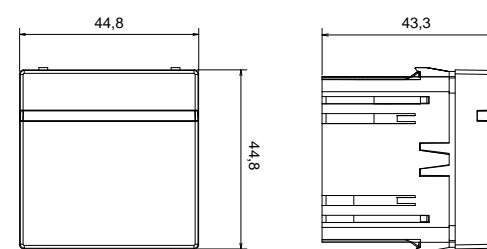

### Order information

Code	Mounting	Package
EK-TP2-TP	square plate with 45x45 mm window optional frame of Form or Flank series	1 pcs.

### Configuration and commissioning

Ekinex® Accédo software for programming access control functions and cards.  
Project file: **APEKTRPTH2TP##.knxproj** (downloadable from [www.ekinex.com](http://www.ekinex.com))

### Documentation

For more information, see the **STKTP2TP\_EN.pdf**, technical sheet available for download from [www.ekinex.com](http://www.ekinex.com)



## Desktop cards programmer kit

CONTROLLO ACCESSI

### Descrizione

The card programmer kit is a table-top control panel, coordinated with the aesthetic lines of the Ekinex® wall-mounted products, to be installed at one or more reception points in an accommodation facility, in combination with the KNX standard products for controlled access to rooms and public areas EK-TR2-TP and EK-TH2-TP and the Ekinex® Accédo EK-ACC-SW supervision and card programming software.

### Functionality

The programmer kit, suitable for reception desks in hospitality facilities such as hotels and reception centers, is equipped with an elegant frame in pre-painted aluminum in bromine gray and performs the following functions:

- Programming smart-cards with RFID (Radio Frequency Identification) technology, 13.56 MHz frequency, Mifare Classic 1kB protocol
- Signaling via buzzer of the bathroom tie rod alarms
- Alarm silencing through manual button

### Main features

- 1 KNX transponder card programmer cod. EK-TP2-TP
- 1 universal KNX interface EK-CC2-TP (2 IN / 2 OUT)
- 1 buzzer 12Vac, 5VA anthracite color
- 1 push button 1P NO, 10A at 250Vac anthracite color

The external power supply not included in the supply must be made with transformer 12Vac 1A. The card programmer and the universal interface with 2 inputs and 2 outputs must be connected to the KNX TP bus (twisted pair) by means of the red-black terminal provided.

### Other features

- card programming with RFID technology, 13.56 MHz frequency, Mifare protocolo, Classic 1 KB
- 4M table-top box, color gray, with plastic housing
- Degree of protection IP20 when installed (according to EN 60529)
- Insulation class II (according to EN 60335-1)
- Climatic classification 3K5 (indoor use, dry) and mechanical classification 3M2 (according to EN50491-2)
- Device weight: 250 g
- Dimensions 148,8 x 92 x 25,1 mm (W x H x D)

### Environmental conditions

- Operating temperature: 0°C ... + 40°C
- Storage temperature: - 10 ... + 70°C
- Transport temperature: - 10 ... + 70°C
- Relative humidity: 95% non condensing

### Dimensions [mm]

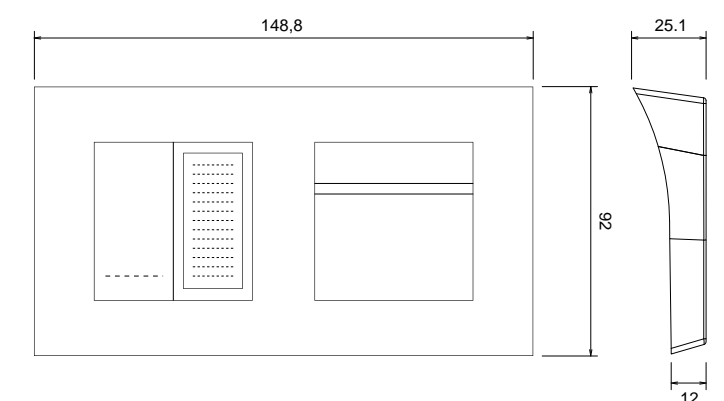

### Order information

Code	Mounting	Package
EK-TPBOX-TP	plate with 45x45 mm windows	1 pcs.

### Configuration and commissioning

Ekinex® Accédo software for programming access control functions and cards.  
Project file: **APEKTRPTH2TP##.knxproj** (downloadable from [www.ekinex.com](http://www.ekinex.com))

### Documentation

For more information, see the **STKTPBOX\_EN.pdf**, technical sheet available for download from [www.ekinex.com](http://www.ekinex.com)





## Accédo software

SOFTWARE

### Description

Software for the management of systems technology, particularly suitable for hotels, residences, guesthouses or bed&breakfast. Client-servers' architecture with HTML5 server functionality. Programming of transponder cards for access control, presence detection and (optional) electronic money functionality. Automatic import of ETS projects with easy and intuitive creation of graphic pages, drag&drop functionality, advanced copy/paste and undo/redo. Integrated control of calendars, scenarios and schedules. Interface to other communication protocols such as BACnet, Modbus, M-Bus, etc.

### Requirements

- Operating System: Windows 10 - I/O RS232
- Processor: Intel Core i5 3.3 GHz or higher
- RAM memory: min. 4 GB
- SSD: 240 GB
- Resolution: Full HD

### Order information

Code	Composition	Package
EK-ACC-L12	Software License up to 12 reader	
EK-ACC-L25	Software License up to 25 reader	
EK-ACC-L50	Software License up to 50 reader	1 pcs.
EK-ACC-L100	Software License up to 100 reader	
EK-ACC-L200	Software License up to 200 reader	
EK-ACC-LC	Client License for additional programming workstation	



### Documentation

For further information, see the manual [MAEKTSW\\_EN.pdf](#), download from [www.ekinex.com](#)



## Smart-card

ACCESSORIES

### Description

Smart-card with RFID technology to be used with the EK-TR2-TP reader and the EK-TH2-TP card holder for controlled access to rooms and for presence detection in accommodation and hospitality facilities (hotels, residences, guest houses or bed&breakfast).

### Order information

Code	Customization	Package
EK-TCE-10	Ekinex® logo in black colour	10 pcs.
EK-TCC-10	personalized with customer logo	on request



### Configuration and commissioning

The **EK-TP2-TP** card programming device and the **Ekinex® Accédo software**, dedicated to the management of accommodation and hospitality facilities, are required for card programming.



## Tosibox® Lock router

REMOTE ASSISTANCE

### Description

It establish a secure connection via VPN (Virtual Private Network) tunnel with an automation system. The connection can be made via a PC or with one or more iOS or Android smartphone users. If a KNX/IP interface/router is installed on the KNX standard automation system, it can be accessed remotely directly via ETS. Quick and easy physical association between the Lock module and the Key and realization of a point-to-point VPN via the MatchMaking service. Remote connection of installations with Internet connection with dynamic, static and private IP. Possibility to connect modems with 2G/3G/4G radiotelephone network.

### Dimensions [mm]

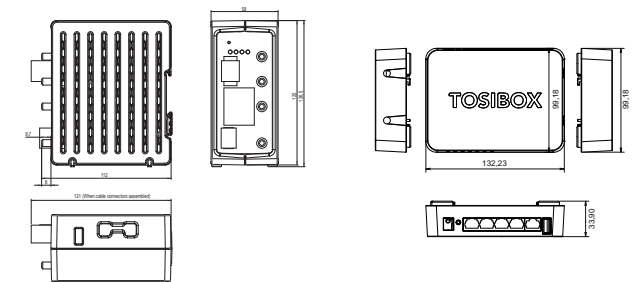

	Tosibox® Lock 150	Tosibox® Lock 500	Tosibox® Lock 500i
<b>General features</b>			
<b>Power supply</b>	12/24Vdc, with Jack, power supply included	12/48Vdc with connector, power supply not included	12/48Vdc with connector, power supply not included
<b>Installation</b>	external	DIN Rail	DIN Rail
<b>Dimension</b>	132 x 99 x 35.5 mm	110 x 58 x 127 mm	110 x 58 x 127 mm
<b>Temperature range</b>	-20 °C ... +55 °C	-20 °C ... +60 °C	-20 °C ... +60 °C
<b>Degree of protection</b>	IP20	IP20	IP20
<b>Connections</b>			
<b>WAN</b>		1xRJ45 - 10/100TX	
<b>LAN</b>		3xRJ45 - 10/100TX (one door for local service access)	
<b>WiFi</b>			Client mode e Access Point, 802.11b/g/n
<b>2G/3G/4G</b>	External modem	External modem	Integrated dual-SIM modem
<b>VPN Features</b>			
<b>VPM throughput</b>	10 Mbps	70 Mbps	70 Mbps
<b>VPN Encryption</b>		Blowfish 128 bit CBC, AES 128/192/256 bit CBC	
<b>VPN Authentication</b>		PKI, 3072 bit RSA	
<b>Certifications</b>			
	CE, FCC	CE, FCC, UL	CE, FCC, UL

### Order information

Code	Composition	Package
EK-DEL-TBL1	Tosibox® Lock 150 Router, external installation, for VPN connections with automation system	
EK-TBL5	Tosibox® Lock 500 Router, DIN rail installation, for VPN connections with automation system	1 pcs.
EK-DEL-TBL5-SIM	Tosibox® Lock 500i Router, DIN rail installation, with integrated 2G/3G/4G dual SIM modem, for VPN connections with automation system	

### Awards and recognitions





## USB Tosibox® Key

REMOTE ASSISTANCE



### Description

Quickly and securely create a Virtual Private Network (VPN) tunnel between a PC and one or more Lock routers and generate activation codes for iOS and Android VPN client apps on smartphones using 2048-bit RSA encryption. The Key can be configured as Master Key, Backup Key or Sub Key with limited access to a subset of installations. The Tosibox® SoftKey is a purely software key that can be combined with a Key to avoid transporting the physical dongle.

### Supported operating systems

- Windows 8-10 (32/64 bit)
- Windows 7 (32/64 bit)
- Windows Vista (32/64 bit)
- Windows XP (SP3)
- Mac OS X Leopard 10.5 or newer

### Main features

- Hardware-based 2048-bit RSA key encryption. 4096 bit RSA SoftKeys
- TLS Data Encryption, Blowfish-128-CBC, AES-128-CBC, AES-256-CBC
- Layer2/Layer3 VPN Types (OpenVPN)
- Two-factor authentication support
- Dimensions: 74.8 x 23.2 x 10.3 mm (L x W x H)
- Weight: 25 g
- Case: metallic
- Operating temperature: -0°C, ..., +70°C
- Storage temperature: -20°C, ..., +85°C

### Order information

Code	Composition	Package
EK-DEL-TBK1	Key with Tosibox® Cryptographic microcontroller Key that makes 1 PC client + 1 mobile client	
EK-DEL-TBSK1	Tosibox® SoftKey software key to be combined with a key, with Sub Key function	
EK-DEL-TBMC1	Additional license for Tosibox® Key with 1 mobile client	1 pcs.
EK-DEL-TBMC5	Additional license for Tosibox® Key with 5 mobile clients	
EK-DEL-TBMC10	Additional license for Tosibox® Key with 10 mobile clients	



## Rockers for pushbuttons

### 20venti series

WALL-MOUNT DEVICES

### Description

Rockers for use as operation surface for pushbuttons of 20venti series. Rockers are available in several colour and material variations and are passive components.

### Versions

- rectangular with 30 x 15 mm modularity
- square with 15 x 15 mm modularity

### Main features

- In plastic material
- Snap-on mounting
- Customizable with symbols and text backlit by RGB LED

### Order information

Code	Modularity * L x H [mm]	For use with **	Package
EK-T4R-20-BT...	rectangular 30 x 15 symbol/text backlit RGB	pushbutton 20venti series	4 pcs.

\*) The modularity indicated also takes into account the distance between the rockers and between rockers and light-guides and, therefore, differs slightly from the actual size of the single rockers



### Dimensions [mm]

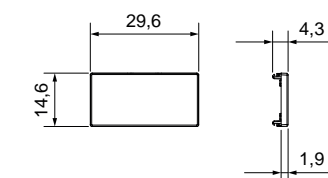

## Rockers for 4-fold pushbuttons - FF series

WALL-MOUNT DEVICES

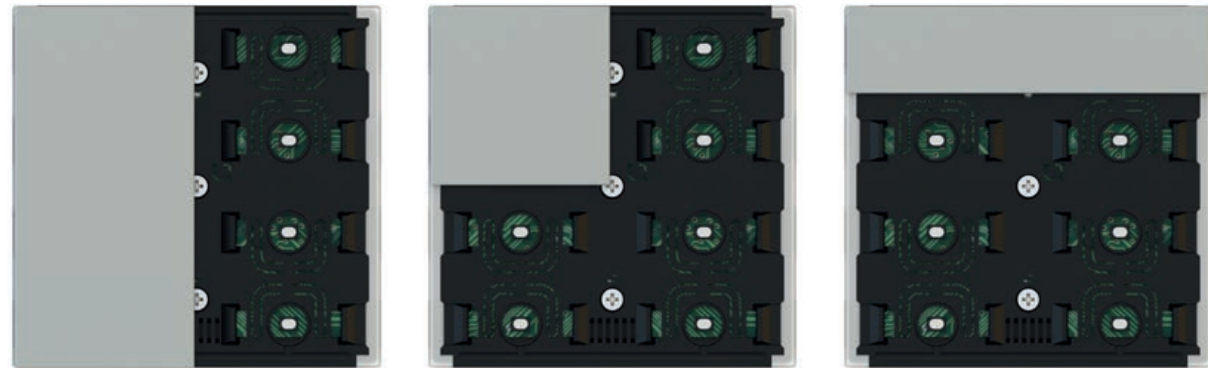

### Description

Rockers for use as operation surface for 4-fold pushbuttons of FF series. They can perform two independent functions by acting on either its upper or lower zones (square and vertical rectangular versions) or on either its left or right zones (horizontal rectangular versions). Rockers are available in several colour and material variations and are passive components.

### Versions

- square with 40 x 40 mm modularity
- horizontal rectangular with 80 x 20 mm modularity
- vertical rectangular with 40 x 80 mm modularity

### Main features

- In plastic material, aluminium or Fenix NTM®
- Snap-on mounting
- Customizable with symbols and text

### Products included

Delivery includes a tool for rockers removal.

### Order

Base-codes must be completed by adding extensions for material, colour and finishing (3 characters) plus symbols and text (3 characters).

### Dimensions [mm]

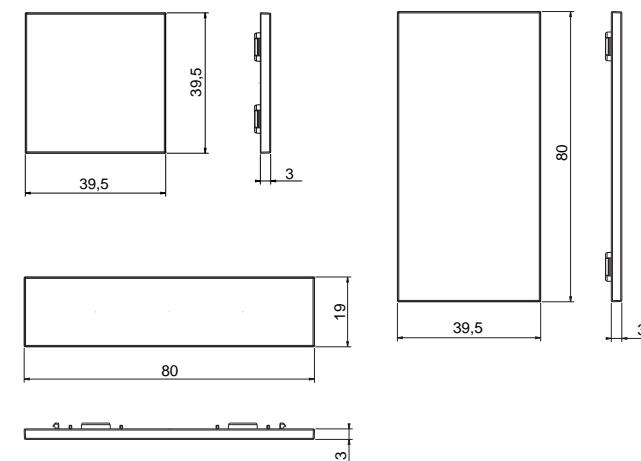

### Order information

Code	Modularity * L x H [mm]	For use with **	Package
EK-TQQ-...	square 40 x 40		4 pcs.
EK-TRV-...	vertical rectangular 40 x 80	4-fold pushbutton FF series	2 pcs.
EK-TRO-...	horizontal rectangular 80 x 20		4 pcs.

\*) The modularity indicated also takes into account the distance between the rockers and between rockers and light guides and, therefore, differs slightly from the actual size of the single rockers  
 \*\*) The actual functioning as pushbutton with 2 or 4 channels depends on the configuration of the device parameters carried out with ETS

Also available in multiple pack of 6 pcs.



## Rockers for 6-fold pushbuttons and Touch&See - FF series

WALL-MOUNT DEVICES

### Description

Rockers for use as operation surface for 6-fold pushbuttons and Touch&See with 2-fold pushbutton of FF series. They can perform two independent functions by pressing on either its upper or lower zones. Rockers are available in several colour and material variations and are passive components.

### Versions

- square with 40 x 40 mm modularity

### Main features

- In plastic material, aluminium or Fenix NTM®
- Snap-on mounting
- Customizable with symbols and text

### Order information

Code	Modularity [mm]	For use with	Package
EK-TQQ-...	square 40 x 40	6-fold pushbutton of FF series Touch&See of FF series	4 pcs.

Also available in multiple pack of 6 pcs.



### Products included

Delivery includes a tool for rockers removal.

### Order

Base-codes must be completed by adding extensions for material, colour and finishing (3 characters) plus symbols and text (3 characters).

### Dimensions [mm]

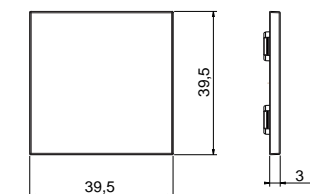





## Set 2 rockers for room thermostats - FF series

WALL-MOUNT DEVICES

### Description

Set rockers for use as operation surface for room thermostats of FF series. They can perform two independent functions by acting on either its upper or lower zones. Rockers are available in several colour and material variations and are passive components.

### Versions

- square with 40 x 40 mm modularity

### Main features

- In plastic material, aluminium or Fenix NTM®
- Snap-on mounting
- Customized with symbols for room thermostat functions

### Order information

Code	Modularity [mm]	For use with	Package.
EK-TQQ-...-EP2	square 40 x 40	room thermostats of FF series	2 pcs.



### Products included

Delivery includes a tool for rockers removal.

### Order

Base-codes must be completed by adding extensions for material, colour and finishing (3 characters).

### Dimensions [mm]

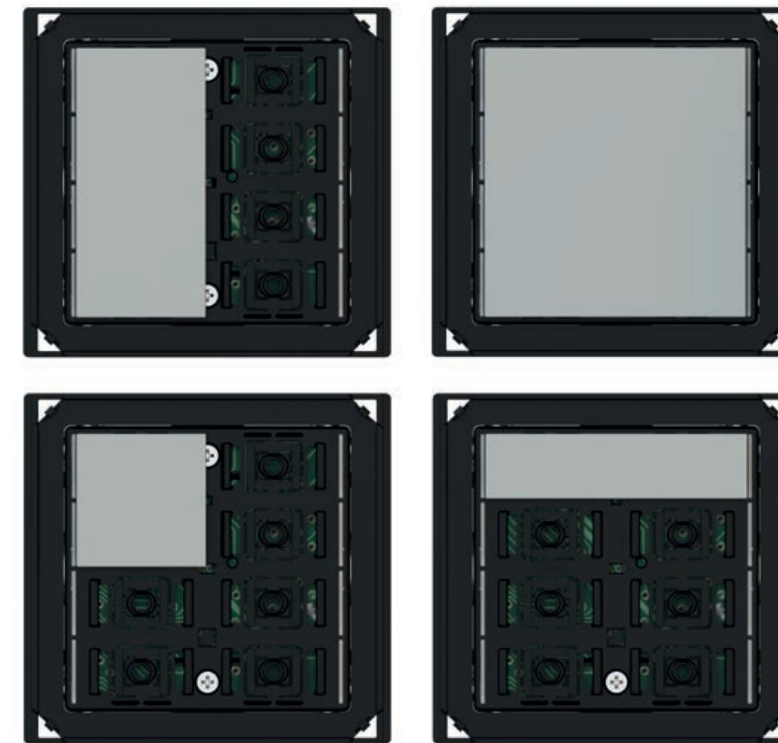
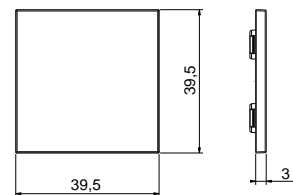

## Rockers for 4-fold pushbuttons - 71 series

WALL-MOUNT DEVICES

### Description

Rockers for use as operation surface for pushbuttons of 71 series. They can perform two independent functions by acting on either its upper or lower zones (square and vertical rectangular versions) or on either its left or right zones (horizontal rectangular versions). Rockers are available in several colour and material variations and are passive components.

### Versions

- square with 60 x 60 mm or 30 x 30 mm modularity
- rectangular with 30 x 60 mm or 60 x 15 mm modularity

### Main features

- In plastic material, aluminium or Fenix NTM®
- Snap-on mounting
- Customizable with symbols and text

### Order information

Code	Modularity * L x H [mm]	For use with **	Package
EK-T1Q-...	square 60 x 60	pushbuttons of 71 series	1 pcs.
EK-T2R-...	vertical rectangular 30 x 60		2 pcs.
EK-T4Q-...	square 30 x 30		4 pcs.
EK-T4R-...	horizontal rectangular 60 x 15		4 pcs.

\*) The modularity indicated also takes into account the distance between the rockers and between rockers and light-guides and, therefore, differs slightly from the actual size of the single rockers  
 \*\*) The actual functioning as pushbutton with 1, 2 or 4 channels depends on the configuration of the device parameters carried out with ETS

Also available in multiple pack of 6 pcs.



### Order

Base-codes must be completed by adding extensions for material, colour and finishing (3 characters) plus symbols and text (3 characters).

### Note

Finishing off a 71 series pushbutton with a square rocker with 60 x 60 mm modularity does not allow the use of the integrated brightness sensor.

### Dimensions [mm]

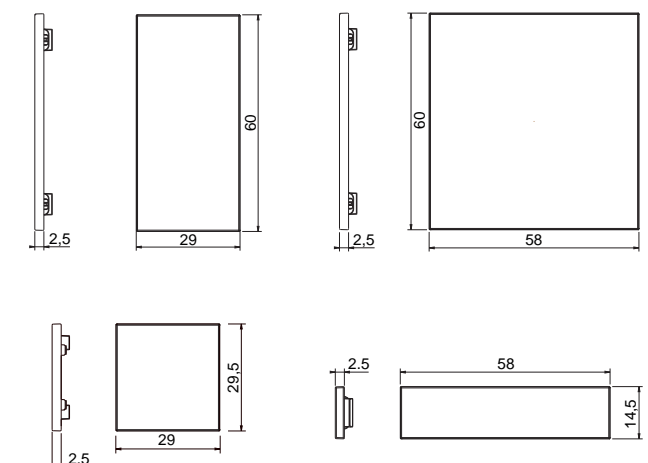



## Full front cover for Multisensor - 71 Series

WALL-MOUNT DEVICES

### Description

Front cover for Multisensor EK-ET2-TP and EK-ES2-TP available in several colour and material variations.

### Versions

- square with 60 x 60 mm modularity

### Main features

- In plastic material, aluminium or Fenix NTM®
- Snap-on mounting

### Order

Base-codes must be completed by adding extensions for material, colour and finishing (3 characters).

### Dimensions [mm]

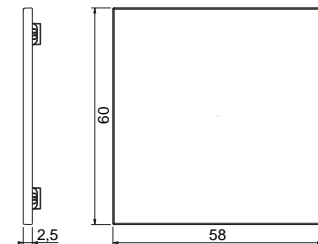

### Order information

Code	Modularity * L x H [mm]	For use with	Package
EK-T1Q-...-ET2	quadrata 60 x 60	Multisensor EK-ET2-TP	1 pcs.
EK-T1Q-...-ES2		Multisensor EK-ES2-TP	

\*) The modularity indicated also takes into account the distance between the front cover and light-guides and, therefore, differs slightly from the actual size of the cover

Also available in multiple pack of 6 pcs.



## Electrical and USB power sockets

WALL-MOUNT DEVICES



Ekinex has paid particular attention to this detail with a special painting process that allows the socket to be colour matched to the other wall elements in its range. The inclusion of a USB output responds to the increasingly pressing need to connect to numerous devices for home or work use.

Essential: this is the most suitable adjective to describe the electrical socket. From the first one invented in America by Hubbel in 1904 to the German-made Schuko dated 1926, the socket has come down to us as the silent player in our electrical systems. Ekinex has given them a new lease of life with a colourful edition that matches keyboards and touch panels. The need to connect to the electricity network has increased in recent years: the list of devices that require a power supply is virtually endless. Ekinex electrical sockets come to your rescue with an extensive range for the Italian and international markets. Ekinex electric sockets are also equipped with USB type A and C ports and can be used to recharge all electronic devices in homes and offices. The many colours are in perfect family feeling with the FF, 71 and 20VENTI series and can be combined with Fenix NTM, metal and plastic finishes.









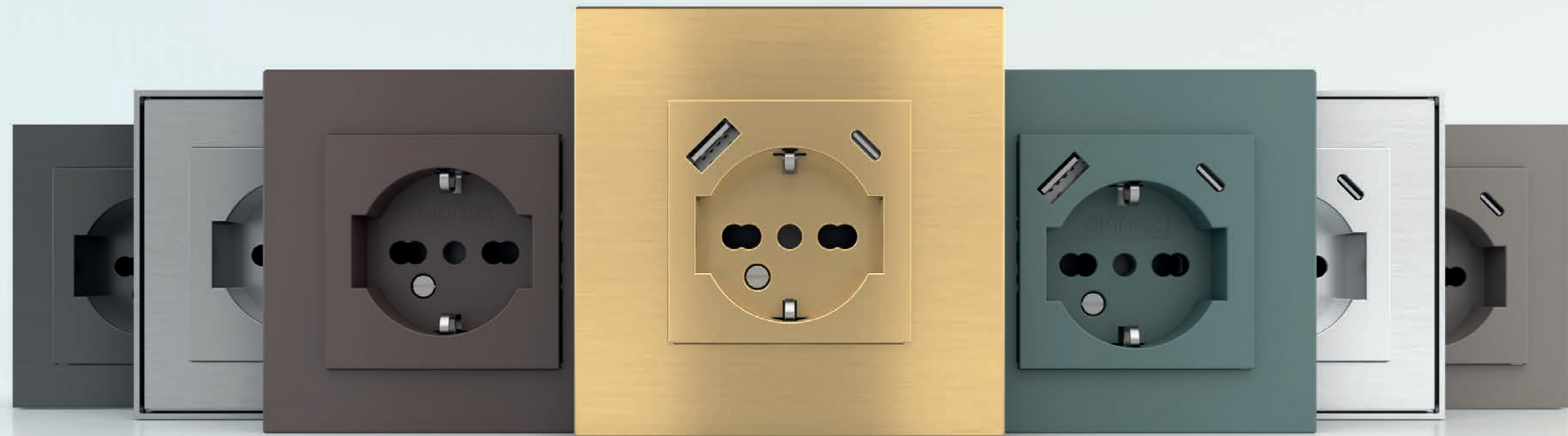

## Italian Version (standard and USB A-C)

WALL-MOUNT DEVICES - POWER SOCKETS

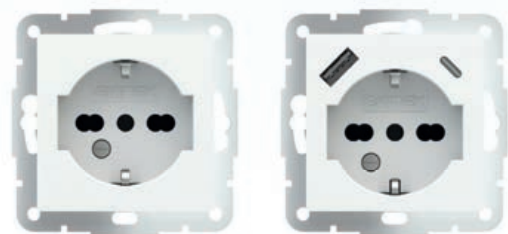

The new Ekinex Italian standard sockets are available in a dual-step version (10-16A) with and without USB, bringing them in line with the latest charging standards with A and C ports and a maximum of 3.5A.

**Available colours**

	Italian Standard	Italian USB A-C
Plastic	•	•
Metal	•	•
Fenix NTM®	•	•

More information on page 161

**FORM  
FLANK  
'NF**



80 x 80 x 8 mm



151 x 80 x 8 mm



151 x 80 x 8 mm

**DEEP**



87 x 87 x 9 mm



158 x 87 x 9 mm



158 x 87 x 9 mm



229 x 87 x 9 mm

**SURFACE**



98 x 98 x 3 mm



168 x 98 x 3 mm



168 x 98 x 3 mm





## Schuko Version (standard and USB A-C)

WALL-MOUNT DEVICES - POWER SOCKETS

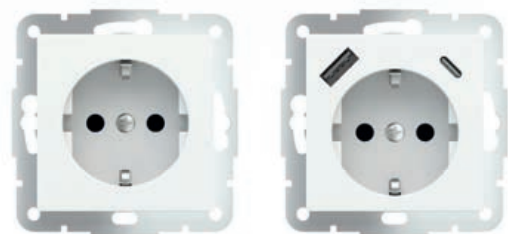

The new Ekinex German standard (Schuko) sockets are available in versions with or without USB, bringing them in line with the latest charging standards with A and C ports and a maximum of 3.5A.

**Available colours**

	Italian Standard	Italian USB A-C
Plastic	•	•
Metal	•	•
Fenix NTM®	•	•

More information on page 161

**FORM  
FLANK  
'NF**



80 x 80 x 8 mm

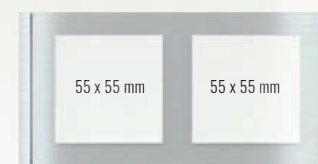

151 x 80 x 8 mm



151 x 80 x 8 mm

**DEEP**



87 x 87 x 9 mm



158 x 87 x 9 mm



158 x 87 x 9 mm



229 x 87 x 9 mm

**SURFACE**



98 x 98 x 3 mm



168 x 98 x 3 mm



168 x 98 x 3 mm

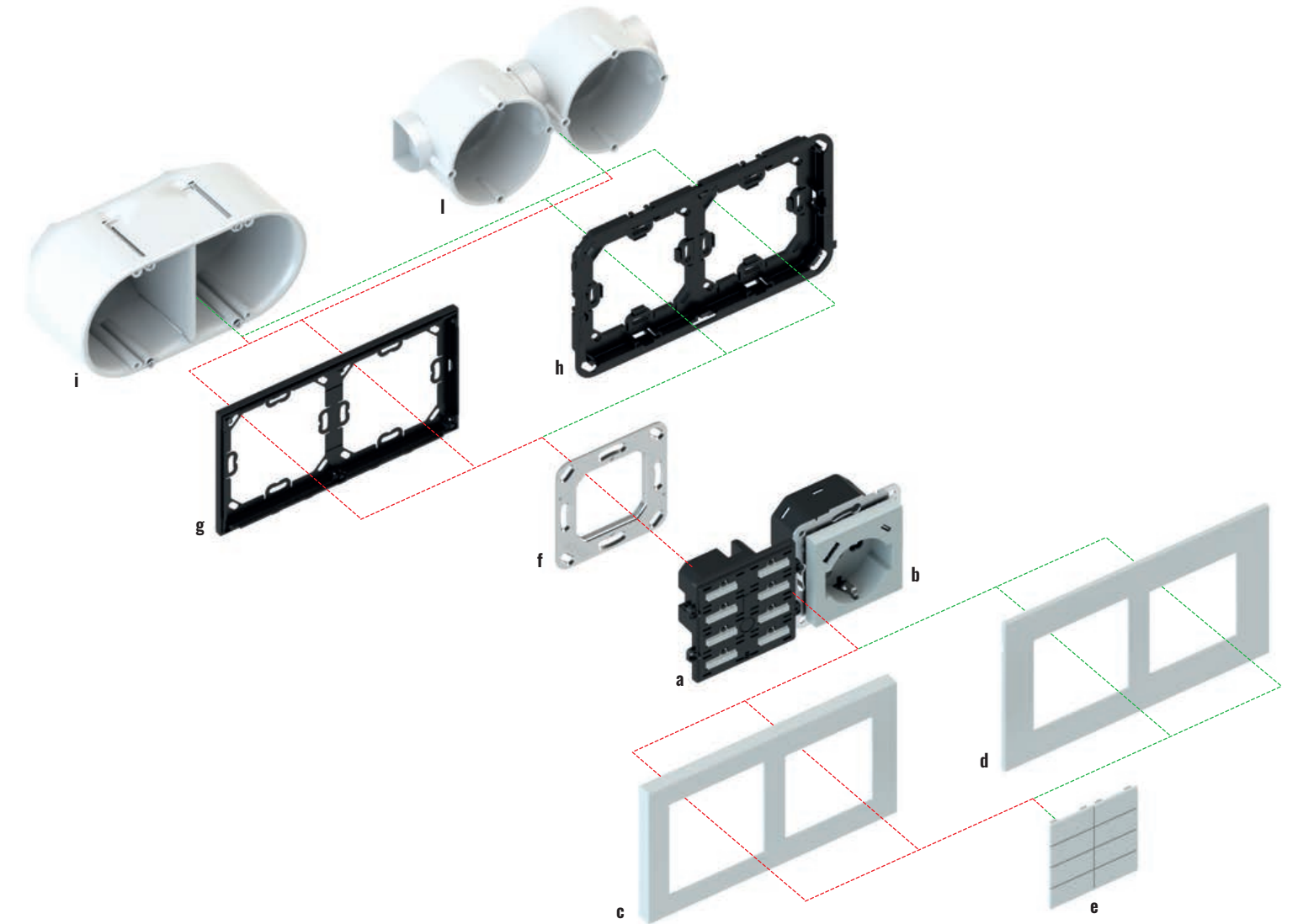
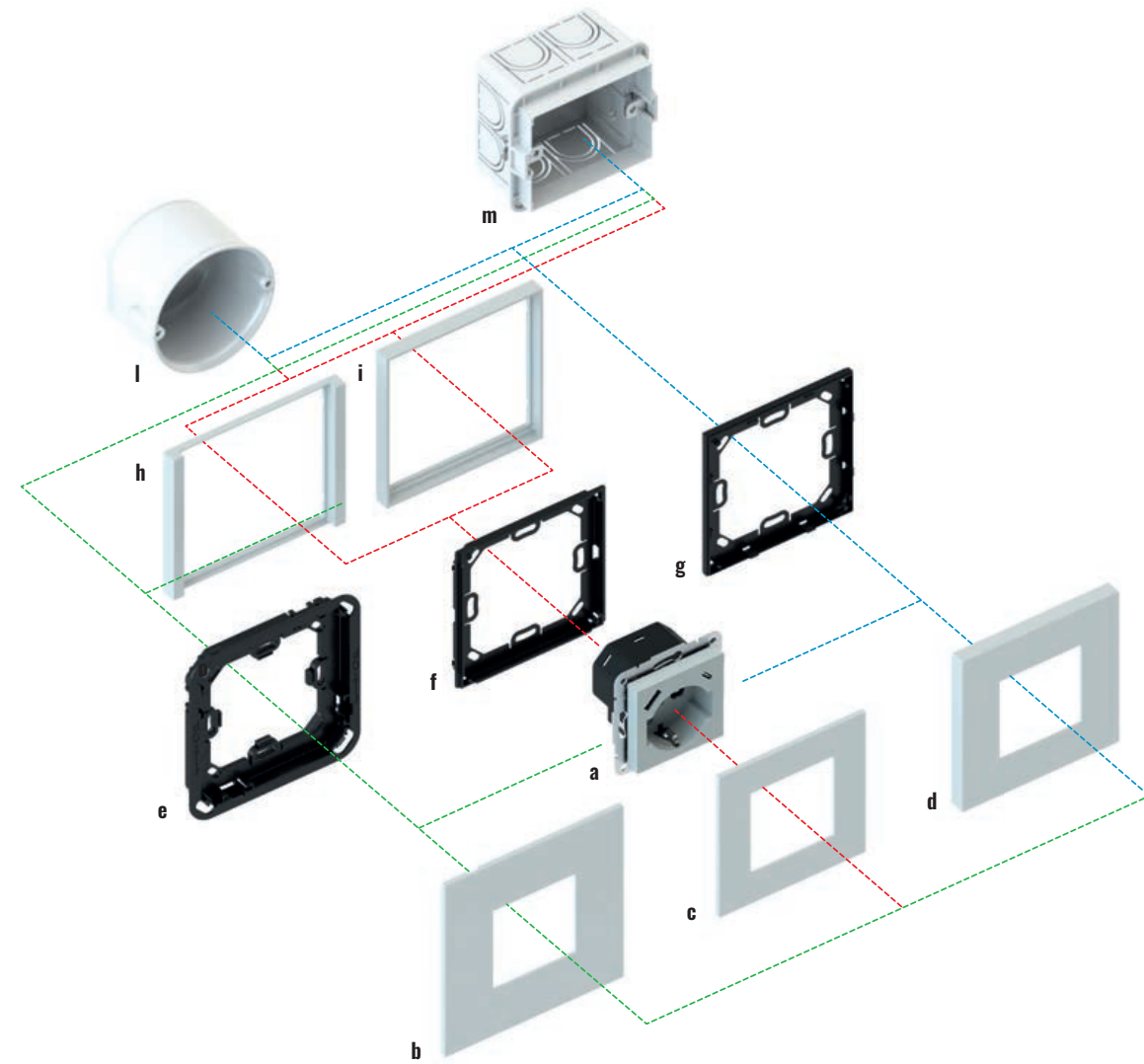

**Completion of power sockets**

Description	Code	Page
	EK-PWS-IT + EK-PSC-IT-...	131
a) Power socket (window 55 x 55 mm)	EK-PWS-IT-USB + EK-PSC-IT-USB...	131
	EK-PWS-DE + EK-PSC-DE-...	132
	EK-PWS-DE-USB + EK-PSC-DE-USB...	132
b) Surface square plate	EK-SQG-...	143
c) Square plate	EK-PQG-...	136
d) Deep square plate	EK-DQG-...	139
e) Adapter for square Surface plate	EK-TAS-Q-...-NF	143

Description	Code	Page
f) Adapter for square plate - Form or Flank frames**	EK-TAQ	136
g) Adapter for square plate 'NF' and Deep series	EK-TAQ-...-NF	136-139
h) Square frame of Flank series	EK-FLQ-...	134
i) Square frame of Form series	EK-FOQ-...	133
l) Round built-in box	not delivered by Ekinex®	-
m) Square built-in box	not delivered by Ekinex®	-

\*\*\*) Including the relevant button series 71

**Double installation with centre distance 71 mm (20vent series)**

Description	Code	Page
a) Pushbutton - 20venti series	EK-E20-TP	30
b) Power socket (window 55 x 55 mm)	EK-PWS-IT + EK-PSC-IT-...	131
	EK-PWS-IT-USB + EK-PSC-IT-USB...	131
	EK-PWS-DE + EK-PSC-DE-...	132
	EK-PWS-DE-USB + EK-PSC-DE-USB...	132
c) Deep double plate - 71 series	EK-D2G-...	141
d) Surface double plate - 71 series	EK-S2G-...	145

Description	Code	Page
e) Horizontal rectangular keys (8)	EK-T4R-20-...	113
f) Metal mounting support	EK-SMQ-71	153
g) Double adapter for frame-free installation	EK-A71-...-NF	141
h) Double adapter for Surface double plate	EK-TAS-D-...	145
i) Double box for mobile walls	not delivered by Ekinex®	-
l) Single boxes for masonry walls	not delivered by Ekinex®	-

\*) Including Form or Flank series double frame



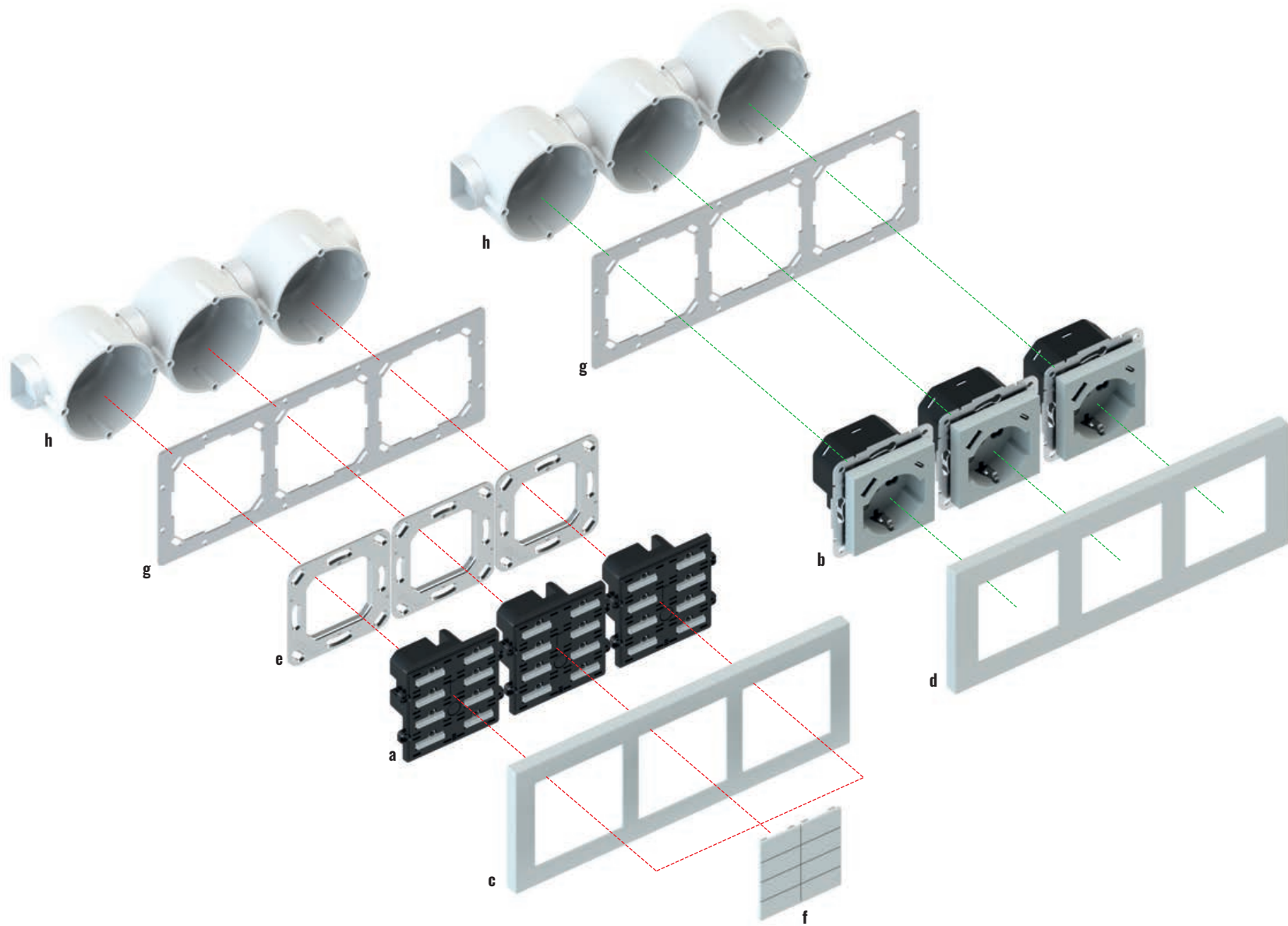

Triple installation with centre distance 71 mm (20vent series)

Description	Code	Page
a) Pushbutton 20venti series	EK-E20-TP	30
	EK-PWS-IT + EK-PSC-IT-...	131
b) Power socket (window 55 x 55 mm)	EK-PWS-IT-USB + EK-PSC-IT-USB...	131
	EK-PWS-DE + EK-PSC-DE-...	132
	EK-PWS-DE-USB + EK-PSC-DE-USB...	132
c) Deep triple plate - 71 series	EK-D3S-...	142

Description	Code	Page
d) Deep triple plate - 71 series	EK-D3P-...	142
e) Metal mounting support	EK-SMQ-71	153
f) Horizontal rectangular keys (8)	EK-T1Q-...	113
g) Triple plate adapter - Deep series*	EK-B71-...-NF	142
h) Single boxes for masonry walls	not delivered by Ekinex®	-
*) Including Deep series triple plate		

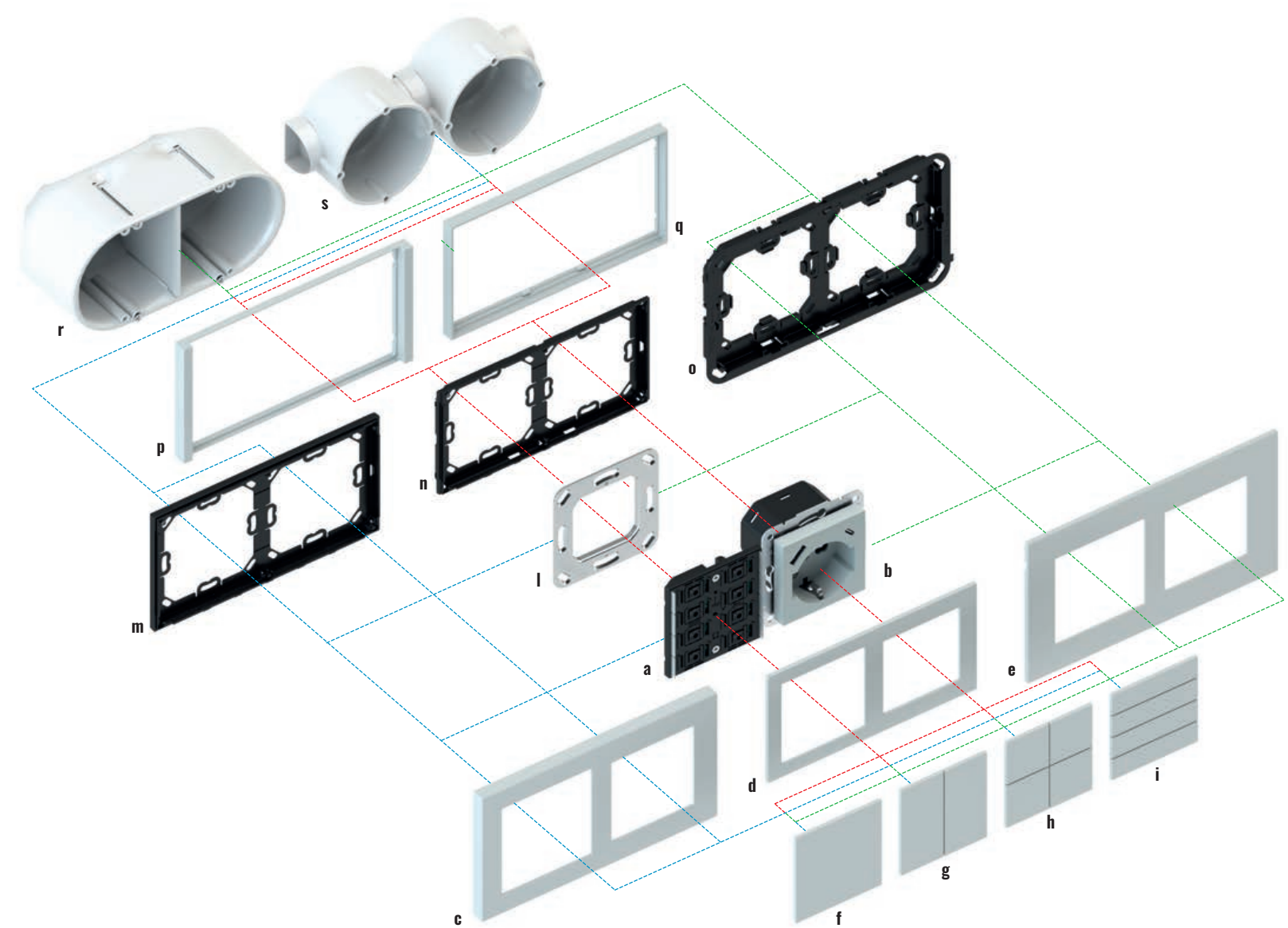

Double installation with centre distance 71 mm (71 series)

Description	Code	Page
a) Pushbutton - 71 series	EK-E12-TP-... o EK-E22-TP-...	90-92
	EK-PWS-IT + EK-PSC-IT-...	131
b) Power socket (window 55 x 55 mm)	EK-PWS-IT-USB + EK-PSC-IT-USB...	131
	EK-PWS-DE + EK-PSC-DE-...	132
	EK-PWS-DE-USB + EK-PSC-DE-USB...	132
c) Deep double plate - 71 series	EK-D2G-...	141
d) Double plate - 71 series	EK-P2G-...	138
e) Surface double plate - 71 series	EK-S2G-...	145
f) Square rocker (1)	EK-T1Q-...	117
g) Rectangular vertical rockers (2)	EK-T2R-...	117
h) Square rockers (4)	EK-T4Q-...	117

Description	Code	Page
i) Rectangular horizontal rockers (4)	EK-T4R-...	117
l) Metal mounting support	EK-SMQ-71	153
m) Double adapter for frame-free installation	EK-A71-...-NF	138
n) Adapter for double plate with a Form or Flank frame*	EK-A71	138
o) Double adapter for Surface double plate	EK-TAS-D-...	145
p) Flank series double frame (with adapter)	EK-FL2-...	135
q) Form series double frame (with adapter)	EK-F02-...	135
r) Double box for mobile walls	not delivered by Ekinex®	-
s) Single boxes for masonry walls	not delivered by Ekinex®	-
*) Including Form or Flank series double frame		

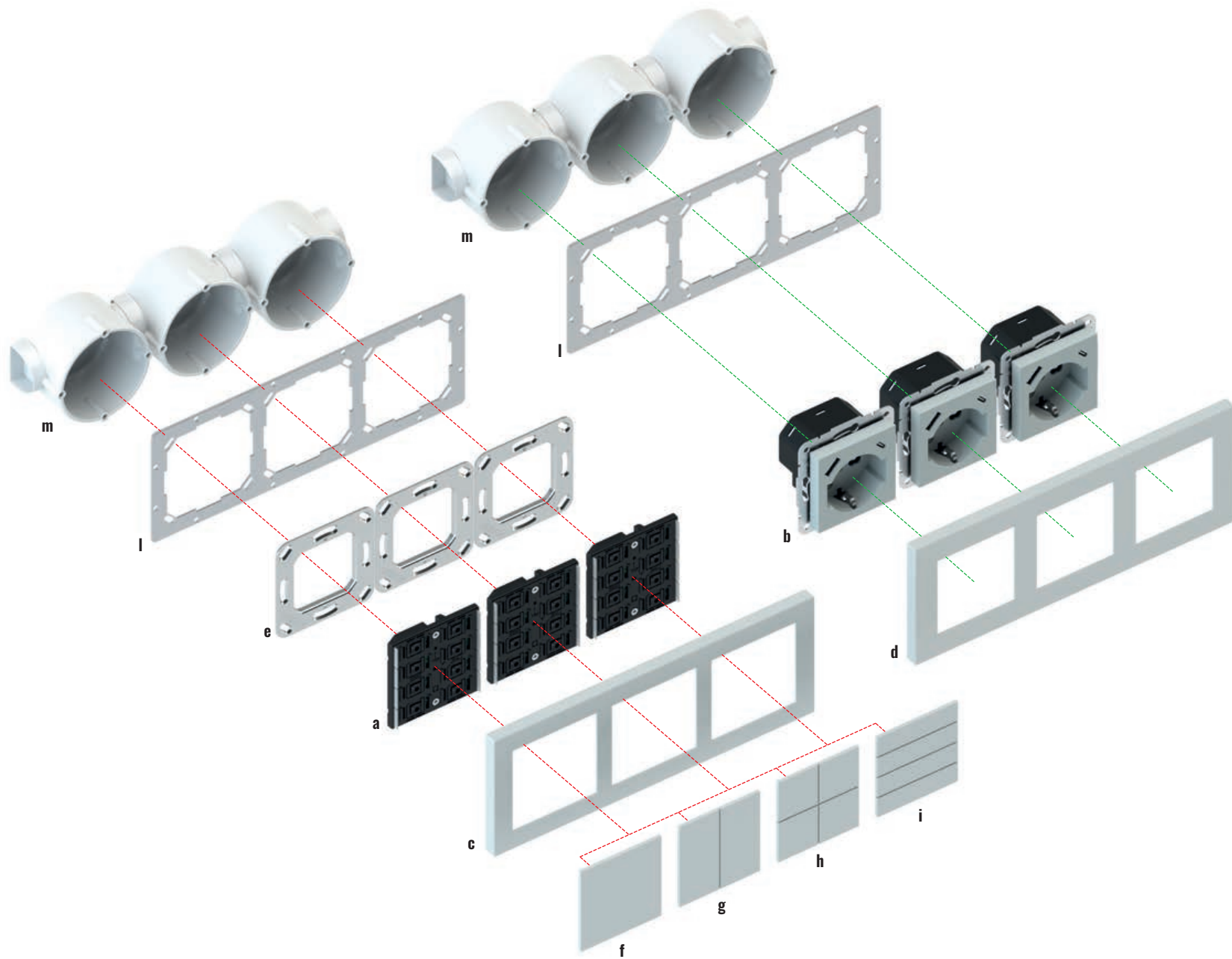

Triple installation with centre distance 71 mm (71 series)

Description	Code	Page
a) Pushbutton - 71 series	EK-E12-TP-... o EK-E22-TP-...	90-92
	EK-PWS-IT + EK-PSC-IT-...	131
	EK-PWS-DE + EK-PSC-DE-...	132
b) Power socket (window 55 x 55 mm)	EK-PWS-IT-USB + EK-PSC-IT-USB...	131
	EK-PWS-DE-USB + EK-PSC-DE-USB...	132
c) Deep triple plate - 71 series	EK-D3S-...	142
d) Deep triple plate - 71 series	EK-D3P-...	142
e) Metal mounting support	EK-SMQ-71	153

Description	Code	Page
f) Square rocker (1)	EK-T1Q-...	117
g) Rectangular vertical rockers (2)	EK-T2R-...	117
h) Square rockers (4)	EK-T4Q-...	117
i) Rectangular horizontal rockers (4)	EK-T4R-...	117
l) Triple plate adapter - Deep series*	EK-B71-...-NF	142
m) Single boxes for masonry walls	not delivered by Ekinex®	-

\*) Including Deep series triple plate

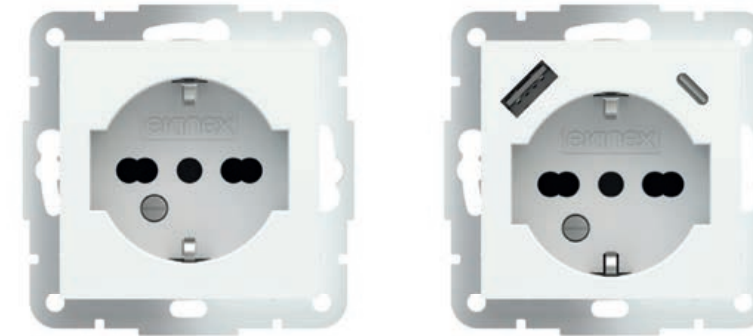

## Power socket and USB A-C Italian version

WALL-MOUNT DEVICES - POWER SOCKETS

### Description

The ekinex model EK-PWS-IT-USB and EK-PWS-IT universal italian standard sockets are 2P+T 16 A universal type devices for wall installation, for 2P 2.5 A europlugs, 2P and 2P + E 10 A and 16 A Italian standard plugs, 2P+T 16 A German standard plugs, for powering household appliances. The EK-PWS-IT-USB model is equipped with a USB power unit, both type-A and type-C, for charging mobile phones and in general all electronic devices that can be recharged via USB sockets of the same type. Charging of two devices at the same time is allowed.

### Main characteristics

- Connection of home devices with AC 250 V ~ voltage
- Contacts protected by shutters
- Mounting on a round or square wall box
- Terminals for cables with section up to 2.5 mm<sup>2</sup>
- USB Type-A and Type-C ports for charging electronic devices such as smartphones, tablets, etc. (only for EK-PWS-EN-EN-USB) (only for EK-PWS-IT-USB)

### Technical data

- Max. rated input voltage: AC 250 V ~
- Max rated input current: 16 A
- Network frequency: 50/60 Hz
- USB output voltage (only for EK-PWS-IT-USB): DC 5 V
- USB output current (only for EK-PWS-IT-USB): 3.4 A
- Standby power (only for EK-PWS-IT-USB): < 50mW
- Energy efficiency (only for EK-PWS-IT-USB): 83%
- Operating temperature: -10 ... +40 ° C (indoor use)
- Storage / transport temperature: -20 ... +50 ° C
- Protection degree : IP 20
- Safety class 2 (double insulation)
- Connection type: solid or stranded cable with 1.5 ... 2.5 mm<sup>2</sup> section
- Connection type: screw
- Mounting depth: min. 40 mm
- Housing in plastic material
- Dimensions: 70 x 70 x 44 mm (LxHxP)

### Order information

Code	Type	Code	Type
EK-PWS-IT	power socket - italian	EK-PWS-IT-USB	power socket - italian USB
EK-PSC-IT	rough white cover	EK-PSC-IT-USB	rough white cover
EK-PSC-IT-...	painted cover	EK-PSC-IT-USB-...	painted cover

### Delivery

Plastic adapters, plates and frames are available for mounting on round or square flush-mounted boxes with fixing holes 60 mm apart, or on combinable round flush-mounted boxes with 71 mm center-to-center distance.

### Accessories

The following accessories are available for completion and must be ordered separately:

- Form series square and double frame or Flank
- Square, double and triple plate with 55 x 55 mm window

### Dimensions [mm]

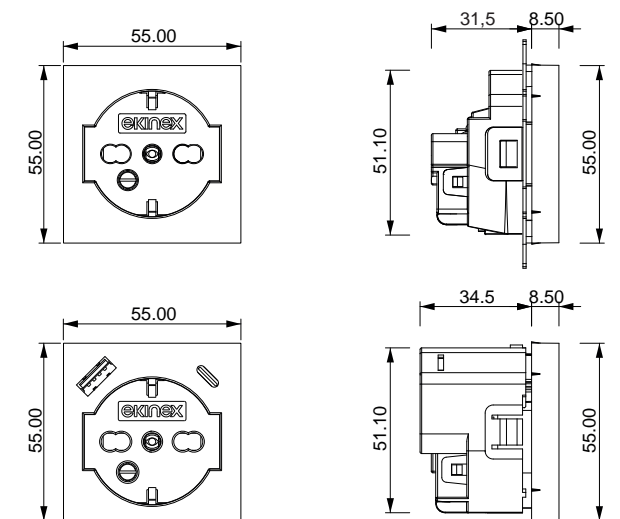

### Documentation

For more information see the instruction sheet FISPPWSITIEXX00\_P.pdf, download from [www.ekinex.com](http://www.ekinex.com)





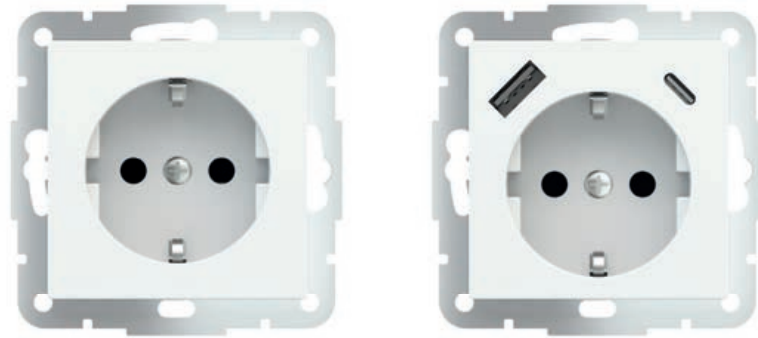

## Power socket and USB A-C Schuko version

WALL-MOUNT DEVICES - POWER SOCKETS

### Description

The ekinex model EK-PWS-DE-USB and EK-PWS-DE Schuko® sockets (German standard) are 2P + T 16 A type wall installation devices, for powering household appliances. The EK-PWS-DE-USB model is equipped with a USB power unit, both type-A and type-C, for charging mobile phones and in general all electronic devices that can be recharged via USB sockets of the same type. Charging of two devices at the same time is allowed.

### Main characteristics

- Connection of home devices with AC 250 V ~ voltage
- Contacts protected by shutters
- Mounting on a round or square wall box
- Terminals for cables with section up to 2.5 mm<sup>2</sup>
- USB Type-A and Type-C ports for charging electronic devices such as smartphones, tablets, etc. (only for EK-PWS-DE-USB)

### Technical data

- Max. rated input voltage: AC 250 V ~
- Max rated input current: 16 A
- Network frequency: 50/60 Hz
- USB output voltage (only for EK-PWS-DE-USB): DC 5 V
- USB output current (only for EK-PWS-DE-USB): 3.4 A
- Standby power (only for EK-PWS-DE-USB): ≤ 50mW
- Energy efficiency (only for EK-PWS-DE-USB): 83%
- Operating temperature: -10 ... +40 ° C (indoor use)
- Storage / transport temperature: -20 ... +50 ° C
- Protection degree : IP 20
- Safety class 2 (double insulation)
- Connection type: solid or stranded cable with 1.5 ... 2.5 mm<sup>2</sup> section
- Connection type: screw
- Mounting depth: min. 40 mm
- Housing in plastic material
- Dimensions: 70 x 70 x 44 mm (LxHxP)

### Delivery

Plastic adapters, plates and frames are available for mounting on round or square flush-mounted boxes with fixing holes 60 mm apart, or on combinable round flush-mounted boxes with 71 mm center-to-center distance.

### Accessories

The following accessories are available for completion and must be ordered separately:

- Form series square and double frame or Flank
- Square, double and triple plate with 55 x 55 mm window

### Dimensions [mm]

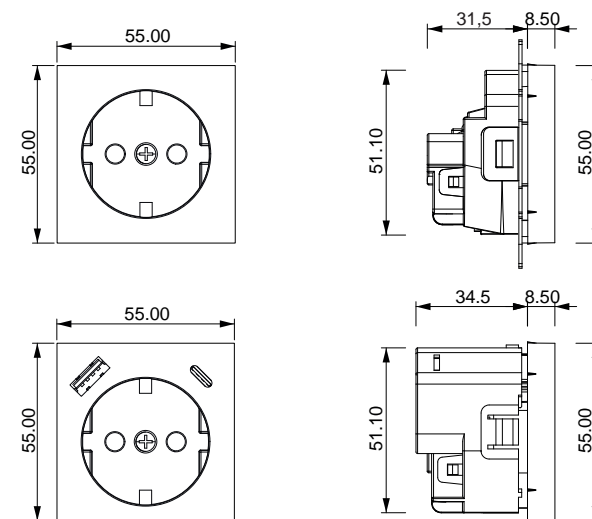

### Documentation

For more information see the instruction sheet **FISPPWSDEIEXX00\_P.pdf**, download from [www.ekinex.com](http://www.ekinex.com)

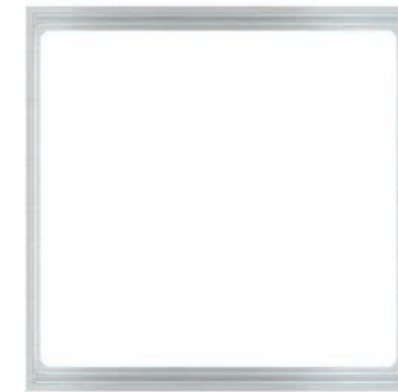

### Description

Square frame of Form series for finishing Ekinex® devices of FF and 71 series. Available in several colours and materials.

### Main characteristics

- In plastic material or aluminium or Fenix NTM®
- Snap-on mounting

### Order information

Code	Dimensions L x H x P [mm]	For use with	Package
EK-FOQ-...	86 x 86 x 8	devices of FF and 71 series	1 pcs.

Also available in multiple pack of 6 pcs.



### Description

Rectangular frame of Form series for finishing Ekinex® devices of FF and 71 series. Available in several colours and materials.

### Main characteristics

- In plastic material or aluminium or Fenix NTM®
- Snap-on mounting

### Order information

Code	Dimensions L x H x P [mm]	For use with	Package
EK-FOR-...	126 x 86 x 8	devices of FF and 71 series	1 pcs.

Also available in multiple pack of 6 pcs.

## Square frame - Form series

WALL-MOUNT DEVICES

### Order

Base-codes (EK-FOQ) must be completed by adding extensions for material, colour and finishing (3 characters).

### Dimensions [mm]

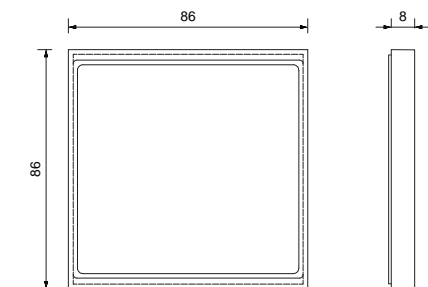

## Rectangular frame - Form series

WALL-MOUNT DEVICES

### Order

Base-codes (EK-FOR) must be completed by adding extensions for material, colour and finishing (3 characters).

### Dimensions [mm]

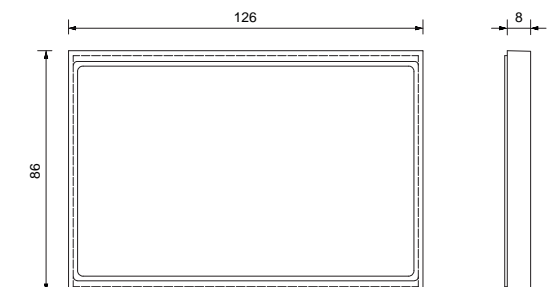



## Square frame - Flank series

WALL-MOUNT DEVICES

### Description

Square frame of Flank series for finishing Ekinex® devices of FF and 71 series. Available in several colours and materials.

### Main characteristics

- In plastic material or aluminium
- Snap-on mounting

### Order information

Code	Dimensions L x H x P [mm]	For use with	Package
EK-FLQ-...	94 x 80 x 8	devices of FF and 71 series	1 pcs.

Also available in multiple pack of 6 pcs.

### Order

Base-codes (EK-FLQ) must be completed by adding extensions for material, colour and finishing (3 characters).

### Dimensions [mm]

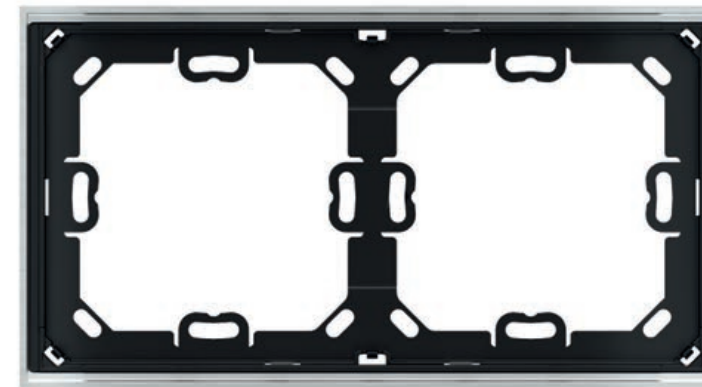
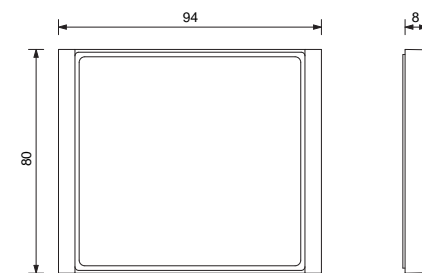

## Double frame - Form series

WALL-MOUNT DEVICES

### Description

Double frame of Form series for finishing Ekinex® devices of 71 series. Available in several colours and materials.

### Main characteristics

- In plastic material or aluminium or Fenix NTM®

### Delivery

Delivery includes a plastic adapter.

### Order information

Code	Dimensions L x H x P [mm]	For use with	Package
EK-F02-...	157 x 86 x 8	devices of 71 series	1 pcs.

### Order

Base-codes (EK-F02) must be completed by adding extensions for material, colour and finishing (3 characters).

### Dimensions [mm]

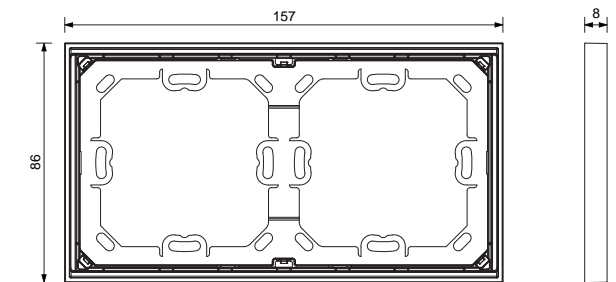

## Rectangular frame - Flank series

WALL-MOUNT DEVICES

### Description

Rectangular frame of Flank series for finishing Ekinex® devices of FF and 71 series. Available in several colours and materials.

### Main characteristics

- In plastic material or aluminium
- Snap-on mounting

### Order information

Code	Dimensions L x H x P [mm]	For use with	Package
EK-FLR-...	135 x 80 x 8	devices of FF and 71 series	1 pcs.

Also available in multiple pack of 6 pcs.

### Order

Base-codes (EK-FLR) must be completed by adding extensions for material, colour and finishing (3 characters).

### Dimensions [mm]

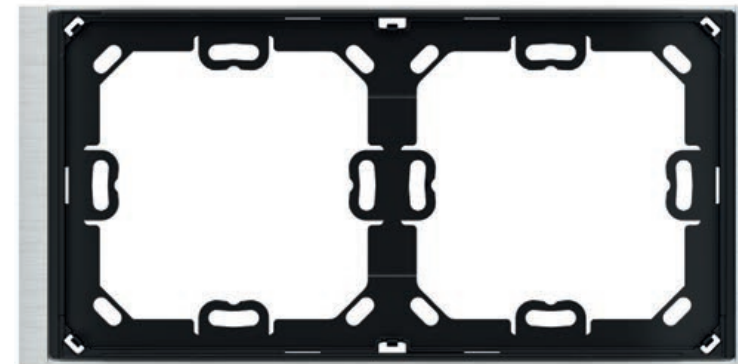
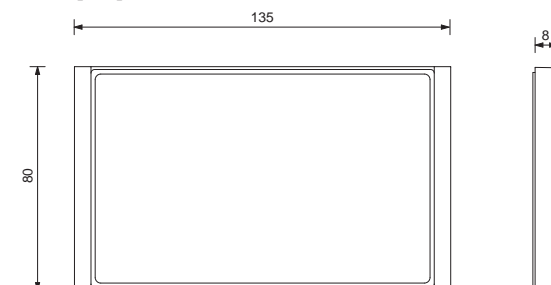

## Double frame - Flank series

WALL-MOUNT DEVICES

### Description

Double frame of Flank series for finishing Ekinex® devices of 71 series. Available in several colours and materials.

### Main characteristics

- In plastic material or aluminium

### Order information

Code	Dimensions L x H x P [mm]	For use with	Package
EK-FL2-...	165 x 80 x 8	devices of 71 series	1 pcs.

### Delivery

Delivery includes a plastic adapter.

### Order

Base-codes (EK-FL2) must be completed by adding extensions for material, colour and finishing (3 characters).

### Dimensions [mm]

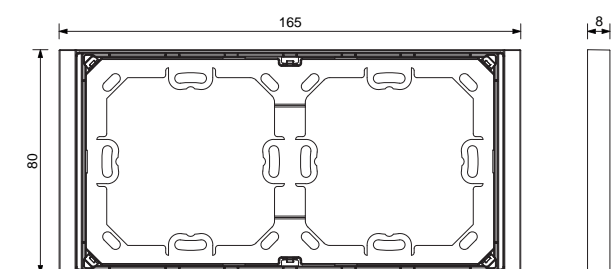





## Square plate

WALL-MOUNT DEVICES

### Description

Square plate for finishing Ekinex® devices of 71 series or market-standard flush-mounted inserts. Available in several colours and materials. To be used in combination with a square frame of the Form or Flank series. The plate can be also mounted without frame in combination with an adapter of the 'NF series.

### Main characteristics

- In plastic material or aluminium or Fenix NTM®
- Central window in three dimensions
- Snap-on mounting

### Order information

Code	Window L x H [mm]	For use with*	Package
EK-PQP-...	45 x 45	standard flush-mounted inserts	1 pcs.
EK-PQG-...	55 x 55		
EK-PQS-...	60 x 60	devices of 71 series	

\*) In case of mounting without frame is used an adapter for 'NF series (to be ordered separately)

Also available in multiple pack of 6 pcs.

### Delivery

Delivery of each square plate includes an adapter (EK-TAQ) for mounting with a Form or Flank frame.

### Order

Base-codes must be completed by adding extensions for material, colour and finishing (3 characters).

### Dimensions [mm]

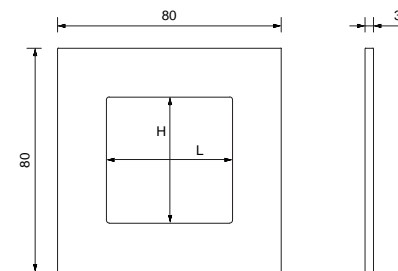

## Adapter for square plate

WALL-MOUNT DEVICES

### Order information

Code	For use with	Side profile	Package
EK-TAQ	square plate with a Form or Flank frame	-	10 pcs.
EK-TAQ-1-NF	square plate without frame ('NF series)	black	1 pcs.
EK-TAQ-1-NFW		white	
EK-TAQ-5-NF		black	5 pcs.
EK-TAQ-5-NFW	white		

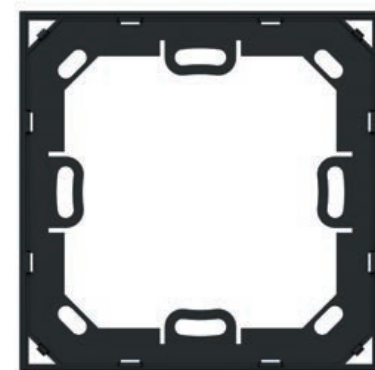

### Description

Adapter for snap-on mounting of a square plate.

### Main characteristics

- Plastic material
- Side profile in black or white colour (only 'NF version)
- Mounting onto round or square mounting box with fixing holes 60 mm apart



## Rectangular plate

WALL-MOUNT DEVICES

### Description

Rectangular plate for finishing market-standard flush-mounted inserts. Available in several colours and materials. To be used in combination with a rectangular frame of the Form or Flank series. The plate can be also mounted without frame in combination with an adapter of the 'NF series.

### Main characteristics

- In plastic material or aluminium or Fenix NTM®
- Central window in three dimensions
- Snap-on mounting

### Order information

Code	Window L x H [mm]	For use with*	Package
EK-PRP-... **	66 x 44	standard flush-mounted inserts	1 pcs.
EK-PRG-...	68 x 45		
EK-PRS	60 x 60	devices of 71 series	

\*) In case of mounting without frame is used an adapter for 'NF series (to be ordered separately)  
\*\*) Available only in Fenix NTM®

Also available in multiple pack of 6 pcs.

### Delivery

Delivery of each rectangular plate includes an adapter (EK-TAR) for mounting with a Form or Flank frame.

### Order

Base-codes must be completed by adding extensions for material, colour and finishing (3 characters).

### Dimensions [mm]

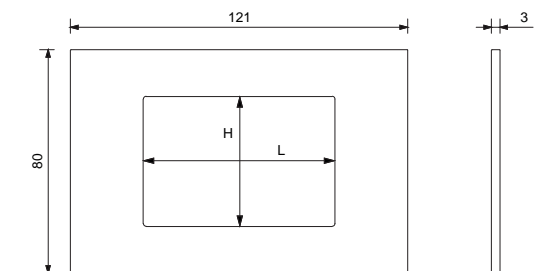

## Adapter for rectangular plate

WALL-MOUNT DEVICES

### Order information

Code	For use with	Side profile	Package
EK-TAR	rectangular plate and Form or Flank frame	-	10 pcs.
EK-TAR-1-NF	rectangular plate without frame ('NF series)	black	1 pcs.
EK-TAR-1-NFW		white	
EK-TAR-5-NF		black	5 pcs.
EK-TAR-5-NFW	white		

### Description

Adapter for snap-on mounting of a rectangular plate.

### Main characteristics

- Plastic material
- Side profile in black or white colour (only 'NF version)
- Mounting onto round or square mounting box with fixing holes 60 mm apart or onto rectangular mounting box with fixing holes 83,5 mm apart



## Double plate

WALL-MOUNT DEVICES

### Description

Double plate for finishing standard flush-mounting inserts and/or Ekinex® devices of 71 series. Available in several colours and materials. To be used in combination with a double frame of the Form or Flank series. The plate can be also mounted without frame in combination with an adapter of the 'NF' series.

### Main characteristics

- In plastic material or aluminium or Fenix NTM®
- 3 combinations of windows sizes
- Snap-on mounting

### Order information

Code	Windows L x H [mm]	For use with*	Package
EK-P2E-...**	45 x 45 (2)	two devices installed 71 mm apart (bus devices of 71 series and/or flush-mounting inserts)	1 pcs.
EK-P2F-...**	45 x 45 (1), 60 x 60 (1)		
EK-P2P-...	55 x 55 (2)		
EK-P2G-...	55 x 55 (1), 60 x 60 (1)		
EK-P2S-...	60 x 60 (2)		

\*) In case of mounting without frame is used an adapter for 'NF' series (to be ordered separately)  
 \*\*) Not available in plastic

### Order

Base-codes must be completed by adding extensions for material, colour and finishing (3 characters).

### Note

The adapter (EK-A71) for mounting with double frame of Form or Flank series is included in the delivery of the frame.

### Dimensions [mm]

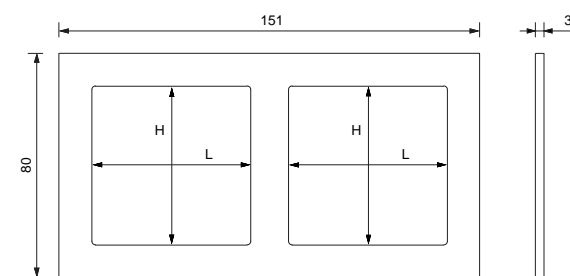

## Deep square plate

WALL-MOUNT DEVICES

### Description

Deep Series square plate for finishing Ekinex® devices of 20venti and 71 series or market-standard flush-mounted inserts. Available in several colours and materials.

### Main characteristics

- For use on round mounting box with fixing holes 60 mm apart
- In plastic material (not available for EK-DQT-...) or aluminium or Fenix NTM®
- Central window in four dimensions
- Snap-on mounting on adapter

### Order information

Code	Window L x H [mm]	For use with	Package
EK-DQP-...	45 x 45	standard flush-mounted inserts	1 pcs.
EK-DQG-...	55 x 55	standard flush-mounted inserts	
EK-DQT-...	30 x 60	devices of 20venti series (4 rockers)	
EK-DQS-...	60 x 60	devices of 20venti and 71 series	

### Delivery

Delivery of each Deep square plate includes an adapter (EK-TAQ-1-NF).

### Order

Base-codes must be completed by adding extensions for material, colour and finishing (3 characters).

### Dimensions [mm]

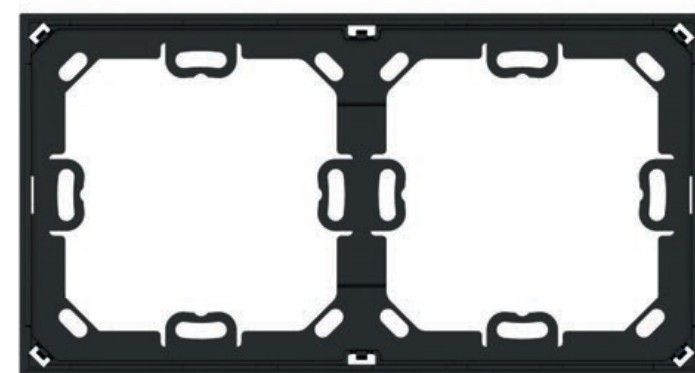
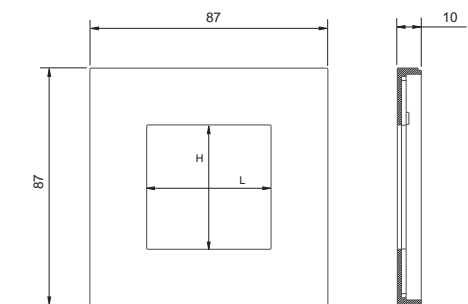

## Adapter for double plate

WALL-MOUNT DEVICES

### Description

Adapter for snap-on mounting of a double plate.

### Main characteristics

- In plastic material
- Side profile in black or white colour
- For mounting onto round modular flush-mounting boxes (71 mm apart)

### Order information

Code	For use with	Side profile	Package
EK-A71	double plate with a Form or Flank frame	-	10 pcs.
EK-A71-1-NF	double plate of 71 series without frame ('NF' series)	black	1 pcs.
EK-A71-1-NFW		white	
EK-A71-5-NF		black	5 pcs.
EK-A71-5-NFW		white	

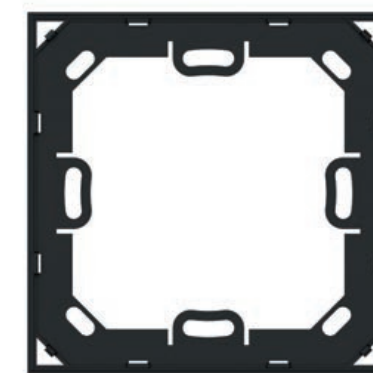

## Adapter for Deep square plate

WALL-MOUNT DEVICES

### Description

Adapter for snap-on mounting of a Deep square plate.

### Main characteristics

- Plastic material
- Side profile in black colour
- Mounting onto round or square mounting box with fixing holes 60 mm apart

### Order information

Code	For use with	Side profile	Package
EK-TAQ-1-NF	Deep square plate	black	1 pcs.
EK-TAQ-5-NF			5 pcs.



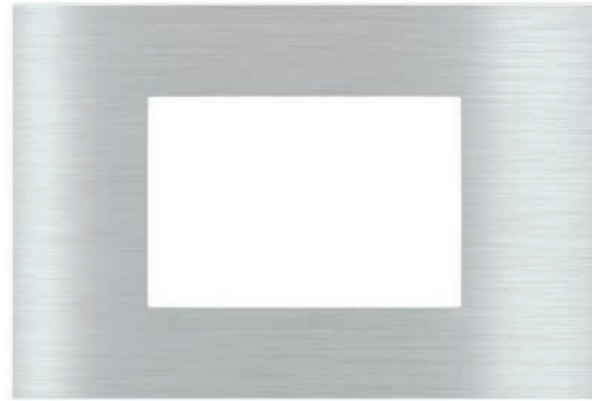

## Deep rectangular plate

WALL-MOUNT DEVICES

### Description

Deep Series rectangular plate for finishing Ekinex® devices of 20venti and 71 series or market-standard flush-mounted inserts. Available in several colours and materials.

### Main characteristics

- Mounting onto rectangular 3 seater mounting box according to the Italian installation standard provided with fixing holes 83,5 mm apart
- In plastic material or aluminium or Fenix NTM®
- Central window in two dimensions
- Snap-on mounting on adapter

### Order information

Code	Window L x H [mm]	For use with	Package
EK-DRG-...	68 x 45	standard flush-mounted inserts	1 pcs.
EK-DRS-...	60 x 60	devices of 20venti and 71 series	

### Delivery

Delivery of each Deep rectangular plate includes an adapter (EK-TAR-1-NF).

### Order

Base-codes must be completed by adding extensions for material, colour and finishing (3 characters).

### Dimensions [mm]

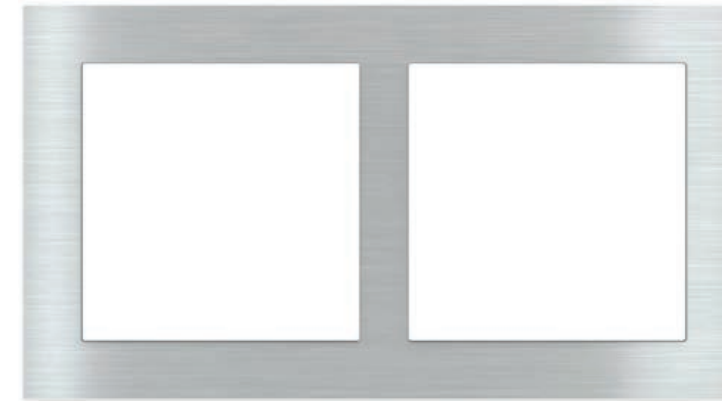
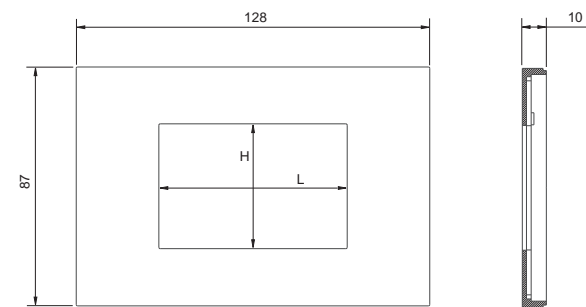

## Deep double plate

WALL-MOUNT DEVICES

### Description

Deep Series double plate for finishing standard flush-mounting inserts and/or Ekinex® devices of 20venti and 71 series. Available in several colours and materials.

### Main characteristics

- For mounting onto mounting boxes with fixing holes 71 mm apart
- In plastic material or aluminium or Fenix NTM®
- Two windows in five combinations
- Snap-on mounting on adapter

### Order information

Code	Windows L x H [mm]	For use with	Package
EK-D2E	45 x 45 (2)	two devices installed 71 mm apart (bus devices of 20venti and 71 series and/or flush-mounting inserts)	1 pcs.
EK-D2F	45 x 45 (1), 60 x 60 (1)		
EK-D2P-...	55 x 55 (2)		
EK-D2G-...	55 x 55 (1), 60 x 60 (1)		
EK-D2S-...	60 x 60 (2)		

### Delivery

Delivery of each Deep double plate includes an adapter (EK-A71-1-NF).

### Order

Base-codes must be completed by adding extensions for material, colour and finishing (3 characters).

### Dimensions [mm]

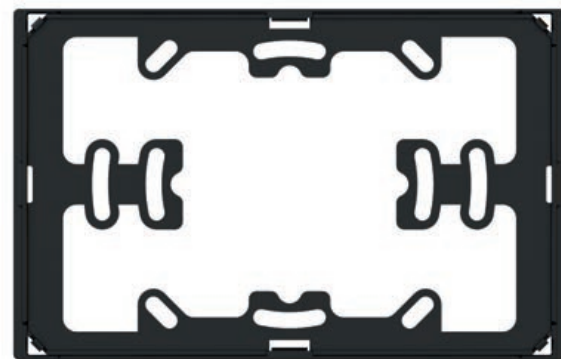
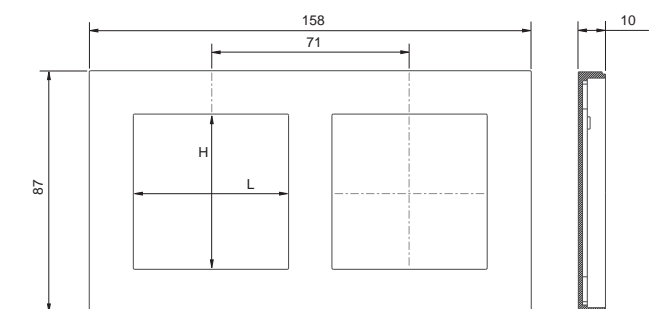

## Adapter for Deep rectangular plate

WALL-MOUNT DEVICES

### Description

Adapter for snap-on mounting of a Deep rectangular plate.

### Main characteristics

- Plastic material
- Side profile in black colour
- Mounting onto round or square mounting box with fixing holes 60 mm apart or onto rectangular mounting box with fixing holes 83,5 mm apart

### Order information

Code	For use with	Side profile	Package
EK-TAR-1-NF	Deep rectangular plate	black	1 pcs.
EK-TAR-5-NF			5 pcs.

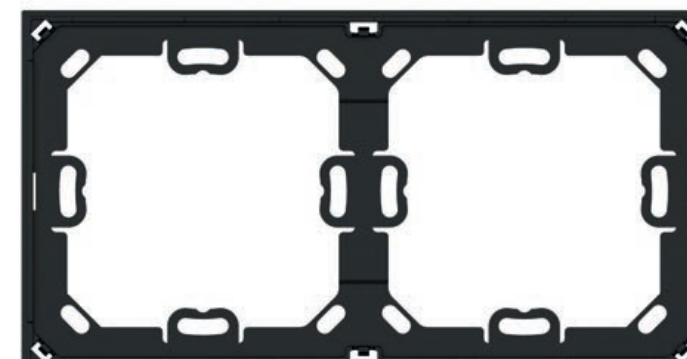

## Adapter for Deep double plate

WALL-MOUNT DEVICES

### Description

Adapter for snap-on mounting of a Deep double plate.

### Main characteristics

- In plastic material
- Side profile in black colour
- For mounting onto round modular flush-mounting boxes (71 mm apart)

### Order information

Code	For use with	Side profile	Package
EK-A71-1-NF	Deep double plate	black	1 pcs.
EK-A71-5-NF			5 pcs.

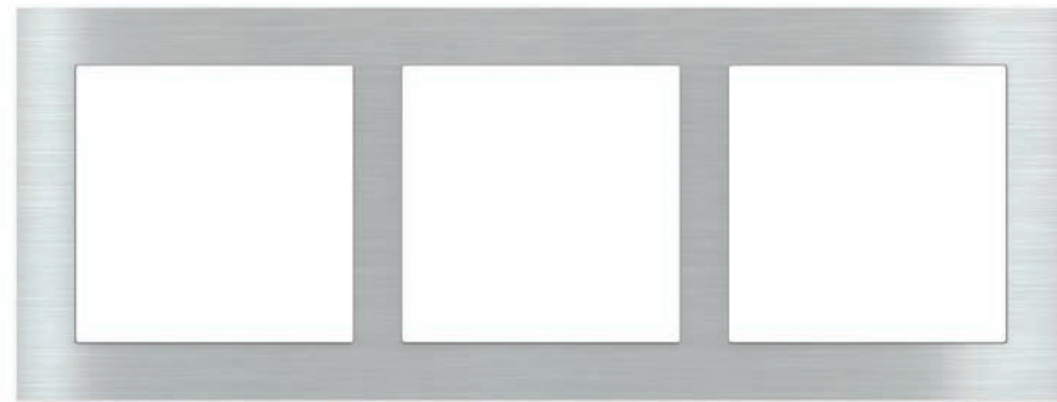

**Deep triple plate**  
WALL-MOUNT DEVICES

**Description**

Deep Series triple plate for finishing standard flush-mounting inserts and/or Ekinex® devices of 20venti and 71 series. Available in several colours and materials.

**Main characteristics**

- For mounting onto mounting boxes with fixing holes 71 mm apart
- In aluminium or Fenix NTM®
- Three windows in two combinations
- Snap-on mounting on adapter
- Customisation of windows on aluminium or Fenix NTM® plates on request

**Delivery**

Delivery of each Deep triple plate includes an adapter (EK-B71-1-NF).

**Order**

Base-codes must be completed by adding extensions for material, colour and finishing (3 characters).

**Dimensions [mm]**

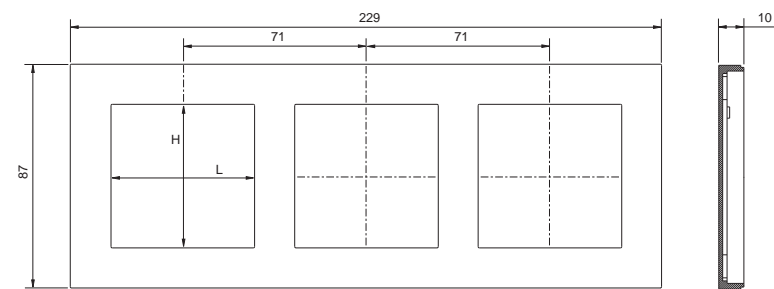

**Order information**

Code	Windows L x H [mm]	For use with	Package
EK-D3P-...	55 x 55 (3)	three devices installed 71 mm apart (bus devices of 20venti and 71 series and/or flush-mounting inserts)	1 pcs.
EK-D3S-...	60 x 60 (3)		

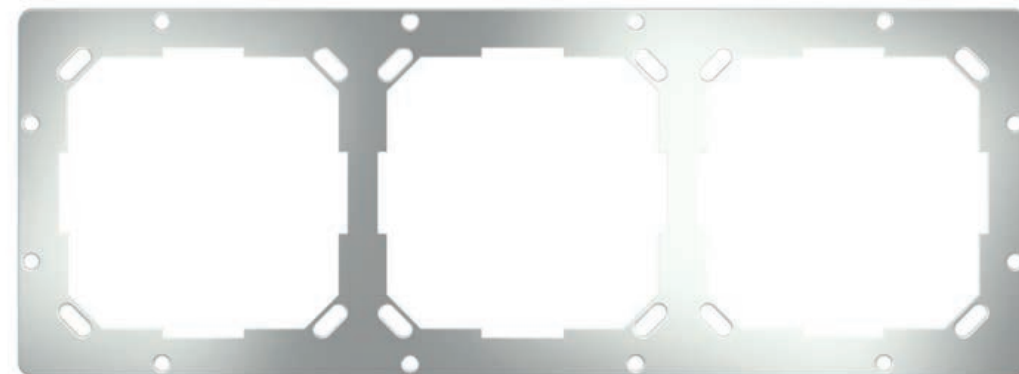

**Adapter for Deep triple plate**  
WALL-MOUNT DEVICES

**Description**

Adapter for snap-on mounting of a Deep triple plate.

**Main characteristics**

- In aluminium
- For mounting onto round modular flush-mounting boxes (71 mm apart)

**Order information**

Code	For use with	Side profile	Package
EK-B71-1-NF	Deep triple plate	black	1 pcs.
EK-B71-5-NF			5 pcs.

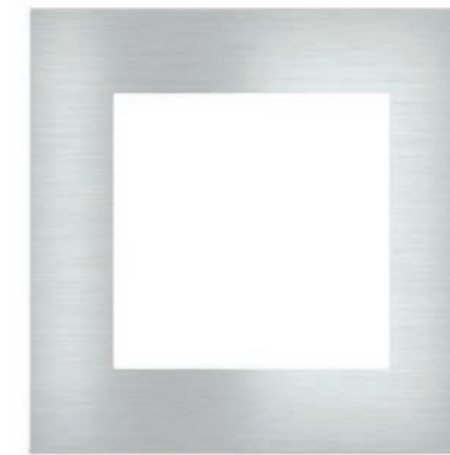

**Surface square plate**  
WALL-MOUNT DEVICES

**Description**

Surface Series square plate for finishing Ekinex® devices of 20venti and 71 series or market-standard flush-mounted inserts. Available in several colours and materials.

**Main characteristics**

- For use on round mounting box with fixing holes 60 mm apart
- In aluminium or Fenix NTM®
- Central window in four dimensions
- Snap-on mounting on adapter

**Delivery**

Delivery of each Surface square plate includes an adapter (EK-TAS-Q).

**Order**

Base-codes must be completed by adding extensions for material, colour and finishing (3 characters).

**Dimensions [mm]**

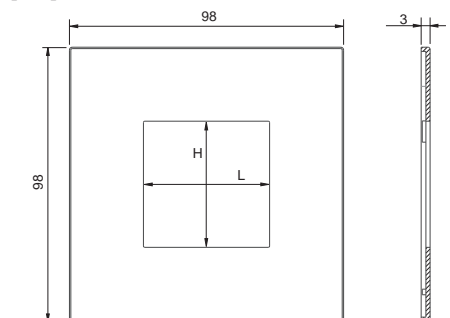

**Order information**

Code	Window L x H [mm]	For use with	Package
EK-SQP-...	45 x 45	standard flush-mounted inserts	1 pcs.
EK-SQG-...	55 x 55	standard flush-mounted inserts	
EK-SQT-...	30 x 60	devices of 20venti series (4 rockers)	
EK-SQS-...	60 x 60	devices of 20venti and 71 series	

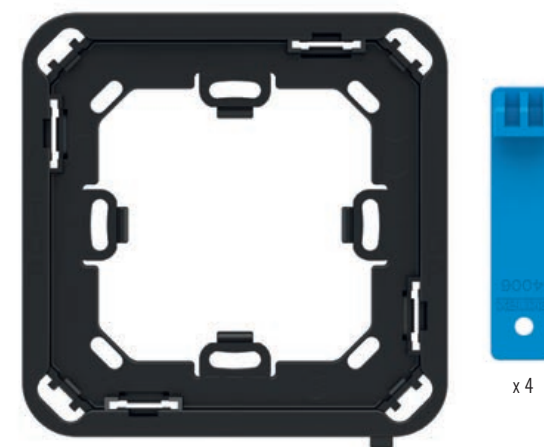

x 4

**Description**

Adapter for mounting of a Surface square plate.

**Main characteristics**

- Plastic material
- With fixing ties for plasterboard and movable walls
- Mounting onto round or square mounting box with fixing holes 60 mm apart

**Order information**

Code	For use with	Side profile	Package
EK-TAS-Q-1	Surface square plate	black	1 pcs.
EK-TAS-Q-5			5 pcs.



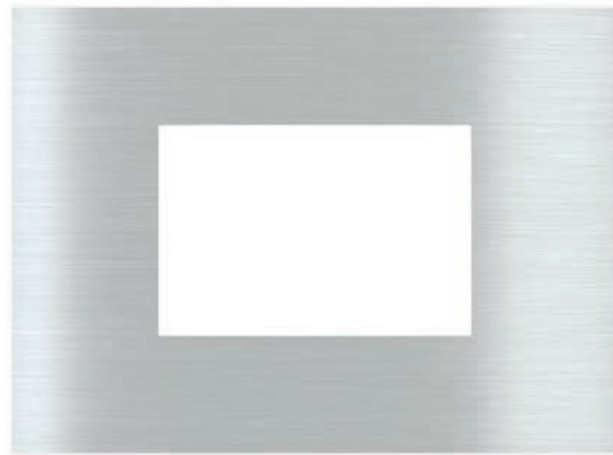

## Surface rectangular plate

WALL-MOUNT DEVICES

### Description

Surface Series rectangular plate for finishing Ekinex® devices of 20venti and 71 series or market-standard flush-mounted inserts. Mounting on 3 seater rectangular boxes. Available in several colours and materials.

### Main characteristics

- Mounting onto rectangular 3 seater mounting box according to the Italian installation standard provided with fixing holes 83,5 mm apart
- In aluminium or Fenix NTM®
- Central window in two dimensions
- Snap-on mounting on adapter

### Order information

Code	Window L x H [mm]	For use with	Package
EK-SRG-...	68 x 45	standard flush-mounted inserts	1 pcs.
EK-SRS	60 x 60	devices of 20venti and 71 series	

### Delivery

Delivery of each Surface rectangular plate includes an adapter (EK-TAS-R).

### Order

Base-codes must be completed by adding extensions for material, colour and finishing (3 characters).

### Dimensions [mm]

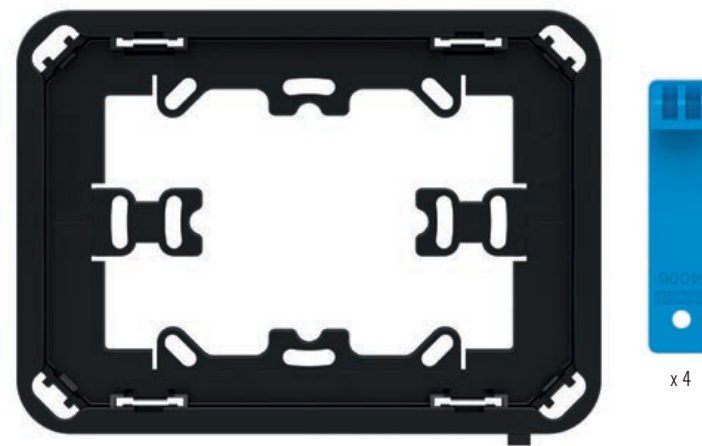
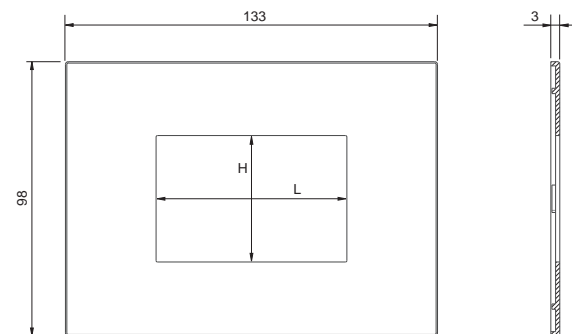

## Adapter for Surface rectangular plate

WALL-MOUNT DEVICES

### Accessories (included in the delivery)

Adapter for mounting of a Surface rectangular plate.

- Plastic material
- With fixing ties for plasterboard and movable walls
- Mounting onto rectangular 3 seater mounting box according to the Italian installation standard provided with fixing holes 83,5 mm apart

### Order information

Code	For use with	Side profile	Package
EK-TAS-R-1	Surface rectangular plate	black	1 pcs.
EK-TAS-R-5			5 pcs.

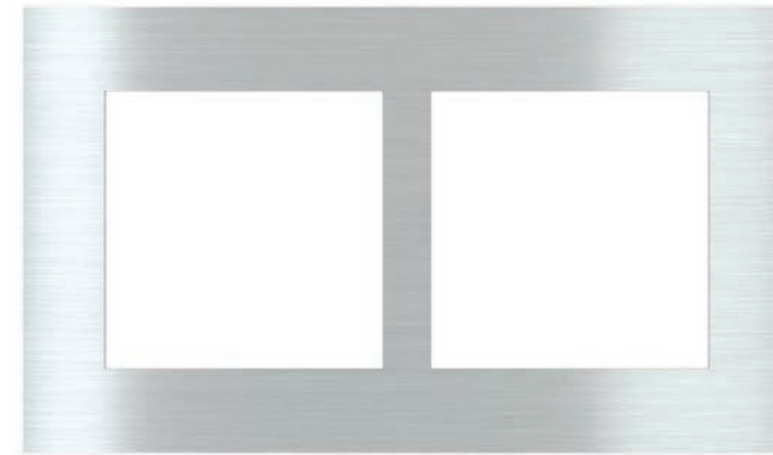

## Surface double plate

WALL-MOUNT DEVICES

### Description

Surface Series double plate for finishing standard flush-mounting inserts and/or Ekinex® devices of 20venti and 71 series. Available in several colours and materials.

### Main characteristics

- For mounting onto mounting boxes with fixing holes 71 mm apart
- In aluminium or Fenix NTM®
- Two windows in five combinations
- Snap-on mounting on adapter

### Order information

Code	Windows L x H [mm]	For use with	Package
EK-S2E	45 x 45 (2)	two devices installed 71 mm apart (bus devices of 20venti and 71 series and/or flush-mounting inserts)	1 pcs.
EK-S2F	45 x 45 (1), 60 x 60 (1)		
EK-S2P-...	55 x 55 (2)		
EK-S2G-...	55 x 55 (1), 60 x 60 (1)		
EK-S2S-...	60 x 60 (2)		

### Delivery

Delivery of each Surface double plate includes an adapter (EK-TAS-D).

### Order

Base-codes must be completed by adding extensions for material, colour and finishing (3 characters).

### Dimensions [mm]

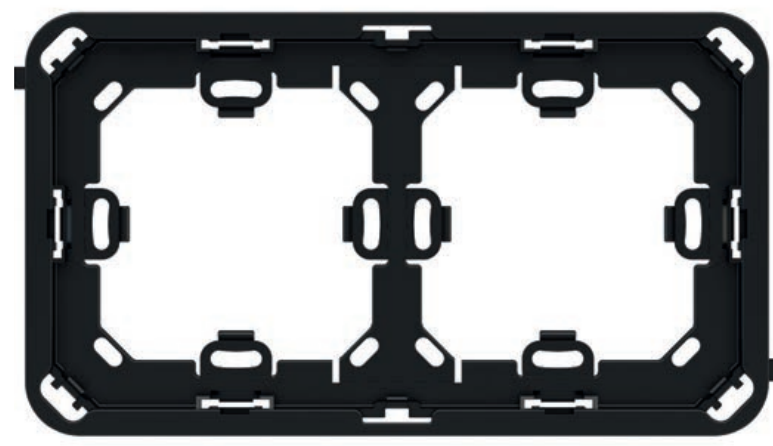
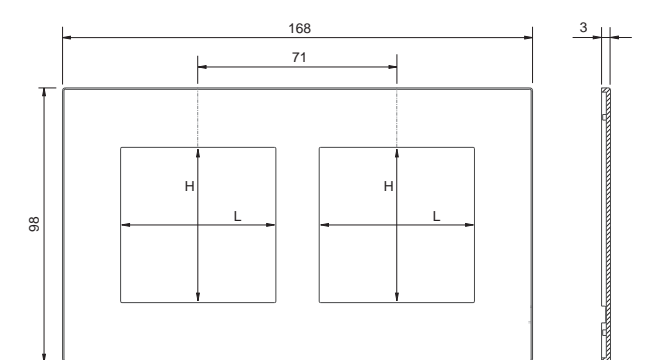

## Adapter for Surface double plate

WALL-MOUNT DEVICES

### Description

Adapter for mounting of a Surface double plate.

### Main characteristics

- Plastic material
- With fixing ties for plasterboard and movable walls
- For mounting onto mounting boxes with fixing holes 71 mm apart

### Order information

Code	For use with	Side profile	Package
EK-TAS-D-1	Surface double plate	black	1 pcs.
EK-TAS-D-5			5 pcs.

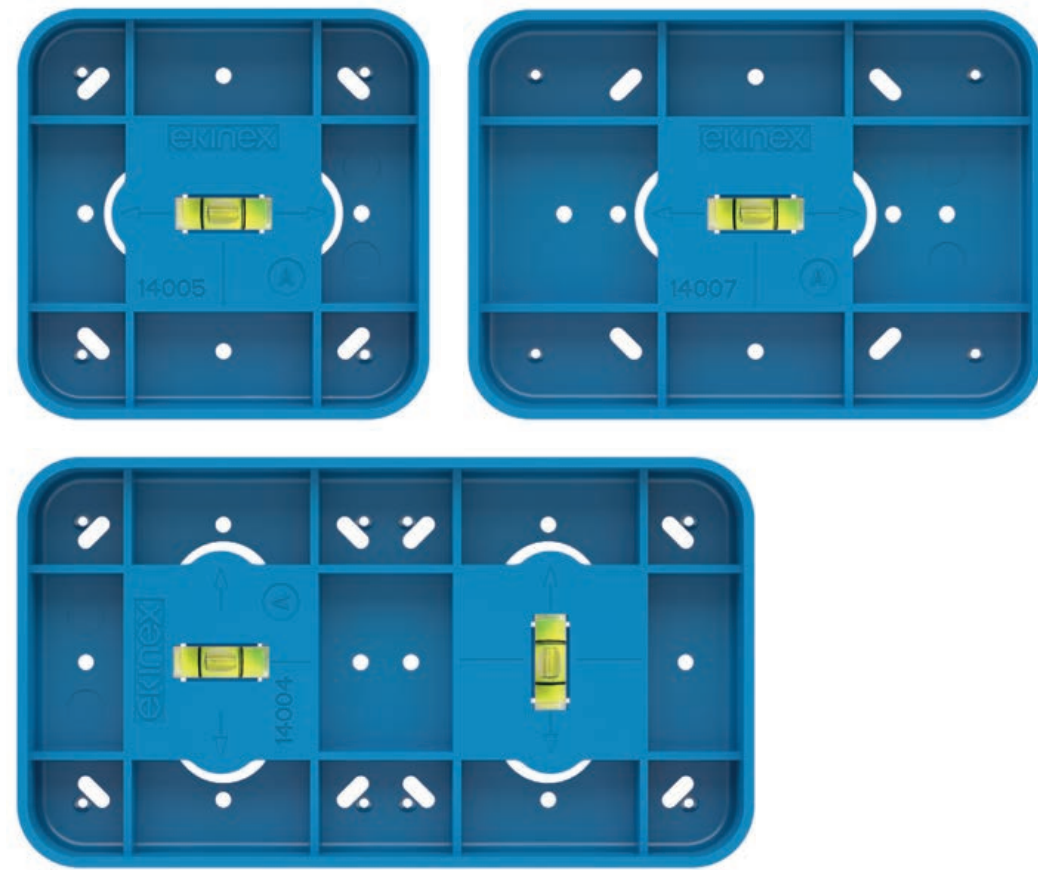

## Template for Surface plates

WALL-MOUNT DEVICES

## Double installation with fixing holes 60 mm apart

WALL-MOUNT DEVICES



### Description

Template for making holes during wall plastering in order to mount a Surface plate-adapter bundle.

### Main characteristics

- Plastic material
- With spirit level for perfect horizontal alignment
- Mounting onto round or square mounting box with fixing holes 60 mm apart

### Delivery

The template (EK-DPS-...) for mounting the Surface adapter-plate assembly must be ordered separately.

### Order information

Code	Dimensions L x H x P [mm]	For use with	Package
EK-DPS-Q-1	87 x 87 x 25	Template for square plate	
EK-DPS-R-1	122 x 87 x 25	Template for rectangular plate	1 pcs.
EK-DPS-D-1	157 x 87 x 25	Template for double plate	
EK-DPS-Q-5	87 x 87 x 25	Template for square plate	
EK-DPS-R-5	122 x 87 x 25	Template for rectangular plate	5 pcs.
EK-DPS-D-5	157 x 87 x 25	Template for double plate	

The double plate with 120 x 60 mm window (c) allows two Ekinex® 20venti or 71 series devices (a), one Ekinex® 20venti or 71 series device (a) and one market-standard component for round box 60 x 60 mm (b) or two market-standard component for round box 60 x 60 mm (b) to be mounted side-to-side with fixing holes 60 mm apart. The plate can be mounted without frame ('NF') or with double frame Form (p) or Flank (q) series. The installation can be horizontal or vertical thanks to the proper supports (l). The double plate with 120 x 60 mm window is available in aluminium or Fenix NTM®.

**Note.** In order to use Ekinex® double plates or frames, it is necessary to use a double (r) or two single modular flush-mounting boxes (s) which guarantee a fixing hole distance of 60 mm between the devices. The front size of the boxes (L x H) cannot exceed the dimension of the double plate EK-P2C-... (mounting without frame 'NF') or that of the double frames Form (EK-FO2-...) or Flank (EK-FL2-...) series.

### Flush-mounting box prerequisites:

- Fixing holes on the corners
- Size limits (L x H) indicated in the table below

### Flush-mounting box dimensions [mm]

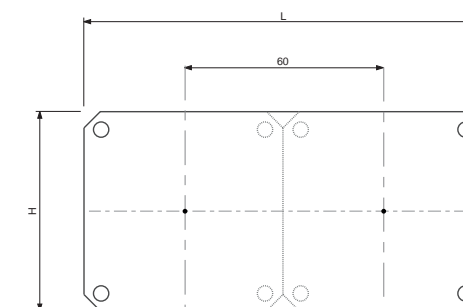

### Double installation (flush-mounting boxes with fixing holes 60 mm apart)

Mounting	Max. dimensions (L x H) built-in case [mm]
Frame-free	151 x 80
Double frame Form series (EK-FO2-...)	157 x 86
Double frame Flank series (EK-FL2-...)	165 x 80



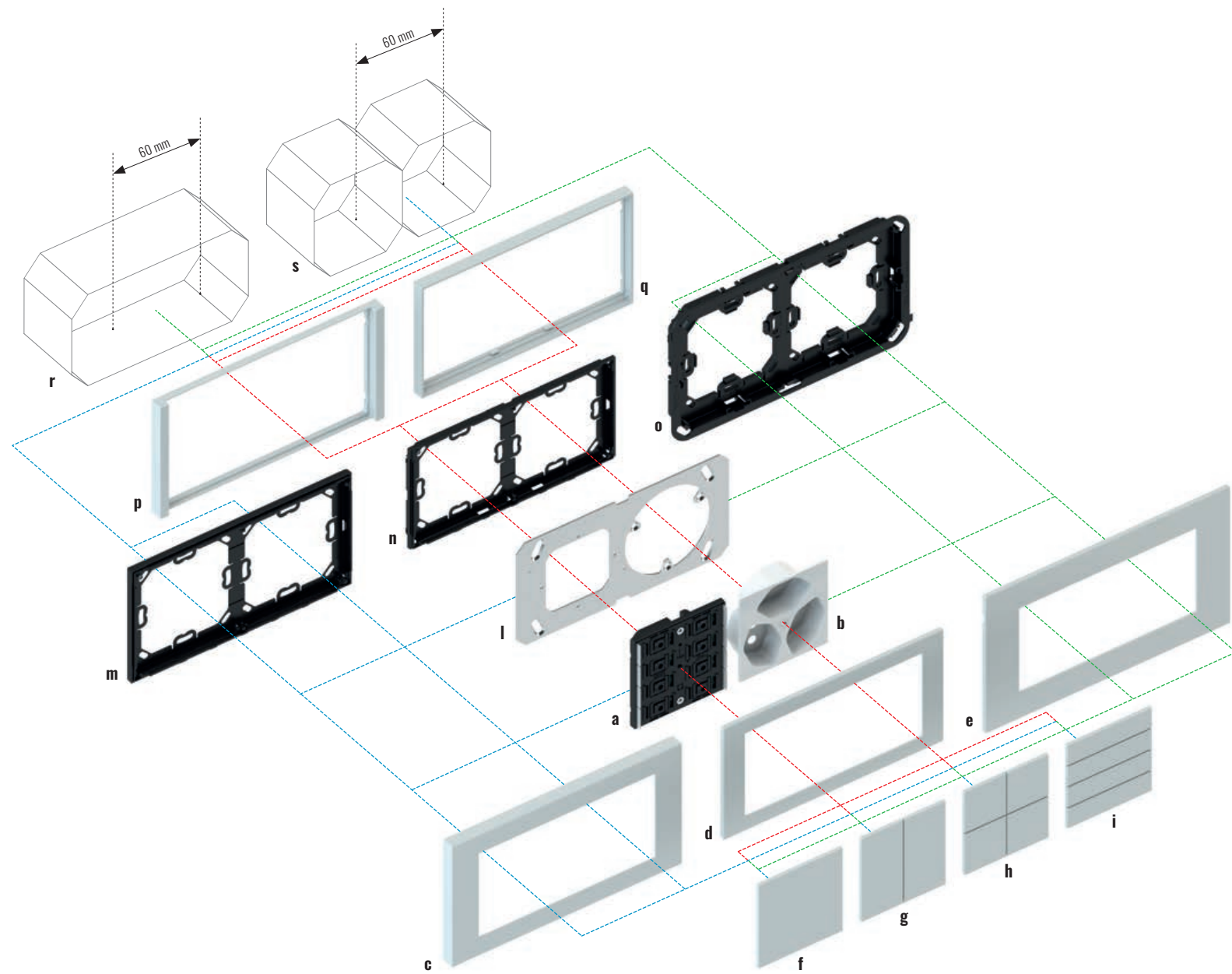

Double installation (built-in cases with 60 mm device centre distance) - 71 series

Description	Code	Page
a) 71 series pushbutton	EK-E12-TP-... o EK-E22-TP-...	90-92
b) 60x60 mm civil series component	not delivered by Ekinex®	-
c) Deep double plate*	EK-D2C-...	150
d) 'NF' double plate*	EK-P2C-...	150
e) Surface double plate*	EK-S2C-...	151
f) Square rocker (1)	EK-T1Q-...	117
g) Rectangular vertical rockers (2)	EK-T2R-...	117
h) Square rockers (4)	EK-T4Q-...	117
i) Rectangular horizontal rockers (4)	EK-T4R-...	117
l) Installation metal supports**	EK-SM2-CH...	149

Description	Code	Page
m) Double adapter for frame-free installation	EK-A71-...-NF	150
n) Double adapter for Form or Flank frame installation***	EK-A71-...	138
o) Double adapter for Surface double plate	EK-TAS-D-...	151
p) Flank series double frame (with adapter)	EK-FL2-...	135
q) Form series double frame (with adapter)	EK-FQ2-...	135
r) Double case (device centre distance 60 mm)	not delivered by Ekinex®	-
s) Single cases (60 mm device centre distance)	not delivered by Ekinex®	-
*) 120 x 60 mm single window		
**) Available for horizontal or vertical mounting		
***) Included with the purchase of each double frame Form or Flank series		

## Double supports for installation with 60 mm device centre distance

WALL-MOUNT DEVICES



**Description**

Metal double support for 60 mm centre distance installation of two Ekinex® 20venti or 71 series devices, one Ekinex® 20venti or 71 series device and one or two components for round case (Feller only). Fitting screws included.

**Vertical installation**

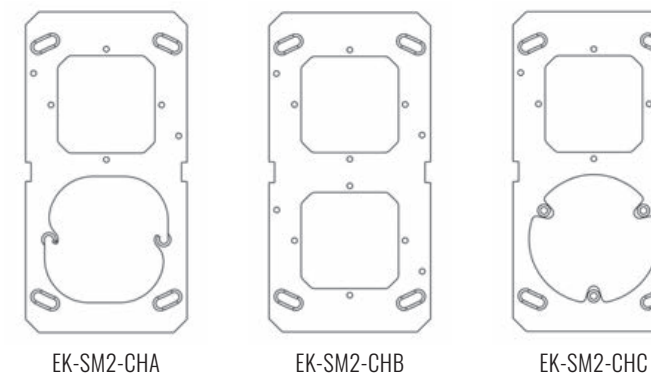

**Horizontal installation**

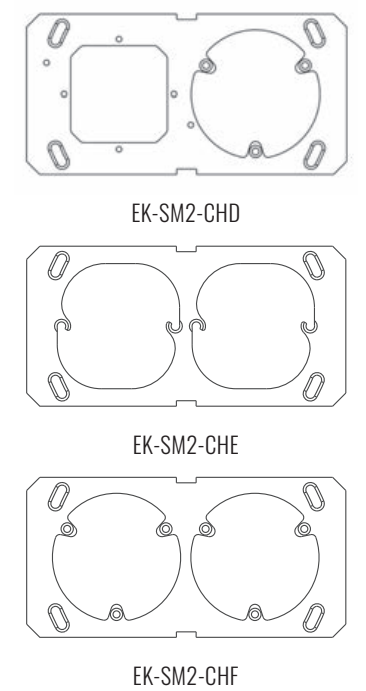

**Dimensions [mm]**

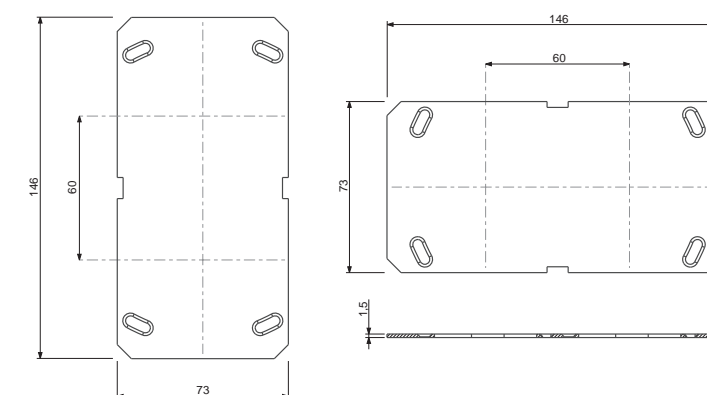

**Order information**

Code	Installation	Description
EK-SM2-CHA	vertical	1 housing for Ekinex® 20venti or 71 series device, 1 housing with double dovetail connection
EK-SM2-CHB	vertical	2 housings for Ekinex® 20venti or 71 series devices
EK-SM2-CHC	vertical	1 housing for Ekinex® 20venti or 71 series device, 1 housing with 120° triple connection
EK-SM2-CHD	horizontal	1 housing for Ekinex® 20venti or 71 series device, 1 housing with 120° triple connection
EK-SM2-CHE	horizontal	2 housings with double dovetail connection
EK-SM2-CHF	horizontal	2 housing with 120° triple connection

Other double supports are available on request



## 'NF and Deep plate with 120 x 60 mm window

WALL-MOUNT DEVICES

### Description

Double plate with 120 x 60 mm window for 60 mm centre distance installation of two Ekinex® 20venti or 71 series devices, one Ekinex® 20venti or 71 series device and one round case component or two round case components. Round case components should have a 60 x 60 mm dimension. For use with series Form or Flank double frame or for frame-free installation combined to an EK-A71 adapter.

### Main characteristics

- In aluminium or Fenix NTM®
- Snap-on installation

### Order information

Code	Window L x H [mm]	Use	Package
EK-P2C-... ('NF)*	120 x 60	Installation of 2 devices with a 60-mm centre distance	1 pcs.
EK-D2C-... (Deep)			

\*) Frame-free installation ('NF) requires use of dedicated adapter (sold separately, see below)

### Orders

The basic code (EK-P2C - EK-D2C) must be combined to extensions of the same material and colour (3 characters).

### Note

The adapter for mounting with double frame of Form or Flank series (EK-A71) is included in the delivery of the frame. Delivery of each Deep plate includes an adapter (EK-A71-1-NF).

### Dimensions [mm]

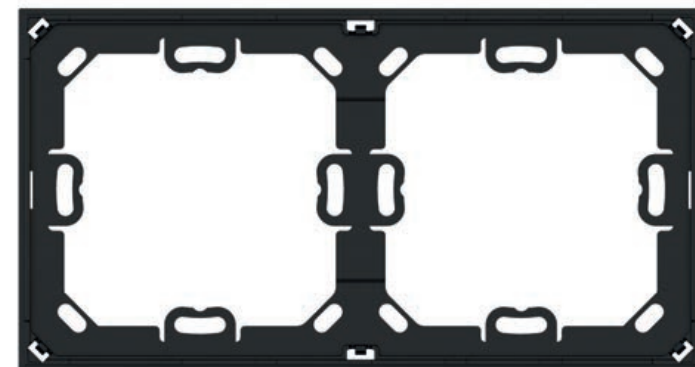
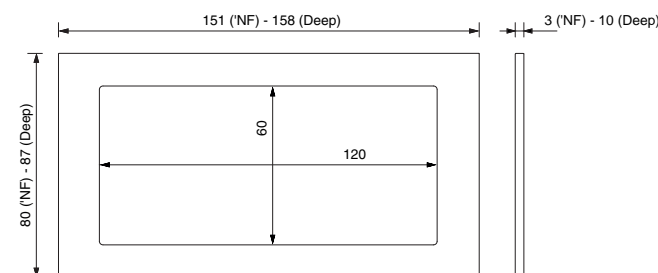

## Adapter for 'NF and Deep plate with 120 x 60 mm window

WALL-MOUNT DEVICES

### Order information

Code	For use with	Side profile	Package
EK-A71	double plate with a Form or Flank frame	-	10 pcs.
EK-A71-1-NF	double plate without frame ('NF and Deep series)	black	1 pcs.
EK-A71-5-NF			5 pcs.

### Description

Installation adapter for one frame-free double plate (series 'NF and Deep).

### Main characteristics

- Plastic
- Side profile available in black



## Surface plate with 120 x 60 mm window

WALL-MOUNT DEVICES

### Description

Double plate with 120 x 60 mm window for 60 mm centre distance installation of two Ekinex® 20venti or 71 series devices, one Ekinex® 20venti or 71 series device and one round case component or two round case components. Round case components should have a 60 x 60 mm dimension.

### Main characteristics

- In aluminium or Fenix NTM®
- Snap-on installation

### Order information

Code	Window L x H [mm]	Use	Package
EK-S2C-... (Surface)	120 x 60	Installation of 2 devices with a 60-mm centre distance	1 pcs.

### Orders

The basic code (EK-S2C) must be combined to extensions of the same material and colour (3 characters).

### Note

Delivery of each Surface double plate includes an adapter (EK-TAS-D).

### Dimensions [mm]

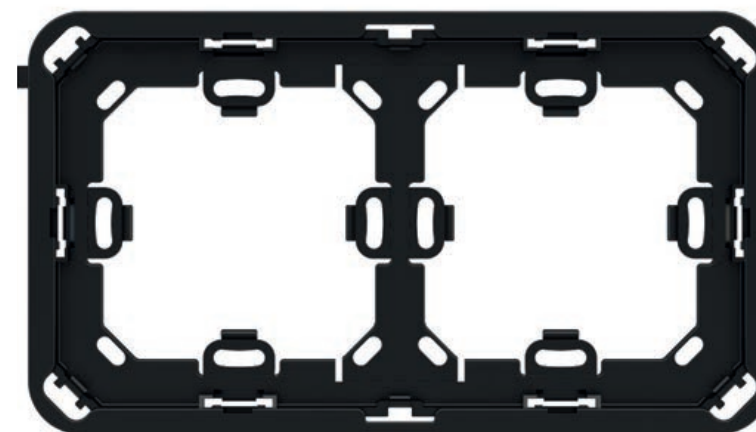
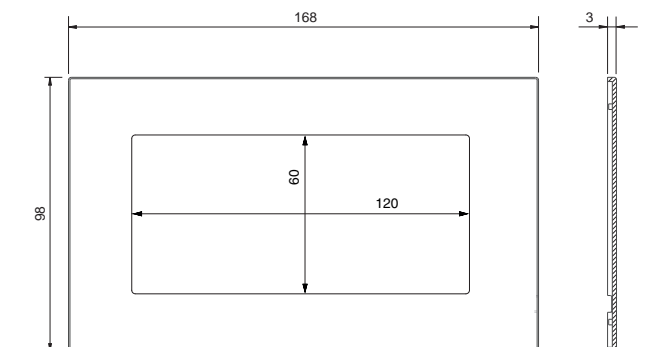

x 6

## Adapter for Surface plate with 120 x 60 mm window

WALL-MOUNT DEVICES

### Description

Adapter for mounting of a Surface double plate.

### Main characteristics

- Plastic material
- With fixing ties for plasterboard and movable walls
- For mounting onto mounting boxes with fixing holes 71 mm apart

### Order information

Code	For use with	Side profile	Package
EK-TAS-D-1	Surface double plate	black	1 pcs.
EK-TAS-D-5			5 pcs.



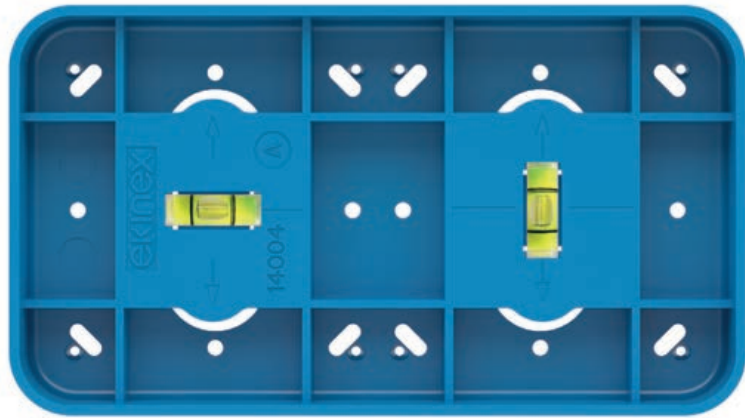

## Template for Surface plate with 120 x 60 mm window

WALL-MOUNT DEVICES

### Description

Template for making holes during wall plastering in order to mount a Surface plate-adapter bundle.

### Main characteristics

- Plastic material
- With spirit level for perfect horizontal alignment
- Mounting onto round or square mounting box with fixing holes 60 mm apart

### Delivery

The template (EK-DPS-...) for mounting the Surface adapter-plate assembly must be ordered separately.

#### Order information

Code	Dimensions L x H x P [mm]	For use with	Package
EK-DPS-D-1	157 x 87 x 25	Template for double plate	1 pcs.
EK-DPS-D-5	157 x 87 x 25		5 pcs.

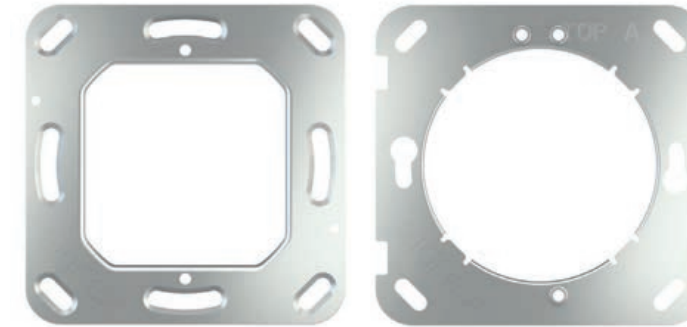

### Description

Square metallic support for mounting Ekinex® devices of 20venti, FF or 71 series onto round or square mounting boxes with fixing holes 60 mm apart. Fixing screws are provided.

### Note

A mounting support is delivered with each Ekinex® device of 20venti, FF and 71 series.

#### Order information

Code	Dimensions L x H x P [mm]	For use with	Package
EK-SMQ	72 x 70 x 5	thermostats and Touch&See FF series	5 pcs.
EK-SMQ-71	70 x 70 x 4,5	devices of 20venti or 71 series and 4-fold pushbutton of FF series	5 pcs.

#### Dimensions [mm]

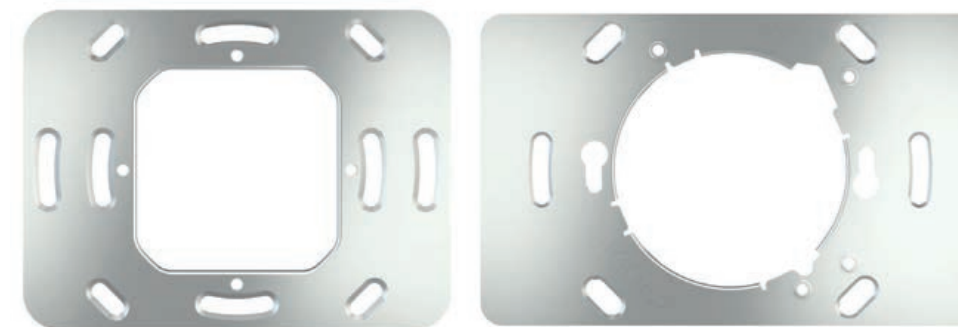
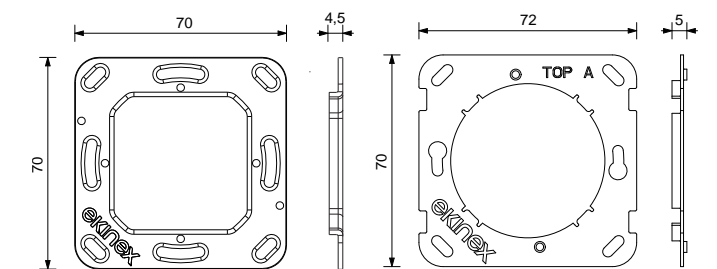

## Rectangular mounting support

WALL-MOUNT DEVICES

### Description

Rectangular metallic support for mounting Ekinex® devices of 20venti, FF or 71 series onto round or square mounting boxes with fixing holes 60 mm apart or onto rectangular, 3-seater mounting box with fixing holes 85 mm apart. Fixing screws are provided.

### Note

A mounting support is delivered with each Ekinex® device of 20venti, FF and 71 series.

#### Order information

Code	Dimensions L x H x P [mm]	For use with	Package
EK-SMR	110 x 68 x 5	Touch&See with 2-fold pushbutton of FF series	5 pcs.
EK-SMR-71	93,5 x 70 x 4,5	devices of 20venti or 71 series and 4/6-fold pushbutton of FF series	

#### Dimensions [mm]

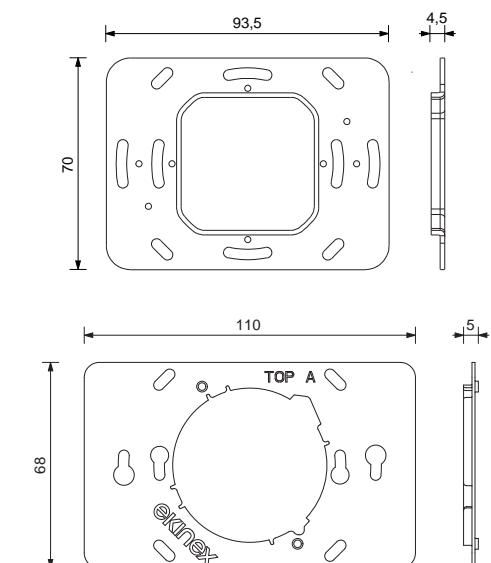

## Colour solutions

WALL-MOUNT DEVICES

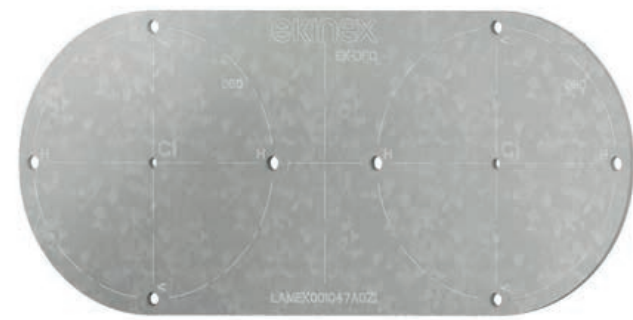

## Template for side-by-side mounting of FF series with Form frames

WALL-MOUNT DEVICES

### Description

Template for horizontal or vertical double-mounting of two Ekinex® devices of FF series with square frame of the Form series. Made of zinc-plated metal sheet, 1 mm thick. Employ depends on wall type (brick or panels).

### Order information

Code	Frames	For use with	Package
EK-DFO	Form	2 devices of FF series completed with square Form frames	5 pcs.

### Dimensions [mm]

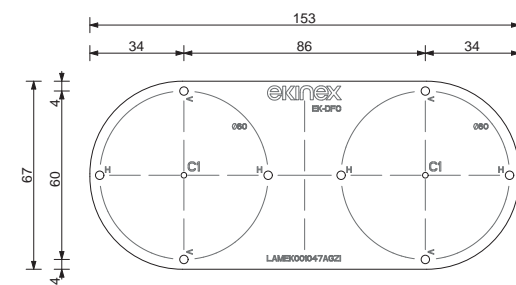

## Template for side-by-side mounting of FF series with Flank frames

WALL-MOUNT DEVICES

### Description

Template for horizontal or vertical double-mounting of two Ekinex® devices of FF series with square frame of the Flank series. Made of zinc-plated metal sheet, 1 mm thick. Employ depends on wall type (brick or panels).

### Order information

Code	Frames	For use with	Package
EK-DFL	Flank	2 devices of FF series completed with square Flank frames	5 pcs.

### Dimensions [mm]

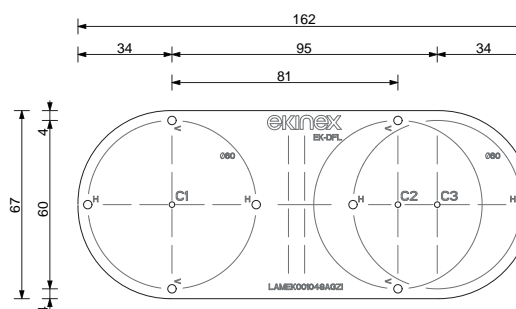

### METAL

<b>GBQ</b> Aluminium Brushed finishing	<b>GBR</b> Nickel Brushed finishing	<b>GBS</b> Titanium Brushed finishing
<b>Frames</b> FF-71 Form FF-71 Flank	<b>Frames</b> FF-71 Form FF-71 Flank	<b>Frames</b> FF-71 Form FF-71 Flank
<b>Plates</b> 20venti FF 71	<b>Plates</b> 20venti FF 71	<b>Plates</b> 20venti FF 71
<b>Rockers</b> FF 71	<b>Rockers</b> FF 71	<b>Rockers</b> FF 71
<b>GBU</b> Carbon Brushed finishing	<b>GBB</b> Brass Brushed finishing	
<b>Frames</b> FF-71 Form FF-71 Flank	<b>Frames</b> FF-71 Form FF-71 Flank	
<b>Plates</b> 20venti FF 71	<b>Plates</b> 20venti FF 71	
<b>Rockers</b> FF 71	<b>Rockers</b> FF 71	

### FENIX NTM®

<b>FBM</b> White Malè	<b>FBL</b> Beige Luxor	<b>FCO</b> Beaver Ottawa	<b>FGE</b> Grey Efeso	<b>FGL</b> Grey London
<b>Frames</b> FF-71 Form	<b>Frames</b> FF-71 Form	<b>Frames</b> FF-71 Form	<b>Frames</b> FF-71 Form	<b>Frames</b> FF-71 Form
<b>Plates</b> 20venti FF 71	<b>Plates</b> 20venti FF 71	<b>Plates</b> 20venti FF 71	<b>Plates</b> 20venti FF 71	<b>Plates</b> 20venti FF 71
<b>Rockers</b> FF 71	<b>Rockers</b> FF 71	<b>Rockers</b> FF 71	<b>Rockers</b> FF 71	<b>Rockers</b> FF 71
<b>FGB</b> Grey Bromine	<b>FVC</b> Green Commodore	<b>FCC</b> Cocoa Orinoco	<b>FNI</b> Black Ingo	
<b>Frames</b> FF-71 Form	<b>Frames</b> FF-71 Form	<b>Frames</b> FF-71 Form	<b>Frames</b> FF-71 Form	
<b>Plates</b> 20venti FF 71	<b>Plates</b> 20venti FF 71	<b>Plates</b> 20venti FF 71	<b>Plates</b> 20venti FF 71	
<b>Rockers</b> FF 71	<b>Rockers</b> FF 71	<b>Rockers</b> FF 71	<b>Rockers</b> FF 71	

### PLASTIC

<b>GAA</b> White	<b>GAE</b> Intense black RAL 9005	<b>GAG</b> Silver metallic plastic
<b>Frames</b> FF-71 Form FF-71 Flank	<b>Frames</b> FF-71 Form FF-71 Flank	<b>Frames</b> FF-71 Form FF-71 Flank
<b>Plates</b> 20venti Deep FF 'NF e Deep 71 'NF e Deep	<b>Plates</b> 20venti Deep FF 'NF e Deep 71 'NF e Deep	<b>Plates</b> 20venti Deep FF 'NF e Deep 71 'NF e Deep
<b>Rockers</b> 20venti FF - 71	<b>Rockers</b> 20venti FF - 71	<b>Rockers</b> 20venti FF - 71

### PLASTIC ON REQUEST

<b>GAB</b> Ice white* Soft-touch finish	<b>GAC</b> Fire white*	<b>GAD</b> Fire white* Soft-touch finish
<b>Frames</b> FF-71 Form FF-71 Flank	<b>Frames</b> FF-71 Form FF-71 Flank	<b>Frames</b> FF-71 Form FF-71 Flank
<b>Plates</b> 20venti Deep FF 'NF e Deep 71 'NF e Deep	<b>Plates</b> 20venti Deep FF 'NF e Deep 71 'NF e Deep	<b>Plates</b> 20venti Deep FF 'NF e Deep 71 'NF e Deep
<b>Rockers</b> FF - 71	<b>Rockers</b> 20venti FF - 71	<b>Rockers</b> FF - 71
<b>GAF</b> Intense black* Soft-touch RAL 9005	<b>GAI</b> Hematite* metallic plastic	<b>GAL</b> Graphite* metallic plastic
<b>Frames</b> FF-71 Form FF-71 Flank	<b>Frames</b> FF-71 Form FF-71 Flank	<b>Frames</b> FF-71 Form FF-71 Flank
<b>Plates</b> 20venti Deep FF 'NF e Deep 71 'NF e Deep	<b>Plates</b> 20venti Deep FF 'NF e Deep 71 'NF e Deep	<b>Plates</b> 20venti Deep FF 'NF e Deep 71 'NF e Deep
<b>Rockers</b> FF - 71	<b>Rockers</b> 20venti FF - 71	<b>Rockers</b> 20venti FF - 71

### \* ON REQUEST

The range finishes shown on the left are the result of a company stylistic choice. Additional finishes in Fenix NTM® and metal are also available upon request (non-standard processes may be subject to limitation).



## Ekinex chooses Fenix NTM®

WALL-MOUNT DEVICES

**A super opaque nanotech material, is an innovative interior design product, that combines elegant aesthetic solutions with state-of-the-art technological performance.**

The external Surface of Fenix NTM® involves the use of nanotechnology and it is characterized by next generation acrylic resins, hardened and fixed with Electron Beam Curing process opening up new avenues in the field of interior design. With low light reflectivity, its Surface is extremely opaque, anti-fingerprint and features a very pleasant soft touch. Thanks to the use of nano-technologies, Fenix NTM® thermally heals any superficial micro-scratches, as its name indicates. In addition, Fenix NTM® is highly resistant to scratches, abrasion, rubbing and dry heat. It also withstands impacts, acid-based solvents and household reagents. It significantly reduces the bacterial load making its Surface hygienic and easy to clean. It is also liquid repellent and mould-proof. **For more information:** <https://en.ekinex.com/fenix-ntm.html>



Low light reflectivity



Thermal healing of microscratches



Anti-fingerprint



Soft touch

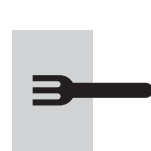

Resistance to scratches and abrasion



Resistance to dry heat



High resistance to acid solvents and household reagents



Enhanced anti-bacterial properties



Hygienic



Suitable for contact with food



Easy to clean



Mold-resistant



Antistatic



Hydro-repellent



Dimensional stability even at high temperature changes



Resistance to impact



Lightfastness



Excellent intensity and colour depth



Rub resistance



Self-supporting (only for 10 and 12 mm)

Rockers for devices of 20venti, FF and 71 series can be customized with symbols from the library on the following pages. Upon request, it is also possible to customize rockers with symbols and text provided by the customer.

### Square rockers

The code extension includes 3 characters identifying material, colour and finishing and 3 more characters identifying symbols. Within the last 3-character group, the first character identifies a double symbol, while the second and third characters identify a single symbol.

#### Single symbol

The single symbol is reproduced in the central part of the square rocker, centred both horizontally and vertically. If the second and third characters of the extension-code equal "0", the rocker has no single symbol.

#### Double symbol

The double symbol is reproduced in the upper and lower part of the square rocker, both centred horizontally. If the first character in the extension-code equals "0", the rocker has no double symbol.

### Vertical rectangular rockers

The code extension includes 3 characters identifying material, colour and finishing and 3 more characters identifying symbols. Within the last 3-character group, the first character identifies a double symbol, while the second and third characters identify a single symbol.

#### Single symbol

The single symbol is reproduced in the central part of the rectangular rocker, centred both horizontally and vertically. If the second and third characters of the extension-code equal "0", the rocker has no single symbol.

#### Double symbol

The double symbol is reproduced in the upper and lower part of the rectangular rocker, both centred horizontally. If the first character in the extension-code equals "0", the rocker has no double symbol.

### Horizontal rectangular rockers

The code extension includes 3 characters identifying material, colour and finishing and 3 more characters identifying symbols. Within the last 3-character group, the first character identifies a double symbol, while the second and third characters identify a single symbol.

#### Single symbol

The single symbol is reproduced in the central part of the rectangular rocker, centred both horizontally and vertically. If the second and third characters of the extension-code equal "0", the rocker has no single symbol.

#### Double symbol

The double symbol is reproduced on the left and right sides of the rectangular rocker, vertically centred. If the first character in the extension-code equals "0", the rocker has no double symbol.

## Symbols for rockers customization

WALL-MOUNT DEVICES

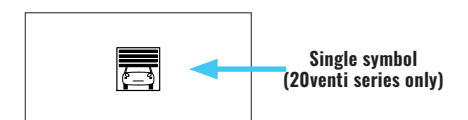
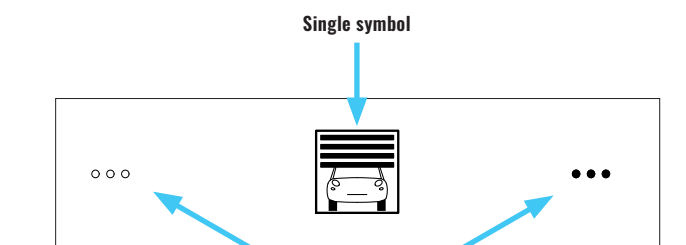
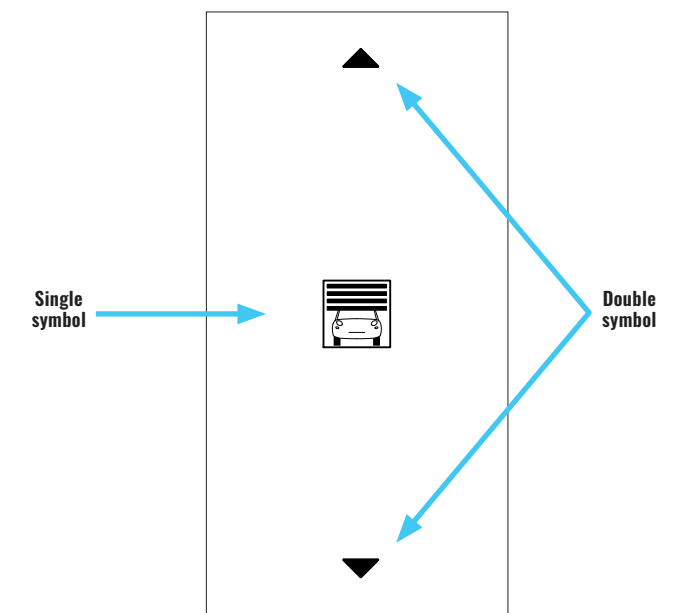
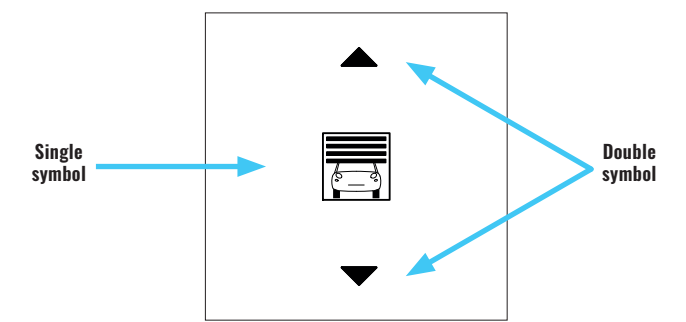

## Single symbols



## Lighting

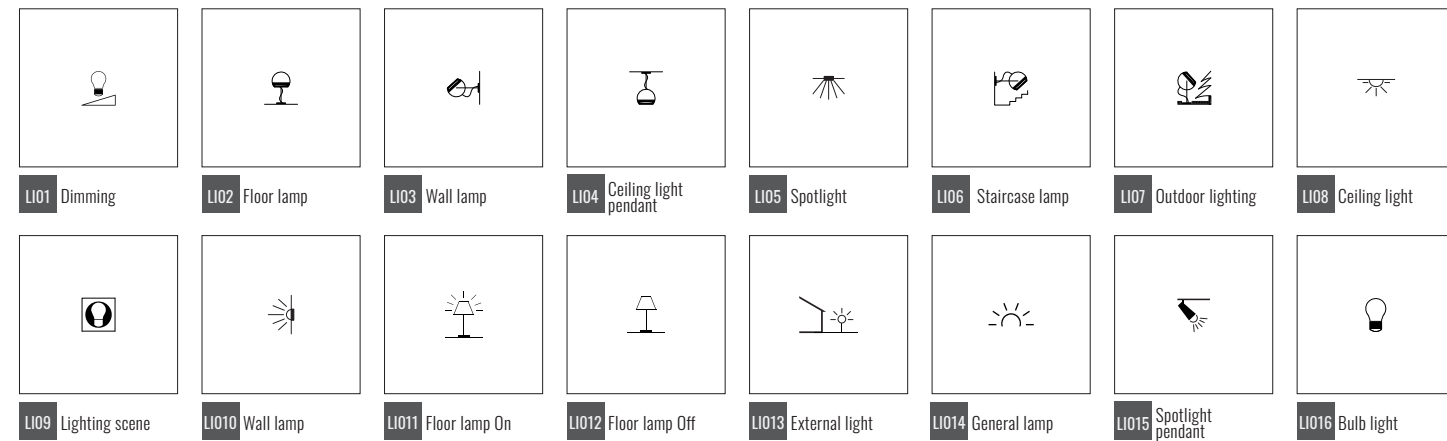

## Multimedia

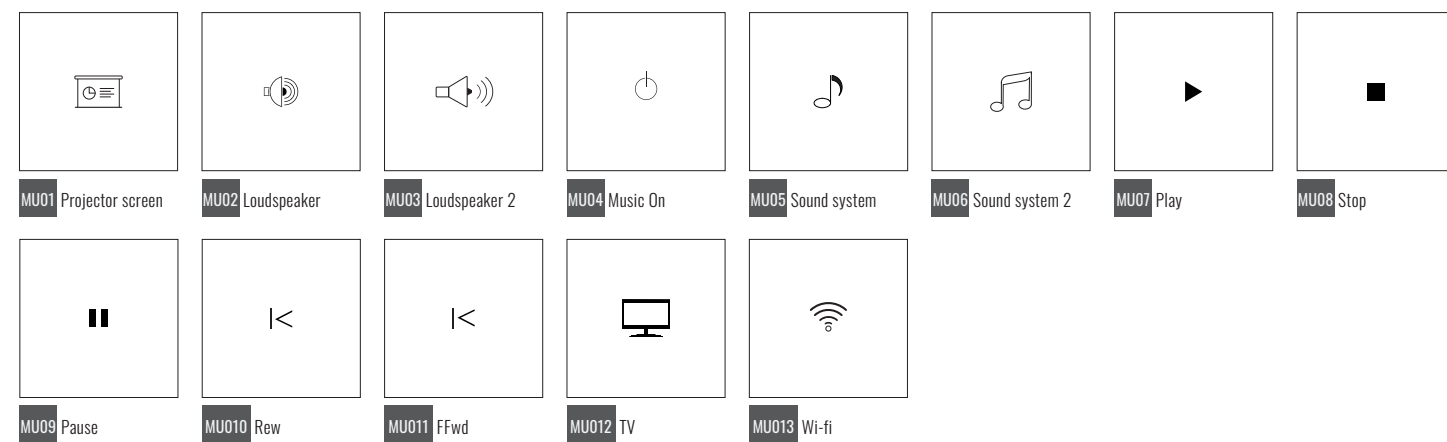

## Health and care

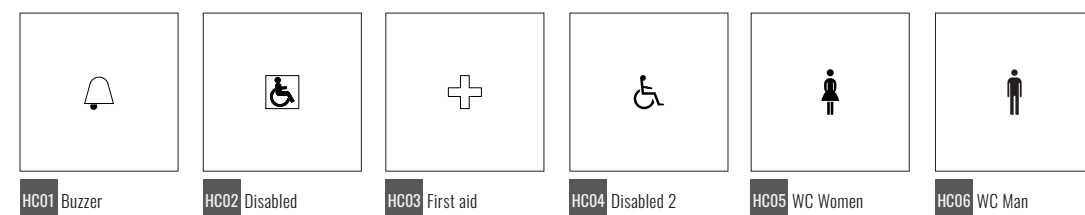

## Door and garage

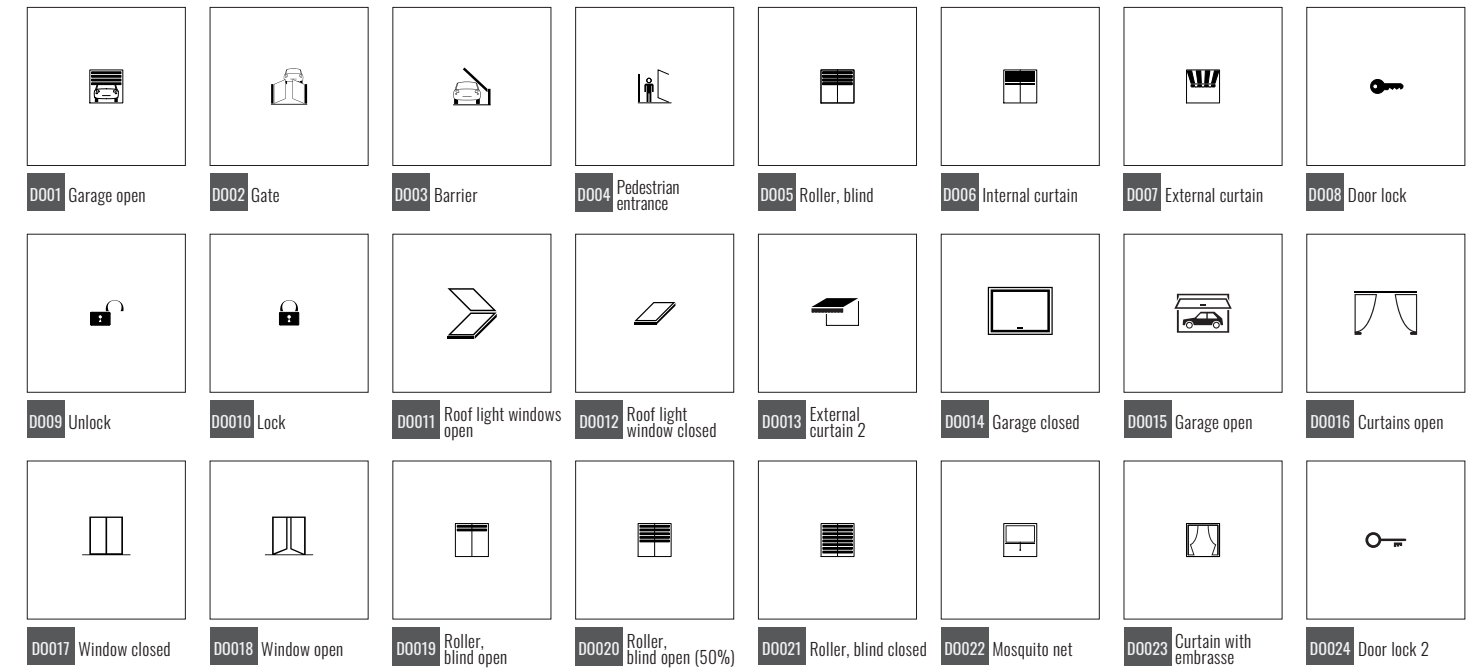

## Hotel



## Energy

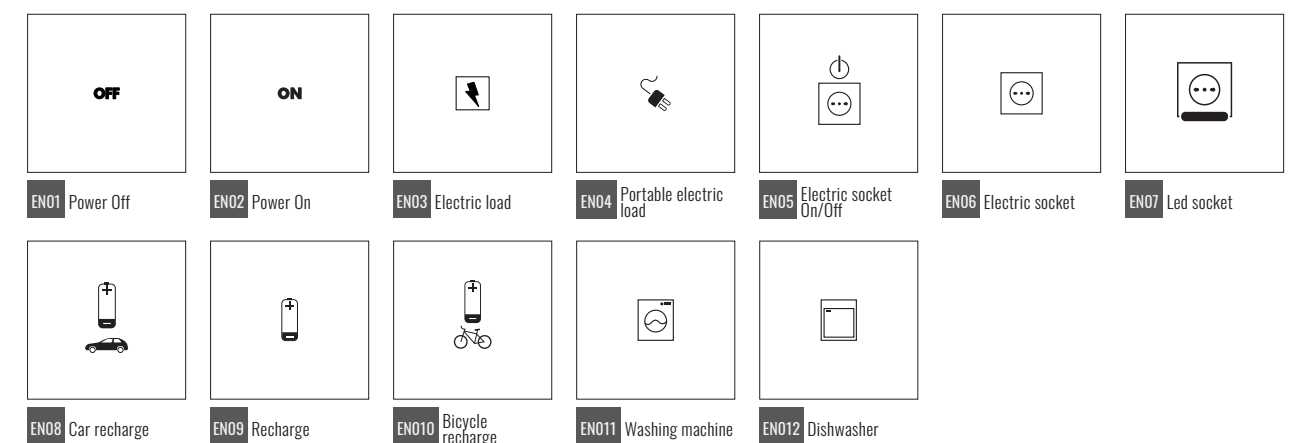

\* Not available for 20venti series with backlit texts and symbols



## Climate

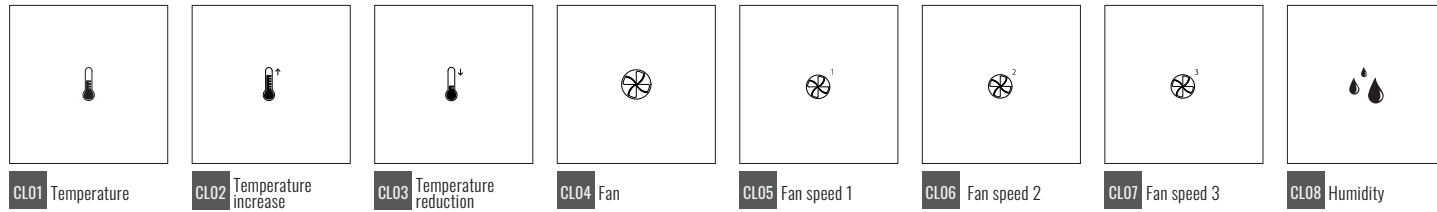

## Scene

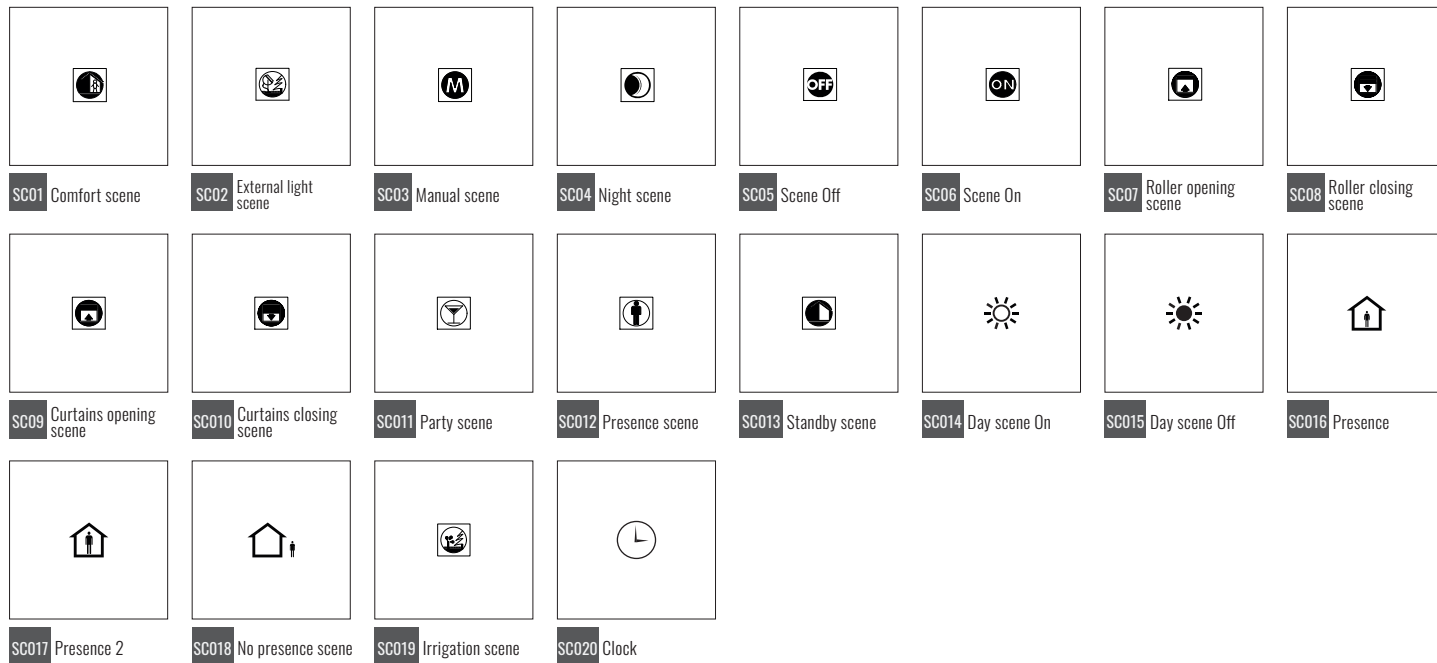

## Marker

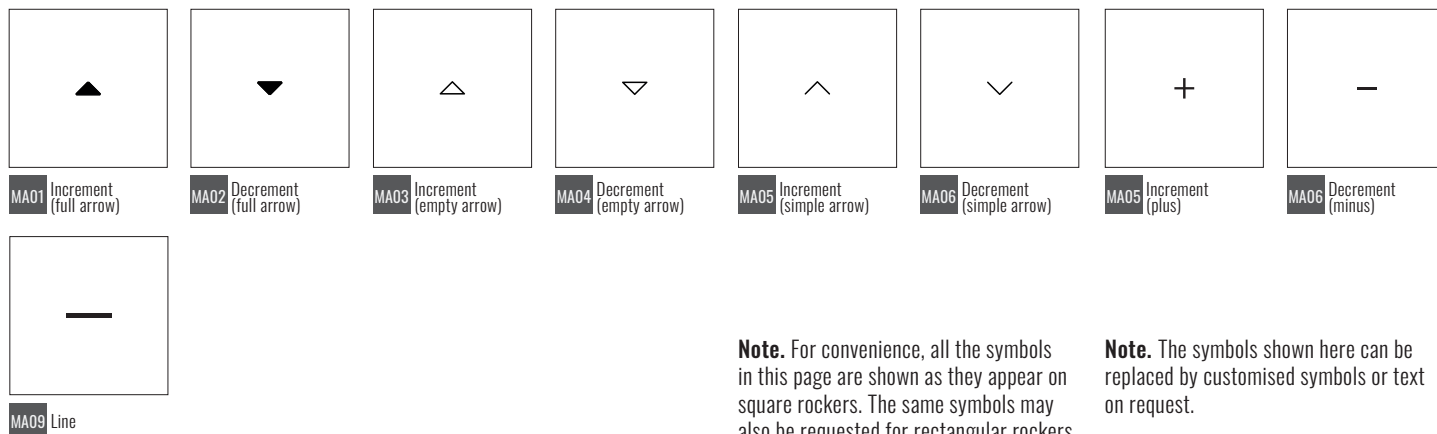

**Note.** For convenience, all the symbols in this page are shown as they appear on square rockers. The same symbols may also be requested for rectangular rockers.

**Note.** The symbols shown here can be replaced by customised symbols or text on request.

## Double symbols

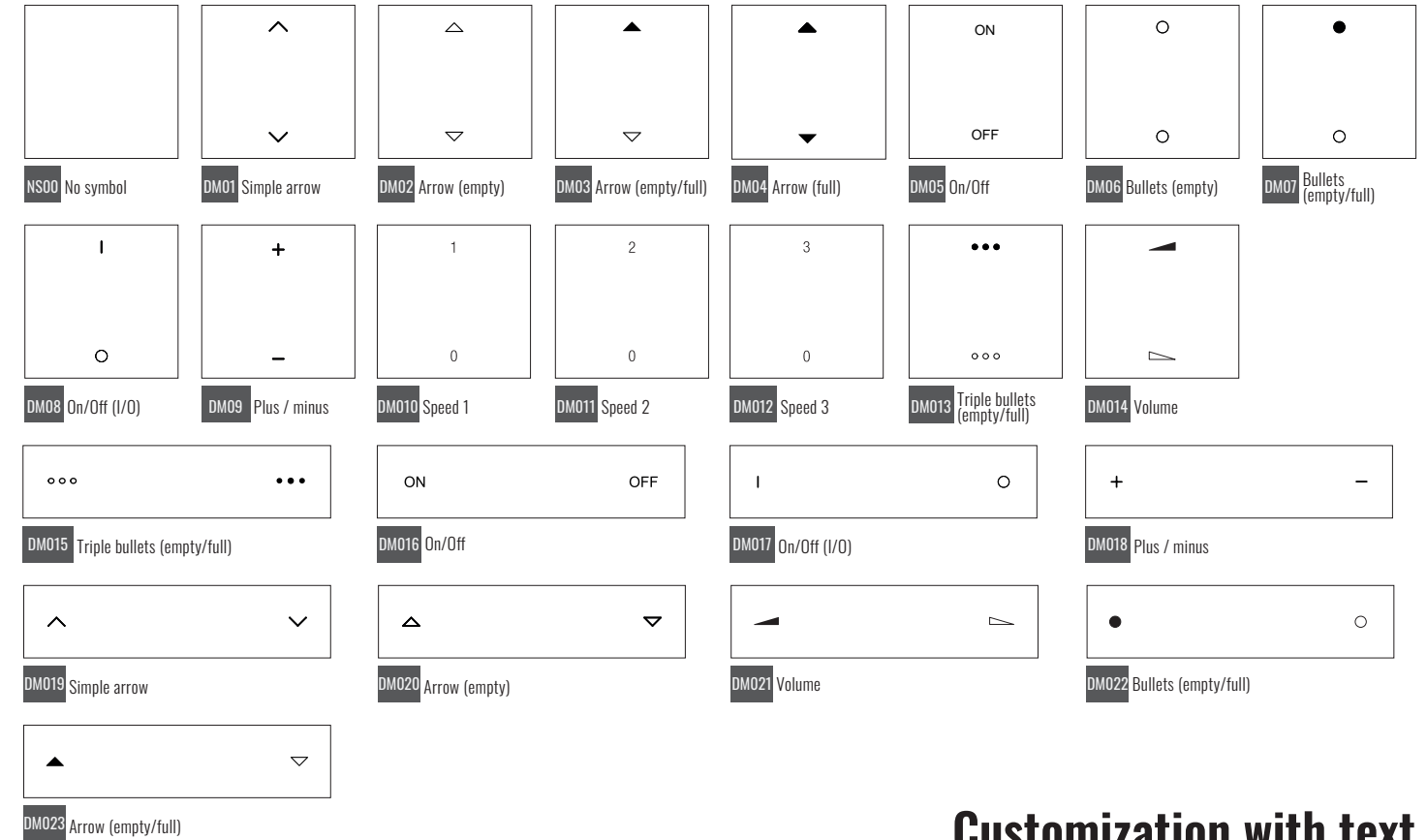

## Customization with text

WALL-MOUNT DEVICES

Square rockers can be customized with text to be shown in the upper, central or lower areas. Texts must be specified at order time.

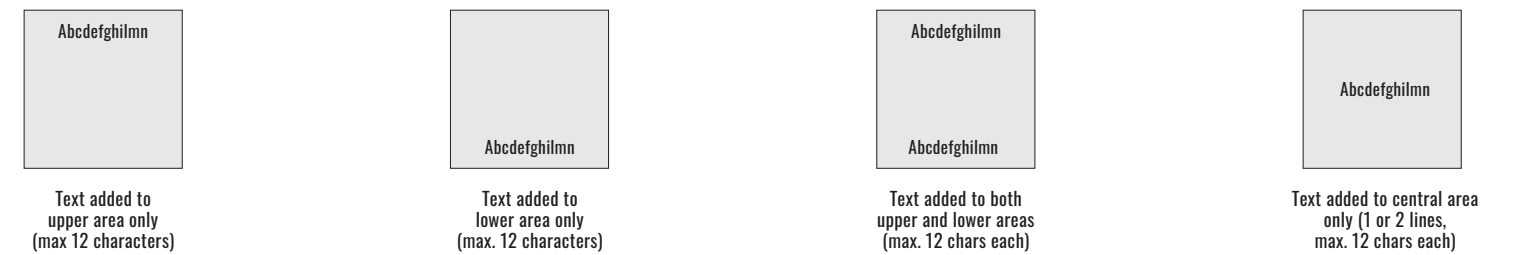

Horizontal rectangular rockers can be customized by means of text in their central area.

Vertical rectangular rockers can be customized with text to be shown in the upper, central or lower areas.

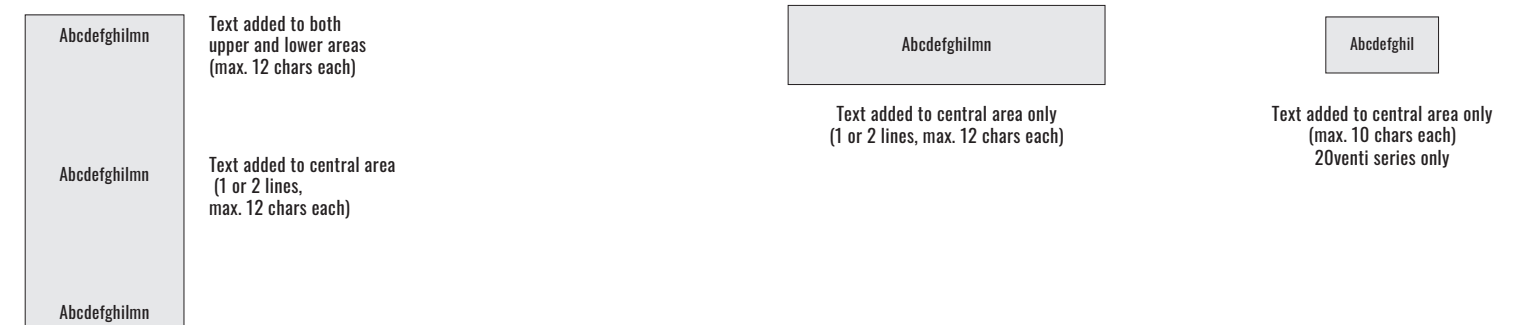

# Rockers for pushbuttons 20venti series

WALL-MOUNT DEVICES

## Rockers for 4-fold pushbutton 20venti series.

The ordering code of a rocker is formed by a fixed part (EK-T) plus a variable part which represents modularity, material, colour, finishing and customization codes as shown in symbol library.

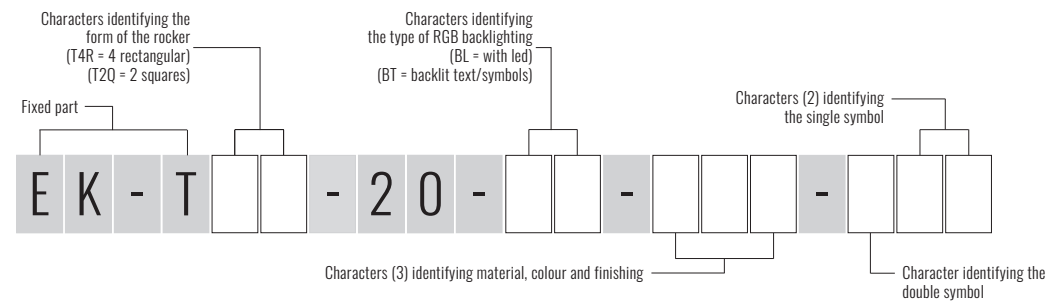

### PLASTIC MATERIAL

Modularity	Colour	Finishing	Code
 rectangular backlit text/symbols (4 rockers 30 x 15 mm)	white	normal	EK-T4R-20-BT-GAA
	fire white	normal*	EK-T4R-20-BT-GAC
	intense black RAL 9005	normal	EK-T4R-20-BT-GAE
	silver	normal	EK-T4R-20-BT-GAG
	hematite	normal*	EK-T4R-20-BT-GAI
	graphite	normal*	EK-T4R-20-BT-GAL

\*) Version on request

# Rockers for pushbuttons FF series

WALL-MOUNT DEVICES

## Rockers for 4-fold pushbutton 71 series.

The ordering code of a rocker is formed by a fixed part (EK-T) plus a variable part which represents modularity, material, colour, finishing and customization codes as shown in symbol library.

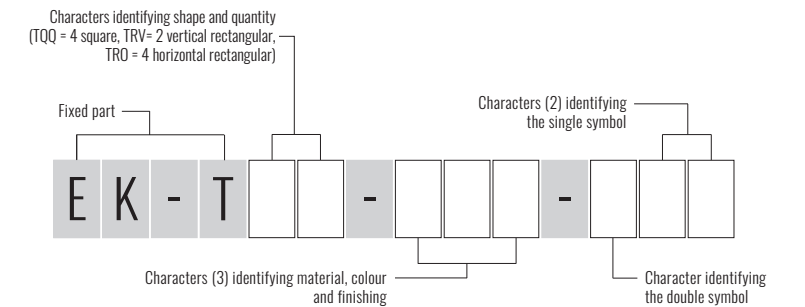

### ALUMINIUM

Modularity	Colour	Finishing	Code
 square	aluminium		EK-TQQ-GBQ
	nickel		EK-TQQ-GBR
	titanium		EK-TQQ-GBS
	carbon		EK-TQQ-GBU
	brass		EK-TQQ-GBB
	aluminium	brushed	
 rectangular (vertical)	nickel		EK-TRV-GBR
	titanium		EK-TRV-GBS
	carbon		EK-TRV-GBU
	brass		EK-TRV-GBB
 rectangular (horizontal)	aluminium		EK-TRO-GBQ
	nickel		EK-TRO-GBR
	titanium		EK-TRO-GBS
	carbon		EK-TRO-GBU
	brass		EK-TRO-GBB

### FENIX NTM®

Modularity	Colour	Code
 square	malè white	EK-TQQ-FBM
	beige luxor	EK-TQQ-FBL
	beaver ottawa	EK-TQQ-FCO
	cocoa orinoco	EK-TQQ-FCC
	grey efeso	EK-TQQ-FGE
	grey london	EK-TQQ-FGL
	grey bromine	EK-TQQ-FGB
	green commodore	EK-TQQ-FVC
	black ingo	EK-TQQ-FNI
	 rectangular verticale	malè white
beige luxor		EK-TRV-FBL
beaver ottawa		EK-TRV-FCO
cocoa orinoco		EK-TRV-FCC
grey efeso		EK-TRV-FGE
grey london		EK-TRV-FGL
grey bromine		EK-TRV-FGB
green commodore		EK-TRV-FVC
black ingo		EK-TRV-FNI
 rectangular orizzontale		malè white
	beige luxor	EK-TRO-FBL
	beaver ottawa	EK-TRO-FCO
	cocoa orinoco	EK-TRO-FCC
	grey efeso	EK-TRO-FGE
	grey london	EK-TRO-FGL
	grey bromine	EK-TRO-FGB
	green commodore	EK-TRO-FVC
	black ingo	EK-TRO-FNI

### PLASTIC MATERIAL

Modularity	Colour	Finishing	Code
 square	white	normal	EK-TQQ-GAA
	ice white	soft-touch*	EK-TQQ-GAB
	fire white	normal*	EK-TQQ-GAC
		soft-touch*	EK-TQQ-GAD
	intense black RAL 9005	normal	EK-TQQ-GAE
		soft-touch*	EK-TQQ-GAF
	silver	normal	EK-TQQ-GAG
	hematite	normal*	EK-TQQ-GAI
	graphite	normal*	EK-TQQ-GAL
	 rectangular (vertical)	white	normal
ice white		soft-touch*	EK-TRV-GAB
fire white		normal*	EK-TRV-GAC
		soft-touch*	EK-TRV-GAD
intense black RAL 9005		normal	EK-TRV-GAE
		soft-touch*	EK-TRV-GAF
silver		normal	EK-TRV-GAG
hematite		normal*	EK-TRV-GAI
graphite		normal*	EK-TRV-GAL
 rectangular (horizontal)		white	normal
	ice white	soft-touch*	EK-TRO-GAB
	fire white	normal*	EK-TRO-GAC
		soft-touch*	EK-TRO-GAD
	intense black RAL 9005	normal	EK-TRO-GAE
		soft-touch*	EK-TRO-GAF
	silver	normal	EK-TRO-GAG
	hematite	normal*	EK-TRO-GAI
	graphite	normal*	EK-TRO-GAL

\*) Version on request



# Kit 2 rockers for room thermostats FF series

WALL-MOUNT DEVICES

## PLASTIC MATERIAL

Modularity	Colour	Finishing	Code
 square	white	normal	EK-TQQ-GAA-EP2
	ice white	soft-touch*	EK-TQQ-GAB-EP2
	fire white	normal*	EK-TQQ-GAC-EP2
		soft-touch*	EK-TQQ-GAD-EP2
	intense black RAL 9005	normal	EK-TQQ-GAE-EP2
		soft-touch*	EK-TQQ-GAF-EP2
	silver	normal	EK-TQQ-GAG-EP2
	hematite	normal*	EK-TQQ-GAI-EP2
	graphite	normal*	EK-TQQ-GAL-EP2

\*) Version on request  
Note. The kit includes 2 rockers customized with symbols for the control of thermostats functions.

## ALUMINIUM

Modularity	Colour	Finishing	Code
 square	aluminium		EK-TQQ-GBQ-EP2
	nickel		EK-TQQ-GBR-EP2
	titanium	brushed	EK-TQQ-GBS-EP2
	carbon		EK-TQQ-GBU-EP2
	brass		EK-TQQ-GBB-EP2



Note. The kit includes 2 rockers customized with symbols for the control of thermostats functions.

## FENIX NTM®

Modularity	Colour	Code
 square	malè white	EK-TQQ-FBM-EP2
	beige luxor	EK-TQQ-FBL-EP2
	beaver ottawa	EK-TQQ-FCO-EP2
	cocoa orinoco	EK-TQQ-FCC-EP2
	grey efeso	EK-TQQ-FGE-EP2
	grey london	EK-TQQ-FGL-EP2
	grey bromine	EK-TQQ-FGB-EP2
	green commodore	EK-TQQ-FVC-EP2





Note. The kit includes 2 rockers customized with symbols for the control of thermostats functions.

## PLASTIC MATERIAL





Modularity	Colour	Finishing	Code
 square (4 rockers 30 x 30 mm)	white	normal	EK-T4Q-GAA
	ice white	soft-touch*	EK-T4Q-GAB
	fire white	normal*	EK-T4Q-GAC
		soft-touch*	EK-T4Q-GAD
	intense black RAL 9005	normal	EK-T4Q-GAE
	soft-touch*	EK-T4Q-GAF	
	silver	normal	EK-T4Q-GAG
	hematite	normal*	EK-T4Q-GAI
	graphite	normal*	EK-T4Q-GAL
	 rectangular horizontal (4 rockers 60 x 15 mm)	white	normal
ice white		soft-touch*	EK-T4R-GAB
fire white		normal*	EK-T4R-GAC
		soft-touch*	EK-T4R-GAD
intense black RAL 9005		normal	EK-T4R-GAE
soft-touch*		EK-T4R-GAF	
silver		normal	EK-T4R-GAG
hematite		normal*	EK-T4R-GAI
graphite		normal*	EK-T4R-GAL
 ET2 or ES2 frontal cover (60 x 60 mm)		white	normal
	ice white	soft-touch*	EK-T1Q-GAB-ET2
	fire white	normal*	EK-T1Q-GAC-ET2
		soft-touch*	EK-T1Q-GAD-ET2
	intense black RAL 9005	normal	EK-T1Q-GAE-ET2
	soft-touch*	EK-T1Q-GAF-ET2	
	silver	normal	EK-T1Q-GAG-ET2
	hematite	normal*	EK-T1Q-GAI-ET2
	graphite	normal*	EK-T1Q-GAL-ET2

\*) Version on request

## ALUMINIUM

Modularity	Colour	Finishing	Code
 square (1 rocker 60 x 60 mm)	aluminium		EK-T1Q-GBQ
	nickel		EK-T1Q-GBR
	titanium		EK-T1Q-GBS
	carbon		EK-T1Q-GBU
	brass		EK-T1Q-GBB
 rectangular vertical (2 rockers 30 x 60 mm)	aluminium		EK-T2R-GBQ
	nickel		EK-T2R-GBR
	titanium		EK-T2R-GBS
	carbon		EK-T2R-GBU
	brass		EK-T2R-GBB
 square (4 rockers 30 x 30 mm)	aluminium		EK-T4Q-GBQ
	nickel		EK-T4Q-GBR
	titanium	brushed	EK-T4Q-GBS
	carbon		EK-T4Q-GBU
	brass		EK-T4Q-GBB
 rectangular horizontal (4 rockers 60 x 15 mm)	aluminium		EK-T4R-GBQ
	nickel		EK-T4R-GBR
	titanium		EK-T4R-GBS
	carbon		EK-T4R-GBU
	brass		EK-T4R-GBB
 ET2 or ES2 frontal cover (60 x 60 mm)	aluminium		EK-T1Q-GBQ-ET2
	nickel		EK-T1Q-GBR-ET2
	titanium		EK-T1Q-GBS-ET2
	carbon		EK-T1Q-GBU-ET2
	brass		EK-T1Q-GBB-ET2

## FENIX NTM®

Modularity	Colour	Code
 square (1 rocker 60 x 60 mm)	malè white	EK-T1Q-FBM
	beige luxor	EK-T1Q-FBL
	beaver ottawa	EK-T1Q-FCO
	cocoa orinoco	EK-T1Q-FCC
	grey efeso	EK-T1Q-FGE
	grey london	EK-T1Q-FGL
	grey bromine	EK-T1Q-FGB
	green commodore	EK-T1Q-FVC
	black ingo	EK-T1Q-FNI
	 rectangular vertical (2 rockers 30 x 60 mm)	malè white
beige luxor		EK-T2R-FBL
beaver ottawa		EK-T2R-FCO
cocoa orinoco		EK-T2R-FCC
grey efeso		EK-T2R-FGE
grey london		EK-T2R-FGL
grey bromine		EK-T2R-FGB
green commodore		EK-T2R-FVC
black ingo		EK-T2R-FNI
 square (4 rockers 30 x 30 mm)		malè white
	beige luxor	EK-T4Q-FBL
	beaver ottawa	EK-T4Q-FCO
	cocoa orinoco	EK-T4Q-FCC
	grey efeso	EK-T4Q-FGE
	grey london	EK-T4Q-FGL
	grey bromine	EK-T4Q-FGB
	green commodore	EK-T4Q-FVC
	black ingo	EK-T4Q-FNI
	 rectangular horizontal (4 rockers 60 x 15 mm)	malè white
beige luxor		EK-T4R-FBL
beaver ottawa		EK-T4R-FCO
cocoa orinoco		EK-T4R-FCC
grey efeso		EK-T4R-FGE
grey london		EK-T4R-FGL
grey bromine		EK-T4R-FGB
green commodore		EK-T4R-FVC
black ingo		EK-T4R-FNI
 ET2 or ES2 frontal cover (60 x 60 mm)		malè white
	beige luxor	EK-T1Q-FBL-ET2
	beaver ottawa	EK-T1Q-FCO-ET2
	cocoa orinoco	EK-T1Q-FCC-ET2
	grey efeso	EK-T1Q-FGE-ET2
	grey london	EK-T1Q-FGL-ET2
	grey bromine	EK-T1Q-FGB-ET2
	green commodore	EK-T1Q-FVC-ET2
	black ingo	EK-T1Q-FNI-ET2

# Rockers - codes for pushbuttons 71 series



WALL-MOUNT DEVICES

## Rockers for 4-fold pushbutton 71 series.

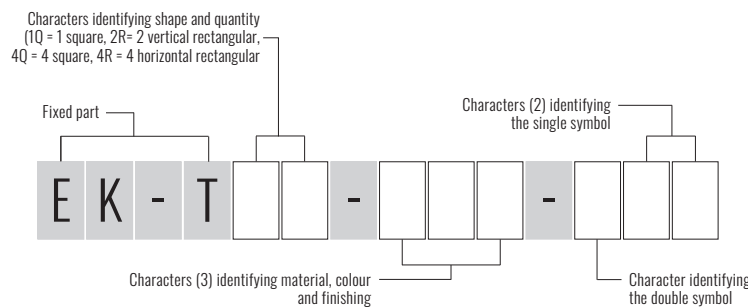
The ordering code of a rocker is formed by a fixed part (EK-T) plus a variable part which represents modularity, material, colour, finishing and customization codes as shown in symbol library.



## PLASTIC MATERIAL

Modularity	Colour	Finishing	Code
 square (1 rocker 60 x 60 mm)	white	normal	EK-T1Q-GAA
	ice white	soft-touch*	EK-T1Q-GAB
	fire white	normal*	EK-T1Q-GAC
		soft-touch*	EK-T1Q-GAD
	intense black RAL 9005	normal	EK-T1Q-GAE
	soft-touch*	EK-T1Q-GAF	
	silver	normal	EK-T1Q-GAG
	hematite	normal*	EK-T1Q-GAI
	graphite	normal*	EK-T1Q-GAL
	 rectangular vertical (2 rockers 30 x 60 mm)	white	normal
ice white		soft-touch*	EK-T2R-GAB
fire white		normal*	EK-T2R-GAC
		soft-touch*	EK-T2R-GAD
intense black RAL 9005		normal	EK-T2R-GAE
soft-touch*		EK-T2R-GAF	
silver		normal	EK-T2R-GAG
hematite		normal*	EK-T2R-GAI
graphite		normal*	EK-T2R-GAL

\*) Version on request

## Power sockets cover

WALL-MOUNT DEVICES

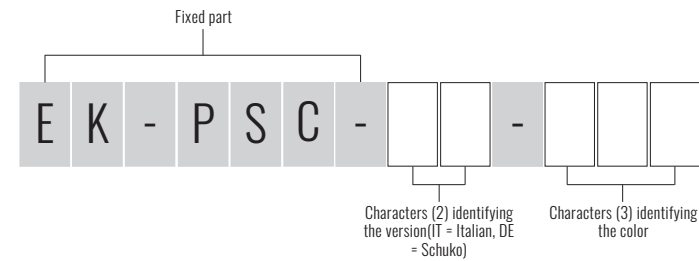

### Power socket - Italian and Schuko version

The ordering code for the coloured cover of an electrical socket is formed by a fixed part (EK-PSC) and a variable part depending on the version (Italian or Schuko) and the colour. The ordering code for the electrical socket body only is EK-PWS-. (IT or DE).

#### PLASTIC MATERIAL

Version	Dimensions	Color	Finishing	Code
Italian		white	normal	EK-PSC-IT-GAA
		intense black	normal	EK-PSC-IT-GAE
		silver	normal	EK-PSC-IT-GAG

#### PLASTIC MATERIAL

Version	Dimensions	Color	Finishing	Code
Schuko		white	normal	EK-PSC-DE-GAA
		intense black	norma	EK-PSC-DE-GAE
		silver	normal	EK-PSC-DE-GAG

#### ALUMINIUM-EFFECT PAINTING

Version	Dimensions	Color	Code
Italian		aluminium	EK-PSC-IT-GBQ
		nickel	EK-PSC-IT-GBR
		titanium	EK-PSC-IT-GBS
		carbon	EK-PSC-IT-GBU
		brass	EK-PSC-IT-GBB

#### ALUMINIUM-EFFECT PAINTING

Version	Dimensions	Color	Code
Schuko		aluminium	EK-PSC-DE-GBQ
		nickel	EK-PSC-DE-GBR
		titanium	EK-PSC-DE-GBS
		carbon	EK-PSC-DE-GBU
		brass	EK-PSC-DE-GBB

#### FENIX NTM®-EFFECT PAINTING

Version	Dimensions	Color	Code
Italian		malè white	EK-PSC-IT-FBM
		beige luxor	EK-PSC-IT-FBL
		beaver ottawa	EK-PSC-IT-FCO
		cocoa orinoco	EK-PSC-IT-FCC
		grey efeso	EK-PSC-IT-FGE
		grey london	EK-PSC-IT-FGL
		grey bromine	EK-PSC-IT-FGB
		green commodore	EK-PSC-IT-FVC
		black ingo	EK-PSC-IT-FNI

#### FENIX NTM®-EFFECT PAINTING

Version	Dimensions	Color	Code
Schuko		malè white	EK-PSC-DE-FBM
		beige luxor	EK-PSC-DE-FBL
		beaver ottawa	EK-PSC-DE-FCO
		cocoa orinoco	EK-PSC-DE-FCC
		grey efeso	EK-PSC-DE-FGE
		grey london	EK-PSC-DE-FGL
		grey bromine	EK-PSC-DE-FGB
		green commodore	EK-PSC-DE-FVC
		black ingo	EK-PSC-DE-FNI

## Power sockets USB cover

WALL-MOUNT DEVICES

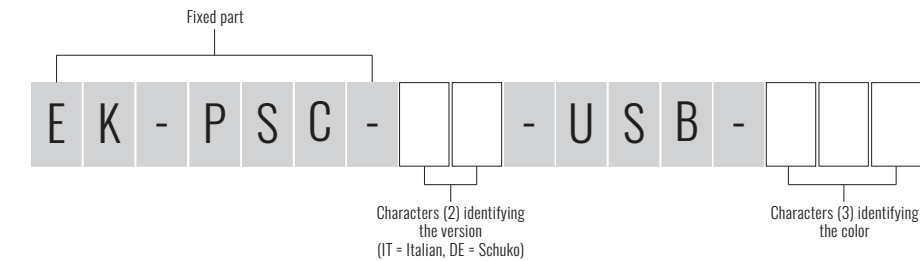

### Power socket USB - Italian and Schuko version

The ordering code for the coloured cover of an electrical socket is formed by a fixed part (EK-PSC) and a variable part depending on the version (Italian or Schuko) and the colour. The ordering code for the USB power socket body only is EK-PWS-.-USB (EN or DE).

#### PLASTIC MATERIAL

Version	Dimensions	Color	Finishing	Code
Italian		white	normal	EK-PSC-IT-USB-GAA
		intense black	normal	EK-PSC-IT-USB-GAE
		silver	normal	EK-PSC-IT-USB-GAG

#### PLASTIC MATERIAL

Version	Dimensions	Color	Finishing	Code
Schuko		white	normal	EK-PSC-DE-USB-GAA
		intense black	normal	EK-PSC-DE-USB-GAE
		silver	normal	EK-PSC-DE-USB-GAG

#### ALUMINIUM-EFFECT PAINTING

Version	Dimensions	Color	Code
Italian		aluminium	EK-PSC-IT-USB-GBQ
		nickel	EK-PSC-IT-USB-GBR
		titanium	EK-PSC-IT-USB-GBS
		carbon	EK-PSC-IT-USB-GBU
		brass	EK-PSC-IT-USB-GBB

#### ALUMINIUM-EFFECT PAINTING

Version	Dimensions	Color	Code
Schuko		aluminium	EK-PSC-DE-USB-GBQ
		nickel	EK-PSC-DE-USB-GBR
		titanium	EK-PSC-DE-USB-GBS
		carbon	EK-PSC-DE-USB-GBU
		brass	EK-PSC-DE-USB-GBB

#### FENIX NTM®-EFFECT PAINTING

Version	Dimensions	Color	Code
Italian		malè white	EK-PSC-IT-USB-FBM
		beige luxor	EK-PSC-IT-USB-FBL
		beaver ottawa	EK-PSC-IT-USB-FCO
		cocoa orinoco	EK-PSC-IT-USB-FCC
		grey efeso	EK-PSC-IT-USB-FGE
		grey london	EK-PSC-IT-USB-FGL
		grey bromine	EK-PSC-IT-USB-FGB
		green commodore	EK-PSC-IT-USB-FVC
		black ingo	EK-PSC-IT-USB-FNI

#### FENIX NTM®-EFFECT PAINTING

Version	Dimensions	Color	Code
Schuko		malè white	EK-PSC-DE-USB-FBM
		beige luxor	EK-PSC-DE-USB-FBL
		beaver ottawa	EK-PSC-DE-USB-FCO
		cocoa orinoco	EK-PSC-DE-USB-FCC
		grey efeso	EK-PSC-DE-USB-FGE
		grey london	EK-PSC-DE-USB-FGL
		grey bromine	EK-PSC-DE-USB-FGB
		green commodore	EK-PSC-DE-USB-FVC
		black ingo	EK-PSC-DE-USB-FNI



## How to order a frame

WALL-MOUNT DEVICES

### Form and Flank frames for devices of FF and 71 series.

The ordering number of a frame includes a fixed part (EK-) and a variable part which depends on the series (Form or Flank), shape (square, rectangular or double), material, colour and finishing.

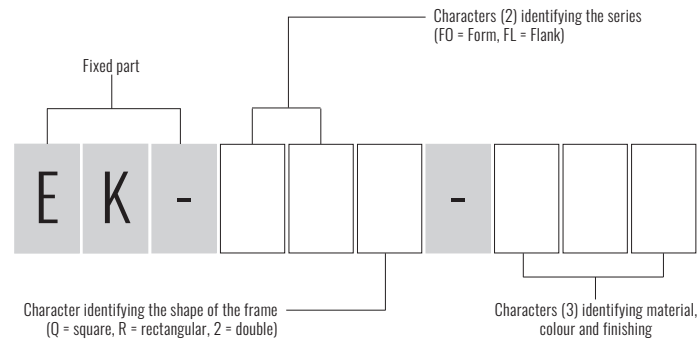

## Frame codes - Form series

WALL-MOUNT DEVICES

### PLASTIC MATERIAL

Series	Modularity	Colour	Finishing	Code
FF - 71	square	white	normal	EK-FOQ-GAA
		ice white	soft-touch *	EK-FOQ-GAB
		fire white	normal *	EK-FOQ-GAC
			soft-touch *	EK-FOQ-GAD
		intense black RAL 9005	normal	EK-FOQ-GAE
			soft-touch *	EK-FOQ-GAF
	rectangular	silver	normal	EK-FOQ-GAG
		hematite	normal *	EK-FOQ-GAI
		graphite	normal *	EK-FOQ-GAL
		white	normal	EK-FOR-GAA
		ice white	soft-touch *	EK-FOR-GAB
		fire white	normal *	EK-FOR-GAC
	soft-touch *	EK-FOR-GAD		
double	intense black RAL 9005	normal	EK-FOR-GAE	
		soft-touch *	EK-FOR-GAF	
	silver	normal	EK-FOR-GAG	
	hematite	normal *	EK-FOR-GAI	
	graphite	normal *	EK-FOR-GAL	
	white	normal	EK-FO2-GAA	
	soft-touch *	EK-FO2-GAE		
	normal *	EK-FO2-GAG		
	soft-touch *	EK-FO2-GAA		
	normal	EK-FO2-GAB		
	soft-touch *	EK-FO2-GAC		
	normal	EK-FO2-GAD		
	normal *	EK-FO2-GAE		
	normal *	EK-FO2-GAF		

\*) Version on request

### ALUMINIUM

Series	Modularity	Colour	Finishing	Code
FF - 71	square	aluminium		EK-FOQ-GBQ
		nickel		EK-FOQ-GBR
		titanium		EK-FOQ-GBS
		carbon		EK-FOQ-GBU
		brass		EK-FOQ-GBB
		aluminium		EK-FOR-GBQ
	rectangular	nickel	brushed	EK-FOR-GBR
		titanium		EK-FOR-GBS
		carbon		EK-FOR-GBU
		brass		EK-FOR-GBB
		aluminium		EK-FO2-GBQ
		nickel		EK-FO2-GBR
	double	titanium		EK-FO2-GBS
		carbon		EK-FO2-GBU
		brass		EK-FO2-GBB

## Frame codes - Flank series

WALL-MOUNT DEVICES

### ALUMINIUM

Series	Modularity	Colour	Finishing	Code
FF - 71	square	aluminium		EK-FLQ-GBQ
		nickel		EK-FLQ-GBR
		titanium		EK-FLQ-GBS
		carbon		EK-FLQ-GBU
		brass		EK-FLQ-GBB
		aluminium		EK-FLR-GBQ
	rectangular	nickel	brushed	EK-FLR-GBR
		titanium		EK-FLR-GBS
		carbon		EK-FLR-GBU
		brass		EK-FLR-GBB
		aluminium		EK-FL2-GBQ
		nickel		EK-FL2-GBR
	double	titanium		EK-FL2-GBS
		carbon		EK-FL2-GBU
		brass		EK-FL2-GBB

### PLASTIC MATERIAL

Series	Modularity	Colour	Finishing	Code
FF - 71	square	white	normal	EK-FLQ-GAA
		ice white	soft-touch *	EK-FLQ-GAB
		fire white	normal *	EK-FLQ-GAC
			soft-touch *	EK-FLQ-GAD
		intense black RAL 9005	normal	EK-FLQ-GAE
			soft-touch *	EK-FLQ-GAF
	rectangular	silver	normal	EK-FLQ-GAG
		hematite	normal *	EK-FLQ-GAI
		graphite	normal *	EK-FLQ-GAL
		white	normal	EK-FLR-GAA
		ice white	soft-touch *	EK-FLR-GAB
		fire white	normal *	EK-FLR-GAC
		soft-touch *	EK-FLR-GAD	
	double	intense black RAL 9005	normal	EK-FLR-GAE
			soft-touch *	EK-FLR-GAF
		silver	normal	EK-FLR-GAG
		hematite	normal *	EK-FLR-GAI
		graphite	normal *	EK-FLR-GAL
		white	normal	EK-FL2-GAA
		soft-touch *	EK-FL2-GAB	
		normal *	EK-FL2-GAC	
		soft-touch *	EK-FL2-GAD	
		normal	EK-FL2-GAE	
		soft-touch *	EK-FL2-GAF	
	normal	EK-FL2-GAG		
	normal *	EK-FL2-GAI		
	normal *	EK-FL2-GAL		

\*) Version on request

## How to order a plate

WALL-MOUNT DEVICES

### Plates for devices of 71 series and flush-mounting inserts (FF and 71).

The ordering code of a plate consists of a fixed part (EK-P) and a variable part depending on shape (square or rectangular), window size (small or large), material, colour and finishing.

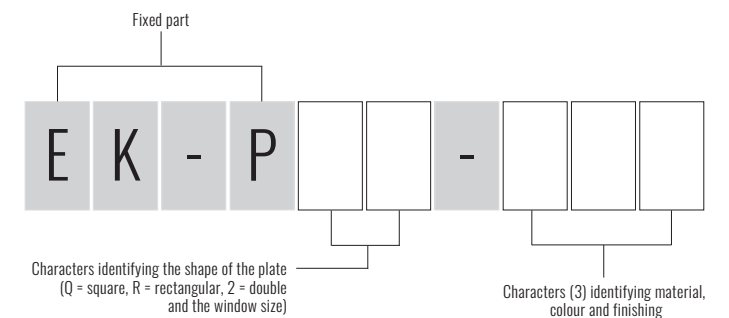

# Square plate

WALL-MOUNT DEVICES

## PLASTIC MATERIAL

Series	Window	Colour	Finishing	Code
FF - 71	45 x 45 mm	white	normal	EK-PQP-GAA
		ice white	soft-touch *	EK-PQP-GAB
		fire white	normal *	EK-PQP-GAC
			soft-touch *	EK-PQP-GAD
		intense black RAL 9005	normal	EK-PQP-GAE
			soft-touch *	EK-PQP-GAF
	55 x 55 mm	silver	normal	EK-PQP-GAG
		hematite	normal *	EK-PQP-GAI
		graphite	normal *	EK-PQP-GAL
		white	normal	EK-PQG-GAA
		ice white	soft-touch *	EK-PQG-GAB
		fire white	normal *	EK-PQG-GAC
soft-touch *	EK-PQG-GAD			
60 x 60 mm	intense black RAL 9005	normal	EK-PQG-GAE	
		soft-touch *	EK-PQG-GAF	
	silver	normal	EK-PQG-GAG	
	hematite	normal *	EK-PQG-GAI	
	graphite	normal *	EK-PQG-GAL	
	white	normal	EK-PQS-GAA	
ice white	soft-touch *	EK-PQS-GAB		
fire white	normal *	EK-PQS-GAC		
	soft-touch *	EK-PQS-GAD		
intense black RAL 9005	normal	EK-PQS-GAE		
	soft-touch *	EK-PQS-GAF		
silver	normal	EK-PQS-GAG		
hematite	normal *	EK-PQS-GAI		
graphite	normal *	EK-PQS-GAL		

\*) Version on request

## ALUMINIUM

Series	Modularity	Colour	Finishing	Code
FF - 71	45 x 45 mm	aluminium	brushed	EK-PQP-GBQ
		nickel		EK-PQP-GBR
		titanium		EK-PQP-GBS
		carbon		EK-PQP-GBU
		brass		EK-PQP-GBB
		aluminium		EK-PQG-GBQ
	55 x 55 mm	nickel	EK-PQG-GBR	
		titanium	EK-PQG-GBS	
		carbon	EK-PQG-GBU	
		brass	EK-PQG-GBB	
		aluminium	EK-PQS-GBQ	
		nickel	EK-PQS-GBR	
	60 x 60 mm	titanium	EK-PQS-GBS	
		carbon	EK-PQS-GBU	
		brass	EK-PQS-GBB	

## FENIX NTM®

Series	Window	Colour	Code
FF - 71	45 x 45 mm	malè white	EK-PQP-FBM
		beige luxor	EK-PQP-FBL
		beaver ottawa	EK-PQP-FCO
		cocoa orinoco	EK-PQP-FCC
		grey efeso	EK-PQP-FGE
		grey london	EK-PQP-FGL
		grey bromine	EK-PQP-FGB
		green commodore	EK-PQP-FVC
		black ingo	EK-PQP-FNI
		malè white	EK-PQG-FBM
		beige luxor	EK-PQG-FBL
		beaver ottawa	EK-PQG-FCO
	55 x 55 mm	cocoa orinoco	EK-PQG-FCC
		grey efeso	EK-PQG-FGE
		grey london	EK-PQG-FGL
		grey bromine	EK-PQG-FGB
		green commodore	EK-PQG-FVC
		black ingo	EK-PQG-FNI
		malè white	EK-PQS-FBM
		beige luxor	EK-PQS-FBL
		beaver ottawa	EK-PQS-FCO
		cocoa orinoco	EK-PQS-FCC
		grey efeso	EK-PQS-FGE
		60 x 60 mm	grey london
	grey bromine		EK-PQS-FGB
	green commodore		EK-PQS-FVC
	black ingo		EK-PQS-FNI

# Rectangular plate

WALL-MOUNT DEVICES

## PLASTIC MATERIAL

Series	Window	Colour	Finishing	Code
FF - 71	68 x 45 mm	white	normal	EK-PRG-GAA
		ice white	soft-touch *	EK-PRG-GAB
		fire white	normal *	EK-PRG-GAC
			soft-touch *	EK-PRG-GAD
		intense black RAL 9005	normal	EK-PRG-GAE
			soft-touch *	EK-PRG-GAF
	60 x 60 mm	silver	normal	EK-PRG-GAG
		hematite	normal *	EK-PRG-GAI
		graphite	normal *	EK-PRG-GAL
		white	normal	EK-PRS-GAA
		ice white	soft-touch *	EK-PRS-GAB
		fire white	normal *	EK-PRS-GAC
	soft-touch *		EK-PRS-GAD	
	intense black RAL 9005	normal	EK-PRS-GAE	
		soft-touch *	EK-PRS-GAF	
	silver	normal	EK-PRS-GAG	
	hematite	normal *	EK-PRS-GAI	
	graphite	normal *	EK-PRS-GAL	

\*) Version on request

## ALUMINIUM

Series	Window	Colour	Finishing	Code
FF - 71	68 x 45 mm	aluminium	brushed	EK-PRG-GBQ
		nickel		EK-PRG-GBR
		titanium		EK-PRG-GBS
		carbon		EK-PRG-GBU
		brass		EK-PRG-GBB
		aluminium		EK-PRS-GBQ
	60 x 60 mm	nickel	EK-PRS-GBR	
		titanium	EK-PRS-GBS	
		carbon	EK-PRS-GBU	
		brass	EK-PRS-GBB	

## FENIX NTM®

Series	Window	Colour	Code
FF - 71	66 x 44 mm	malè white	EK-PRP-FBM
		beige luxor	EK-PRP-FBL
		beaver ottawa	EK-PRP-FCO
		cocoa orinoco	EK-PRP-FCC
		grey efeso	EK-PRP-FGE
		grey london	EK-PRP-FGL
		grey bromine	EK-PRP-FGB
		green commodore	EK-PRP-FVC
		black ingo	EK-PRP-FNI
		malè white	EK-PRG-FBM
		beige luxor	EK-PRG-FBL
		beaver ottawa	EK-PRG-FCO
	68 x 45 mm	cocoa orinoco	EK-PRG-FCC
		grey efeso	EK-PRG-FGE
		grey london	EK-PRG-FGL
		grey bromine	EK-PRG-FGB
		green commodore	EK-PRG-FVC
		black ingo	EK-PRG-FNI
		malè white	EK-PRS-FBM
		beige luxor	EK-PRS-FBL
		beaver ottawa	EK-PRS-FCO
		cocoa orinoco	EK-PRS-FCC
		grey efeso	EK-PRS-FGE
		60 x 60 mm	grey london
	grey bromine		EK-PRS-FGB
	green commodore		EK-PRS-FVC
	black ingo		EK-PRS-FNI



# Double plate

WALL-MOUNT DEVICES

## PLASTIC MATERIAL

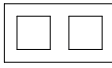
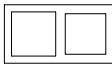
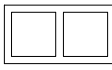
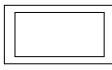
Series	Window	Colour	Finishing	Code
FF - 71	 55 x 55 mm (2)	white	normal	EK-P2P-GAA
		ice white	soft-touch *	EK-P2P-GAB
		fire white	normal *	EK-P2P-GAC
			soft-touch *	EK-P2P-GAD
		intense black RAL 9005	normal	EK-P2P-GAE
			soft-touch *	EK-P2P-GAF
	 55 x 55 mm (1) 60 x 60 mm (1)	silver	normal	EK-P2P-GAG
		hematite	normal *	EK-P2P-GAI
		graphite	normal *	EK-P2P-GAL
		white	normal	EK-P2G-GAA
		ice white	soft-touch *	EK-P2G-GAB
		fire white	normal *	EK-P2G-GAC
soft-touch *	EK-P2G-GAD			
FF - 71	 60 x 60 mm (2)	intense black RAL 9005	normal	EK-P2S-GAE
		silver	soft-touch *	EK-P2S-GAF
			normal	EK-P2S-GAG
		hematite	normal *	EK-P2S-GAI
		graphite	normal *	EK-P2S-GAL
		white	normal	EK-P2C-GAA
	 120 x 60 mm (1)	ice white	soft-touch *	EK-P2C-GAB
		fire white	normal *	EK-P2C-GAC
			soft-touch *	EK-P2C-GAD
		intense black RAL 9005	normal	EK-P2C-GAE
			soft-touch *	EK-P2C-GAF
		silver	normal	EK-P2C-GAG
hematite	normal *	EK-P2C-GAI		
graphite	normal *	EK-P2C-GAL		

\*) Version on request

## ALUMINIUM

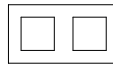
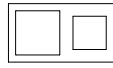
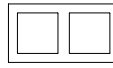
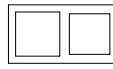
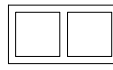
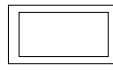
Series	Window	Colour	Finishing	Code
FF - 71	 45 x 45 mm (2)	aluminium	brushed	EK-P2E-GBQ
		nickel		EK-P2E-GBR
		titanium		EK-P2E-GBS
		carbon		EK-P2E-GBU
		brass		EK-P2E-GBB
		aluminium		EK-P2F-GBQ
	 45 x 45 mm (1) 60 x 60 mm (1)	nickel	EK-P2F-GBR	
		titanium	EK-P2F-GBS	
		carbon	EK-P2F-GBU	
		brass	EK-P2F-GBB	
		aluminium	EK-P2P-GBQ	
		nickel	EK-P2P-GBR	
FF - 71	 55 x 55 mm (2)	titanium	EK-P2P-GBS	
		carbon	EK-P2P-GBU	
		brass	EK-P2P-GBB	
		aluminium	EK-P2G-GBQ	
		nickel	EK-P2G-GBR	
		titanium	EK-P2G-GBS	
	 55 x 55 mm (1) 60 x 60 mm (1)	carbon	EK-P2G-GBU	
		brass	EK-P2G-GBB	
		aluminium	EK-P2S-GBQ	
		nickel	EK-P2S-GBR	
		titanium	EK-P2S-GBS	
		carbon	EK-P2S-GBU	
 60 x 60 mm (2)	brass	EK-P2S-GBB		
	aluminium	EK-P2C-GBQ		
	nickel	EK-P2C-GBR		
	titanium	EK-P2C-GBS		
	carbon	EK-P2C-GBU		
	brass	EK-P2C-GBB		
 120 x 60 mm (1)	aluminium	EK-P2C-GBQ		
	nickel	EK-P2C-GBR		
	titanium	EK-P2C-GBS		
	carbon	EK-P2C-GBU		
	brass	EK-P2C-GBB		

## FENIX NTM®

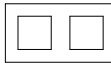
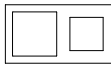
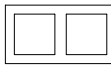
Series	Finestre	Colour	Code
FF - 71	 45 x 45 mm (2)	malè white	EK-P2F-FBM
		beige luxor	EK-P2F-FBL
		beaver ottawa	EK-P2F-FCO
		cocoa orinoco	EK-P2F-FCC
		grey efeso	EK-P2F-FGE
		grey london	EK-P2F-FGL
	 45 x 45 mm (1) 60 x 60 mm (1)	grey bromine	EK-P2F-FGB
		green commodore	EK-P2F-FVC
		black ingo	EK-P2F-FNI
		malè white	EK-P2F-FBM
		beige luxor	EK-P2F-FBL
		beaver ottawa	EK-P2F-FCO
 55 x 55 mm (2)	cocoa orinoco	EK-P2P-FCC	
	grey efeso	EK-P2P-FGE	
	grey london	EK-P2P-FGL	
	grey bromine	EK-P2P-FGB	
	green commodore	EK-P2P-FVC	
	black ingo	EK-P2P-FNI	

## FENIX NTM®

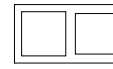
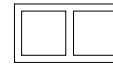
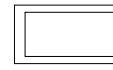
Series	Finestre	Colour	Code
FF - 71	 55 x 55 mm (1) 60 x 60 mm (1)	malè white	EK-P2G-FBM
		beige luxor	EK-P2G-FBL
		beaver ottawa	EK-P2G-FCO
		cocoa orinoco	EK-P2G-FCC
		grey efeso	EK-P2G-FGE
		grey london	EK-P2G-FGL
	 60 x 60 mm (2)	grey bromine	EK-P2S-FGB
		green commodore	EK-P2S-FVC
		black ingo	EK-P2S-FNI
		malè white	EK-P2S-FBM
		beige luxor	EK-P2S-FBL
		beaver ottawa	EK-P2S-FCO
 120 x 60 mm (1)	cocoa orinoco	EK-P2C-FCC	
	grey efeso	EK-P2C-FGE	
	grey london	EK-P2C-FGL	
	grey bromine	EK-P2C-FGB	
	green commodore	EK-P2C-FVC	
	black ingo	EK-P2C-FNI	

# How to order a Deep plate

WALL-MOUNT DEVICES

**Deep plates for devices of 20venti, 71 series and flush-mounting inserts (20venti, FF and 71).** The ordering code of a Deep plate consists of a fixed part (EK-D) and a variable part depending on shape (square or rectangular), window size (small or large), material, colour and finishing.

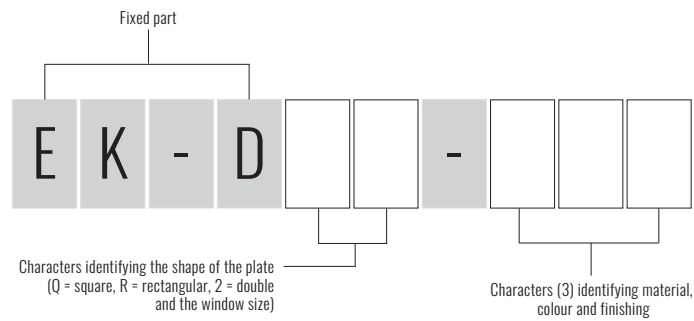

# Deep square plate

WALL-MOUNT DEVICES

## PLASTIC MATERIAL

Series	Window	Colour	Finishing	Code
20venti FF 71	45 x 45 mm	white	normal	EK-DQP-GAA
		ice white	soft-touch *	EK-DQP-GAB
		fire white	normal *	EK-DQP-GAC
			soft-touch *	EK-DQP-GAD
		intense black RAL 9005	normal	EK-DQP-GAE
			soft-touch *	EK-DQP-GAF
	55 x 55 mm	silver	normal	EK-DQP-GAG
		hematite	normal *	EK-DQP-GAI
		graphite	normal *	EK-DQP-GAL
		white	normal	EK-DQG-GAA
		ice white	soft-touch *	EK-DQG-GAB
		fire white	normal *	EK-DQG-GAC
	soft-touch *	EK-DQG-GAD		
60 x 60 mm	intense black RAL 9005	normal	EK-DQG-GAE	
		soft-touch *	EK-DQG-GAF	
	silver	normal	EK-DQS-GAG	
	hematite	normal *	EK-DQS-GAI	
	graphite	normal *	EK-DQS-GAL	

\*) Version on request

## ALUMINIUM

Series	Window	Colour	Finishing	Code
20venti (4 rockers)	30 x 60 mm	aluminium		EK-DQT-GBQ
		nickel		EK-DQT-GBR
		titanium		EK-DQT-GBS
		carbon		EK-DQT-GBU
				EK-DQT-GBB
				EK-DQP-GBQ
20venti FF 71	45 x 45 mm	aluminium	brushed	EK-DQP-GBQ
		nickel		EK-DQP-GBR
		titanium		EK-DQP-GBS
		carbon		EK-DQP-GBU
				EK-DQP-GBB
				EK-DQG-GBQ
20venti FF 71	55 x 55 mm	aluminium		EK-DQG-GBQ
		nickel		EK-DQG-GBR
		titanium		EK-DQG-GBS
		carbon		EK-DQG-GBU
				EK-DQG-GBB
				EK-DQS-GBQ
20venti FF 71	60 x 60 mm	aluminium		EK-DQS-GBQ
		nickel		EK-DQS-GBR
		titanium		EK-DQS-GBS
		carbon		EK-DQS-GBU
				EK-DQS-GBB
				EK-DQS-GBB

# Deep square plate

WALL-MOUNT DEVICES

## FENIX NTM®

Series	Window	Colour	Code
20venti (4 rockers)	30 x 60 mm	malè white	EK-DQT-FBM
		beige luxor	EK-DQT-FBL
		beaver ottawa	EK-DQT-FCO
		cocoa orinoco	EK-DQT-FCC
		grey efeso	EK-DQT-FGE
		grey london	EK-DQT-FGL
		grey bromine	EK-DQT-FGB
		green commodore	EK-DQT-FVC
		black ingo	EK-DQT-FNI
		malè white	EK-DQP-FBM
		beige luxor	EK-DQP-FBL
		20venti FF 71	45 x 45 mm
cocoa orinoco	EK-DQP-FCC		
grey efeso	EK-DQP-FGE		
grey london	EK-DQP-FGL		
grey bromine	EK-DQP-FGB		
green commodore	EK-DQP-FVC		
black ingo	EK-DQP-FNI		
malè white	EK-DQG-FBM		
beige luxor	EK-DQG-FBL		
beaver ottawa	EK-DQG-FCO		
cocoa orinoco	EK-DQG-FCC		
20venti FF 71	55 x 55 mm		
		grey london	EK-DQG-FGL
		grey bromine	EK-DQG-FGB
		green commodore	EK-DQG-FVC
		black ingo	EK-DQG-FNI
		malè white	EK-DQS-FBM
		beige luxor	EK-DQS-FBL
		beaver ottawa	EK-DQS-FCO
		cocoa orinoco	EK-DQS-FCC
		grey efeso	EK-DQS-FGE
		grey london	EK-DQS-FGL
		grey bromine	EK-DQS-FGB
20venti FF 71	60 x 60 mm	green commodore	EK-DQS-FVC
		black ingo	EK-DQS-FNI



# Deep rectangular plate

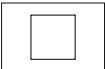

WALL-MOUNT DEVICES

## PLASTIC MATERIAL

Series	Window	Colour	Finishing	Code
20venti FF 71	 68 x 45 mm	white	normal	EK-DRG-GAA
		ice white	soft-touch *	EK-DRG-GAB
		fire white	normal *	EK-DRG-GAC
		fire white	soft-touch *	EK-DRG-GAD
		intense black RAL 9005	normal	EK-DRG-GAE
		intense black RAL 9005	soft-touch *	EK-DRG-GAF
		silver	normal	EK-DRG-GAG
		hematite	normal *	EK-DRG-GAI
		graphite	normal *	EK-DRG-GAL
	 60 x 60 mm	white	normal	EK-DRS-GAA
		ice white	soft-touch *	EK-DRS-GAB
		fire white	normal *	EK-DRS-GAC
		fire white	soft-touch *	EK-DRS-GAD
		intense black RAL 9005	normal	EK-DRS-GAE
		intense black RAL 9005	soft-touch *	EK-DRS-GAF
		silver	normal	EK-DRS-GAG
		hematite	normal *	EK-DRS-GAI
		graphite	normal *	EK-DRS-GAL

\*) Version on request



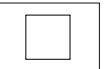

## ALUMINIUM

Series	Window	Colour	Finishing	Code
20venti FF 71	 68 x 45 mm	aluminium	brushed	EK-DRG-GBQ
		nickel		EK-DRG-GBR
		titanium		EK-DRG-GBS
		carbon		EK-DRG-GBU
		brass		EK-DRG-GBB
		aluminium		EK-DRS-GBQ
	 60 x 60 mm	nickel		EK-DRS-GBR
		titanium		EK-DRS-GBS
		carbon		EK-DRS-GBU
		brass		EK-DRS-GBB

## FENIX NTM®

Series	Window	Colour	Code
20venti FF 71	 68 x 45 mm	malè white	EK-DRG-FBM
		beige luxor	EK-DRG-FBL
		beaver ottawa	EK-DRG-FCO
		cocoa orinoco	EK-DRG-FCC
		grey efeso	EK-DRG-FGE
		grey london	EK-DRG-FGL
		grey bromine	EK-DRG-FGB
		green commodore	EK-DRG-FVC
		black ingo	EK-DRG-FNI
	 60 x 60 mm	malè white	EK-DRS-FBM
		beige luxor	EK-DRS-FBL
		beaver ottawa	EK-DRS-FCO
		cocoa orinoco	EK-DRS-FCC
		grey efeso	EK-DRS-FGE
		grey london	EK-DRS-FGL
		grey bromine	EK-DRS-FGB
		green commodore	EK-DRS-FVC
		black ingo	EK-DRS-FNI

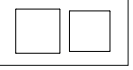
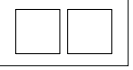
## PLASTIC MATERIAL



Series	Window	Colour	Finishing	Code
20venti FF 71	 55 x 55 mm (2)	white	normal	EK-D2P-GAA
		ice white	soft-touch *	EK-D2P-GAB
		fire white	normal *	EK-D2P-GAC
		fire white	soft-touch *	EK-D2P-GAD
		intense black RAL 9005	normal	EK-D2P-GAE
		intense black RAL 9005	soft-touch *	EK-D2P-GAF
		silver	normal	EK-D2P-GAG
		hematite	normal *	EK-D2P-GAI
		graphite	normal *	EK-D2P-GAL
	 45 x 45 mm (1) 60 x 60 mm (1)	white	normal	EK-D2F-GAA
		ice white	soft-touch *	EK-D2F-GAB
		fire white	normal *	EK-D2F-GAC
		fire white	soft-touch *	EK-D2F-GAD
		intense black RAL 9005	normal	EK-D2F-GAE
		intense black RAL 9005	soft-touch *	EK-D2F-GAF
		silver	normal	EK-D2F-GAG
		hematite	normal *	EK-D2F-GAI
		graphite	normal *	EK-D2F-GAL
20venti FF 71	 55 x 55 mm (1) 60 x 60 mm (1)	white	normal	EK-D2G-GAA
		ice white	soft-touch *	EK-D2G-GAB
		fire white	normal *	EK-D2G-GAC
		fire white	soft-touch *	EK-D2G-GAD
		intense black RAL 9005	normal	EK-D2G-GAE
		intense black RAL 9005	soft-touch *	EK-D2G-GAF
		silver	normal	EK-D2G-GAG
		hematite	normal *	EK-D2G-GAI
		graphite	normal *	EK-D2G-GAL
	 60 x 60 mm (2)	white	normal	EK-D2S-GAA
		ice white	soft-touch *	EK-D2S-GAB
		fire white	normal *	EK-D2S-GAC
		fire white	soft-touch *	EK-D2S-GAD
		intense black RAL 9005	normal	EK-D2S-GAE
		intense black RAL 9005	soft-touch *	EK-D2S-GAF
		silver	normal	EK-D2S-GAG
		hematite	normal *	EK-D2S-GAI
		graphite	normal *	EK-D2S-GAL
 120 x 60 mm (1)	white	normal	EK-D2C-GAA	
	ice white	soft-touch *	EK-D2C-GAB	
	fire white	normal *	EK-D2C-GAC	
	fire white	soft-touch *	EK-D2C-GAD	
	intense black RAL 9005	normal	EK-D2C-GAE	
	intense black RAL 9005	soft-touch *	EK-D2C-GAF	
	silver	normal	EK-D2C-GAG	
	hematite	normal *	EK-D2C-GAI	
	graphite	normal *	EK-D2C-GAL	

\*) Version on request

# Deep double plate

WALL-MOUNT DEVICES

## ALUMINIUM

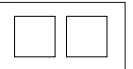
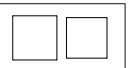
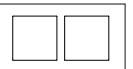
Series	Window	Colour	Finishing	Code
FF - 71	 45 x 45 mm (2)	aluminium	brushed	EK-D2E-GBQ
		nickel		EK-D2E-GBR
		titanium		EK-D2E-GBS
		carbon		EK-D2E-GBU
		brass		EK-D2E-GBB
		aluminium		EK-D2F-GBQ
	 45 x 45 mm (1) 60 x 60 mm (1)	nickel		EK-D2F-GBR
		titanium		EK-D2F-GBS
		carbon		EK-D2F-GBU
		brass		EK-D2F-GBB
		aluminium		EK-D2P-GBQ
		nickel		EK-D2P-GBR
	 55 x 55 mm (2)	titanium		EK-D2P-GBS
		carbon		EK-D2P-GBU
		brass		EK-D2P-GBB
		aluminium		EK-D2G-GBQ
		nickel		EK-D2G-GBR
		titanium		EK-D2G-GBS
 55 x 55 mm (1) 60 x 60 mm (1)	carbon	EK-D2G-GBU		
	brass	EK-D2G-GBB		
	aluminium	EK-D2S-GBQ		
	nickel	EK-D2S-GBR		
	titanium	EK-D2S-GBS		
	carbon	EK-D2S-GBU		
 60 x 60 mm (2)	brass	EK-D2S-GBB		
	aluminium	EK-D2C-GBQ		
	nickel	EK-D2C-GBR		
	titanium	EK-D2C-GBS		
	carbon	EK-D2C-GBU		
	brass	EK-D2C-GBB		

# Deep double plate

WALL-MOUNT DEVICES

**FENIX NTM®**

Series	Finestre	Colour	Code
20venti FF 71	45 x 45 mm (2)	malè white	EK-D2E-FBM
		beige luxor	EK-D2E-FBL
		beaver ottawa	EK-D2E-FCO
		cocoa orinoco	EK-D2E-FCC
		grey efeso	EK-D2E-FGE
	45 x 45 mm (1) 60 x 60 mm (1)	grey london	EK-D2E-FGL
		grey bromine	EK-D2E-FGB
		green commodore	EK-D2E-FVC
		black ingo	EK-D2E-FNI
		malè white	EK-D2F-FBM
	55 x 55 mm (2)	beige luxor	EK-D2F-FBL
		beaver ottawa	EK-D2F-FCO
		cocoa orinoco	EK-D2F-FCC
		grey efeso	EK-D2F-FGE
		grey london	EK-D2F-FGL
60 x 60 mm (2)	grey bromine	EK-D2F-FGB	
	green commodore	EK-D2F-FVC	
	black ingo	EK-D2F-FNI	
	malè white	EK-D2P-FBM	
	beige luxor	EK-D2P-FBL	
60 x 60 mm (1)	beaver ottawa	EK-D2P-FCO	
	cocoa orinoco	EK-D2P-FCC	
	grey efeso	EK-D2P-FGE	
	grey london	EK-D2P-FGL	
	grey bromine	EK-D2P-FGB	
120 x 60 mm (1)	green commodore	EK-D2P-FVC	
	black ingo	EK-D2P-FNI	
	malè white	EK-D2C-FBM	
	beige luxor	EK-D2C-FBL	
	beaver ottawa	EK-D2C-FCO	
60 x 60 mm (3)	cocoa orinoco	EK-D2C-FCC	
	grey efeso	EK-D2C-FGE	
	grey london	EK-D2C-FGL	
	grey bromine	EK-D2C-FGB	
	green commodore	EK-D2C-FVC	
60 x 60 mm (1)	black ingo	EK-D2C-FNI	

**FENIX NTM®**

Series	Finestre	Colour	Code
20venti FF 71	55 x 55 mm (1) 60 x 60 mm (1)	malè white	EK-D2G-FBM
		beige luxor	EK-D2G-FBL
		beaver ottawa	EK-D2G-FCO
		cocoa orinoco	EK-D2G-FCC
		grey efeso	EK-D2G-FGE
	60 x 60 mm (2)	grey london	EK-D2G-FGL
		grey bromine	EK-D2G-FGB
		green commodore	EK-D2G-FVC
		black ingo	EK-D2G-FNI
		malè white	EK-D2S-FBM
	60 x 60 mm (3)	beige luxor	EK-D2S-FBL
		beaver ottawa	EK-D2S-FCO
		cocoa orinoco	EK-D2S-FCC
		grey efeso	EK-D2S-FGE
		grey london	EK-D2S-FGL
60 x 60 mm (1)	grey bromine	EK-D2S-FGB	
	green commodore	EK-D2S-FVC	
	black ingo	EK-D2S-FNI	
	malè white	EK-D2C-FBM	
	beige luxor	EK-D2C-FBL	
60 x 60 mm (2)	beaver ottawa	EK-D2C-FCO	
	cocoa orinoco	EK-D2C-FCC	
	grey efeso	EK-D2C-FGE	
	grey london	EK-D2C-FGL	
	grey bromine	EK-D2C-FGB	
60 x 60 mm (3)	green commodore	EK-D2C-FVC	
	black ingo	EK-D2C-FNI	

**ALUMINIUM**

Series	Window	Colour	Finishing	Code
20venti FF 71	55 x 55 mm (3)	aluminium	brushed	EK-D3P-GBQ
		nickel		EK-D3P-GBR
		titanium		EK-D3P-GBS
		carbon		EK-D3P-GBU
		brass		EK-D3P-GBB
	60 x 60 mm (3)	aluminium		EK-D3S-GBQ
		nickel		EK-D3S-GBR
		titanium		EK-D3S-GBS
		carbon		EK-D3S-GBU
		brass		EK-D3S-GBB

# Deep triple plate

WALL-MOUNT DEVICES

**FENIX NTM®**

Series	Finestre	Colour	Code
20venti FF 71	55 x 55 mm (3)	malè white	EK-D3P-FBM
		beige luxor	EK-D3P-FBL
		beaver ottawa	EK-D3P-FCO
		cocoa orinoco	EK-D3P-FCC
		grey efeso	EK-D3P-FGE
	60 x 60 mm (3)	grey london	EK-D3P-FGL
		grey bromine	EK-D3P-FGB
		green commodore	EK-D3P-FVC
		black ingo	EK-D3P-FNI
		malè white	EK-D3S-FBM
	60 x 60 mm (2)	beige luxor	EK-D3S-FBL
		beaver ottawa	EK-D3S-FCO
		cocoa orinoco	EK-D3S-FCC
		grey efeso	EK-D3S-FGE
		grey london	EK-D3S-FGL
60 x 60 mm (1)	grey bromine	EK-D3S-FGB	
	green commodore	EK-D3S-FVC	
	black ingo	EK-D3S-FNI	

# How to order a Surface

WALL-MOUNT DEVICES

Surface plates for devices of 20venti, 71 series and flush-mounting inserts (20venti, FF and 71). The ordering code of a Surface plate consists of a fixed part (EK-S) and a variable part depending on shape (square or rectangular), window size (small or large), material, colour and finishing.

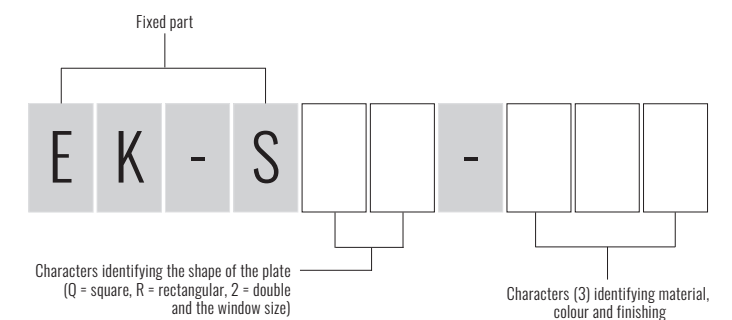











## Surface square plate

WALL-MOUNT DEVICES

### ALUMINIUM

Series	Window	Colour	Finishing	Code
20venti (4 rockers)		aluminium	brushed	EK-SQT-GBQ
		nickel		EK-SQT-GBR
		titanium		EK-SQT-GBS
		carbon		EK-SQT-GBU
		brass		EK-SQT-GBB
20venti FF 71		aluminium	EK-SQP-GBQ	
		nickel	EK-SQP-GBR	
		titanium	EK-SQP-GBS	
		carbon	EK-SQP-GBU	
		brass	EK-SQP-GBB	
20venti FF 71		aluminium	EK-SQG-GBQ	
		nickel	EK-SQG-GBR	
		titanium	EK-SQG-GBS	
		carbon	EK-SQG-GBU	
		brass	EK-SQG-GBB	
20venti FF 71		aluminium	EK-SQS-GBQ	
		nickel	EK-SQS-GBR	
		titanium	EK-SQS-GBS	
		carbon	EK-SQS-GBU	
		brass	EK-SQS-GBB	



### FENIX NTM®

Series	Window	Colour	Code
20venti (4 rockers)		malè white	EK-SQT-FBM
		beige luxor	EK-SQT-FBL
		beaver ottawa	EK-SQT-FCO
		cocoa orinoco	EK-SQT-FCC
		grey efeso	EK-SQT-FGE
		grey london	EK-SQT-FGL
		grey bromine	EK-SQT-FGB
		green commodore	EK-SQT-FVC
		black ingo	EK-SQT-FNI
		malè white	EK-SQP-FBM
		beige luxor	EK-SQP-FBL
		beaver ottawa	EK-SQP-FCO
		cocoa orinoco	EK-SQP-FCC
		grey efeso	EK-SQP-FGE
		grey london	EK-SQP-FGL
grey bromine	EK-SQP-FGB		
green commodore	EK-SQP-FVC		
black ingo	EK-SQP-FNI		
20venti FF 71		malè white	EK-SQG-FBM
		beige luxor	EK-SQG-FBL
		beaver ottawa	EK-SQG-FCO
		cocoa orinoco	EK-SQG-FCC
		grey efeso	EK-SQG-FGE
		grey london	EK-SQG-FGL
		grey bromine	EK-SQG-FGB
		green commodore	EK-SQG-FVC
		black ingo	EK-SQG-FNI
		malè white	EK-SQS-FBM
		beige luxor	EK-SQS-FBL
		beaver ottawa	EK-SQS-FCO
		cocoa orinoco	EK-SQS-FCC
		grey efeso	EK-SQS-FGE
		grey london	EK-SQS-FGL
grey bromine	EK-SQS-FGB		
green commodore	EK-SQS-FVC		
black ingo	EK-SQS-FNI		
20venti FF 71		malè white	EK-SQS-FBM
		beige luxor	EK-SQS-FBL
		beaver ottawa	EK-SQS-FCO
		cocoa orinoco	EK-SQS-FCC
		grey efeso	EK-SQS-FGE
		grey london	EK-SQS-FGL
		grey bromine	EK-SQS-FGB
		green commodore	EK-SQS-FVC
		black ingo	EK-SQS-FNI
		malè white	EK-SQS-FBM
		beige luxor	EK-SQS-FBL
		beaver ottawa	EK-SQS-FCO
		cocoa orinoco	EK-SQS-FCC
		grey efeso	EK-SQS-FGE
		grey london	EK-SQS-FGL
grey bromine	EK-SQS-FGB		
green commodore	EK-SQS-FVC		
black ingo	EK-SQS-FNI		
20venti FF 71		malè white	EK-SQS-FBM
		beige luxor	EK-SQS-FBL
		beaver ottawa	EK-SQS-FCO
		cocoa orinoco	EK-SQS-FCC
		grey efeso	EK-SQS-FGE
		grey london	EK-SQS-FGL
		grey bromine	EK-SQS-FGB
		green commodore	EK-SQS-FVC
		black ingo	EK-SQS-FNI



## Surface rectangular plate

WALL-MOUNT DEVICES

### ALUMINIUM

Series	Window	Colour	Finishing	Code
20venti FF 71		aluminium	brushed	EK-SRG-GBQ
		nickel		EK-SRG-GBR
		titanium		EK-SRG-GBS
		carbon		EK-SRG-GBU
		brass		EK-SRG-GBB
20venti FF 71		aluminium	EK-SRS-GBQ	
		nickel	EK-SRS-GBR	
		titanium	EK-SRS-GBS	
		carbon	EK-SRS-GBU	
		brass	EK-SRS-GBB	



### FENIX NTM®

Series	Window	Colour	Code
20venti (4 rockers)		malè white	EK-SRG-FBM
		beige luxor	EK-SRG-FBL
		beaver ottawa	EK-SRG-FCO
		cocoa orinoco	EK-SRG-FCC
		grey efeso	EK-SRG-FGE
		grey london	EK-SRG-FGL
		grey bromine	EK-SRG-FGB
		green commodore	EK-SRG-FVC
		black ingo	EK-SRG-FNI
		malè white	EK-SRS-FBM
		beige luxor	EK-SRS-FBL
		beaver ottawa	EK-SRS-FCO
		cocoa orinoco	EK-SRS-FCC
		grey efeso	EK-SRS-FGE
		grey london	EK-SRS-FGL
grey bromine	EK-SRS-FGB		
green commodore	EK-SRS-FVC		
black ingo	EK-SRS-FNI		
20venti FF 71		malè white	EK-SRS-FBM
		beige luxor	EK-SRS-FBL
		beaver ottawa	EK-SRS-FCO
		cocoa orinoco	EK-SRS-FCC
		grey efeso	EK-SRS-FGE
		grey london	EK-SRS-FGL
		grey bromine	EK-SRS-FGB
		green commodore	EK-SRS-FVC
		black ingo	EK-SRS-FNI

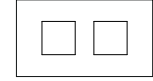
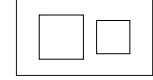
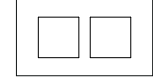
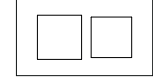
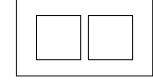
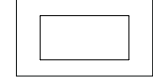
### ALUMINIUM

Series	Window	Colour	Finishing	Code
20venti FF 71		aluminium	brushed	EK-S2E-GBQ
		nickel		EK-S2E-GBR
		titanium		EK-S2E-GBS
		carbon		EK-S2E-GBU
		brass		EK-S2E-GBB
		aluminium	EK-S2F-GBQ	
		nickel	EK-S2F-GBR	
		titanium	EK-S2F-GBS	
		carbon	EK-S2F-GBU	
		brass	EK-S2F-GBB	
		aluminium	EK-S2P-GBQ	
		nickel	EK-S2P-GBR	
		titanium	EK-S2P-GBS	
		carbon	EK-S2P-GBU	
		brass	EK-S2P-GBB	
	aluminium	EK-S2G-GBQ		
	nickel	EK-S2G-GBR		
	titanium	EK-S2G-GBS		
	carbon	EK-S2G-GBU		
	brass	EK-S2G-GBB		
	aluminium	EK-S2S-GBQ		
	nickel	EK-S2S-GBR		
	titanium	EK-S2S-GBS		
	carbon	EK-S2S-GBU		
	brass	EK-S2S-GBB		
	aluminium	EK-S2C-GBQ		
	nickel	EK-S2C-GBR		
	titanium	EK-S2C-GBS		
	carbon	EK-S2C-GBU		
	brass	EK-S2C-GBB		

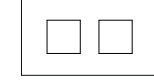
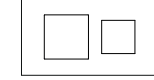
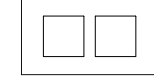
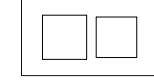
### FENIX NTM®

Series	Finestre	Colour	Code
20venti FF 71		malè white	EK-S2E-FBM
		beige luxor	EK-S2E-FBL
		beaver ottawa	EK-S2E-FCO
		cocoa orinoco	EK-S2E-FCC
		grey efeso	EK-S2E-FGE
		grey london	EK-S2E-FGL
		grey bromine	EK-S2E-FGB
		green commodore	EK-S2E-FVC
		black ingo	EK-S2E-FNI
		malè white	EK-S2F-FBM
		beige luxor	EK-S2F-FBL
		beaver ottawa	EK-S2F-FCO
		cocoa orinoco	EK-S2F-FCC
		grey efeso	EK-S2F-FGE
		grey london	EK-S2F-FGL
grey bromine	EK-S2F-FGB		
green commodore	EK-S2F-FVC		
black ingo	EK-S2F-FNI		
20venti FF 71		malè white	EK-S2F-FBM
		beige luxor	EK-S2F-FBL
		beaver ottawa	EK-S2F-FCO
		cocoa orinoco	EK-S2F-FCC
		grey efeso	EK-S2F-FGE
		grey london	EK-S2F-FGL
		grey bromine	EK-S2F-FGB
		green commodore	EK-S2F-FVC
		black ingo	EK-S2F-FNI
		malè white	EK-S2P-FBM
		beige luxor	EK-S2P-FBL
		beaver ottawa	EK-S2P-FCO
		cocoa orinoco	EK-S2P-FCC
		grey efeso	EK-S2P-FGE
		grey london	EK-S2P-FGL
grey bromine	EK-S2P-FGB		
green commodore	EK-S2P-FVC		
black ingo	EK-S2P-FNI		
20venti FF 71		malè white	EK-S2G-FBM
		beige luxor	EK-S2G-FBL
		beaver ottawa	EK-S2G-FCO
		cocoa orinoco	EK-S2G-FCC
		grey efeso	EK-S2G-FGE
		grey london	EK-S2G-FGL
		grey bromine	EK-S2G-FGB
		green commodore	EK-S2G-FVC
		black ingo	EK-S2G-FNI
		malè white	EK-S2S-FBM
		beige luxor	EK-S2S-FBL
		beaver ottawa	EK-S2S-FCO
		cocoa orinoco	EK-S2S-FCC
		grey efeso	EK-S2S-FGE
		grey london	EK-S2S-FGL
grey bromine	EK-S2S-FGB		
green commodore	EK-S2S-FVC		
black ingo	EK-S2S-FNI		
20venti FF 71		malè white	EK-S2G-FBM
		beige luxor	EK-S2G-FBL
		beaver ottawa	EK-S2G-FCO
		cocoa orinoco	EK-S2G-FCC
		grey efeso	EK-S2G-FGE
		grey london	EK-S2G-FGL
		grey bromine	EK-S2G-FGB
		green commodore	EK-S2G-FVC
		black ingo	EK-S2G-FNI
		malè white	EK-S2C-FBM
		beige luxor	EK-S2C-FBL
		beaver ottawa	EK-S2C-FCO
		cocoa orinoco	EK-S2C-FCC
		grey efeso	EK-S2C-FGE
		grey london	EK-S2C-FGL
grey bromine	EK-S2C-FGB		
green commodore	EK-S2C-FVC		
black ingo	EK-S2C-FNI		
20venti FF 71		malè white	EK-S2C-FBM
		beige luxor	EK-S2C-FBL
		beaver ottawa	EK-S2C-FCO
		cocoa orinoco	EK-S2C-FCC
		grey efeso	EK-S2C-FGE
		grey london	EK-S2C-FGL
		grey bromine	EK-S2C-FGB
		green commodore	EK-S2C-FVC
		black ingo	EK-S2C-FNI



# DIN-RAIL MOUNT MODULES

Power supply units	182
System modules	185
Universal interfaces	189
Inputs and actuators	197
I / O modules	204
Dimmers	207
Thermoregulation and PLC	214
Gateways	224
Metering	234





ekinex

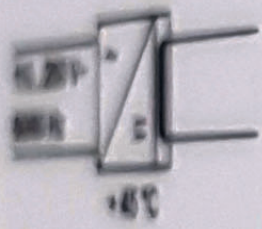

30 Vdc  
 $I \leq 640 \text{ mA}$

+45°C

ON

$I > I_{max}$

KNX EK-LM2-TP  
Power supply 640 mA

8 5 4 3 2 1

ekinex

EK-LM2-TP

Modulo logico programmabile  
Programmable logical module

1 148X 40 X 7 (EKO0611)



## Power supply units

DIN-RAIL MOUNT MODULES

EK-AB1-TP  
640 mA bus power supply

EK-AG1-TP  
640 mA bus power supply with 30 Vdc auxiliary output



Power supply of a KNX bus line with max. 64 bus devices connected	•	•
Reset of the connected bus line through pushbutton	•	•
LED for output voltage on KNX bus	•	•
LED for overload / short circuit on KNX bus	•	•
Integrated decoupling choke	•	•
Power supply 110-230 Vac 50/60 Hz	•	•
Output for auxiliary power supply 30 Vdc	-	•
Mounting on standard 35 mm rail (EN 60715)	•	•

## System modules

DIN-RAIL MOUNT MODULES

EK-TM1-TP  
Time / astronomical digital switch

EK-BD1-TP  
USB interface

EK-BA1-TP  
Line / area coupler

EK-BB1-TP  
IP interface

EK-BC1-TP  
IP router



Suppress device configuration on the sub line	-	-	•	•	•
Enable or disable filtering of group messages and suppress device oriented messages	-	-	•	•	•
Trace the traffic on the sub line and reduced number of retransmissions	-	-	•	•	•
Function pushbutton	•	-	•	•	•
Status LED for KNX bus line	-	•	•	•	•
Status LED for Ethernet	-	-	-	•	•
Mounting on standard 35 mm rail (EN 60715)	•	•	•	•	•
Plug in program	•	-	-	-	-
Programming pushbutton	-	•	-	•	•
Connection of a PC or laptop to the KNX bus system	-	-	-	•	•
Time programming (daily, weekly, monthly or yearly) or astronomical	•	-	-	-	-
Control of 9 channels on bus	•	-	-	-	-
Channel 1 can be replicated on the relay on board	•	-	-	-	-
LC-display	•	-	-	-	-
Backup battery	•	-	-	-	-
Connection of an optional GPS module	•	-	-	-	-



### Description

The Ekinex® 640 mA KNX bus power supply supplies and monitors the 30 Vdc voltage required by the KNX bus for operation. An integrated choke provides for decoupling power supply and bus line. On a bus line powered by a 640 mA power supply unit may be connected a maximum of 64 bus devices. Output is protected from overload and short-circuit. The EK-AG1-TP version is provided with an additional 30 Vdc output can be used as auxiliary power supply for other devices requiring SELV voltage (Safety Extra Low Voltage). The total current provided by the two outputs (KNX bus line and auxiliary power supply) cannot exceed 640 mA. The device supports short network voltage interruptions (max. 200 ms).

### Main features

- Plastic casing
- Connection to bus line with KNX terminal block
- Connection of auxiliary output with dedicated terminal block (only EK-AG1-TP)
- Connection of 230 Vac power supply with screw terminals
- Classification climatic 3K5 and mechanical 3M2 (according to EN 50491-2)
- Pollution degree 2 (according to IEC 60664-1)
- Safety class II
- Installation on 35 mm rail (according to EN 60715)
- 4 modular units (1 MU = 18 mm)
- IP20 protection grade (installed device)
- Weight 150 g (EK-AB1-TP), 165 g (EK-AG1-TP)

### Order information

Code	Version	Package
EK-AB1-TP		1 pcs.
EK-AG1-TP	with 30 Vdc auxiliary output	1 pcs.

## 640 mA bus power supply

POWER SUPPLY UNITS

### Technical data

- Input voltage: 230 Vac, 50/60 Hz
- Power absorption 22 W
- Loss < 3 W
- Output voltage (KNX bus): 30 Vdc
- Output voltage (auxiliary output): 30 Vdc (only EK-AG1-TP)
- Nominal current (output total): 640 mA
- Buffer time: 200 ms

### Products included

Delivery includes one terminal blocks for connection to the bus; the EK-AG1-TP version is delivered with a second terminal block for connection to the auxiliary output.

### Dimensions [mm]

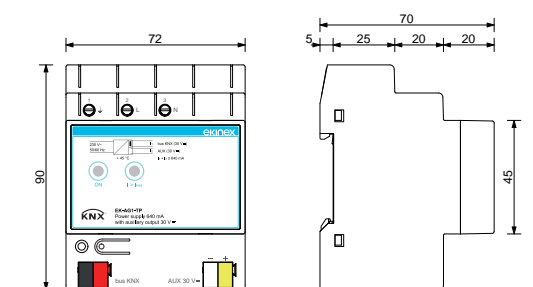

Terminal block for auxiliary output (white/yellow) only on EK-AG1-TP version



### Configuration and commissioning

Not necessary



### Documentation

For more information, see the **STEKAB1TP\_EN.pdf** or **STEKAG1TP\_EN.pdf** technical sheets available for download from [www.ekinex.com](http://www.ekinex.com)



EK-AB1-TP EK-AG1-TP





## Time / astronomical digital switch

SYSTEM DEVICES

### Description

The EK-TM1-TP electronic digital time switch is a KNX device for the management over time of the electrical devices. It allows time programming (periodicity: daily, weekly or annual) or astronomical programming. The device can pilot 9 different channels on KNX bus. The relay on the device replicates the channel 1 programming. Each channel can be associated with a different programming (time or astronomical). It is possible to connect via bus the EK-GPS-1 module (to be ordered separately), that captures the time and the position through the satellite system, ensuring a greater accuracy over time. The backup battery keeps the settings even in case of power failure and can be replaced through the cover (sealable).

### Main features

- Plastic casing
- LCD with backlight (active only with AC power supply)
- Password lockable keyboard
- 450 storable programs (900 events) divisible on 9 channels
- Daily/weekly/monthly/yearly + astronomical programming
- On/off, pulse, holiday, random, night (astronomical) programmes
- Programming resolution 1 minute
- Actions type 1B
- Automatic update of daylight saving time (configurable)
- Connection to bus line with KNX terminal block
- Screw terminal blocks for connecting 230 Vac, output and GPS module
- Lithium backup battery: 3V, CR14250 type (5-years life, replaceable)
- Reinforced insulation between accessible parts (front) and all the other terminals
- Protection degree IP20 (device installed)
- Mounting on 35 mm standard DIN-rail (according to EN 60715)
- 3 modular units (1 UM = 18 mm)

### Technical data

- Power supply: 115 ÷ 230 Vac (-15% ÷ +10%) 50/60 Hz
- Power consumption: 7 VA (2.6 W)

### Output

- 1 monostable switching relay 16(10) A at 250 Vac

### Products included

Delivery includes a terminal block for connection to the bus. The optional module EK-GPS-1 has to be ordered separately.

### Dimensions [mm]

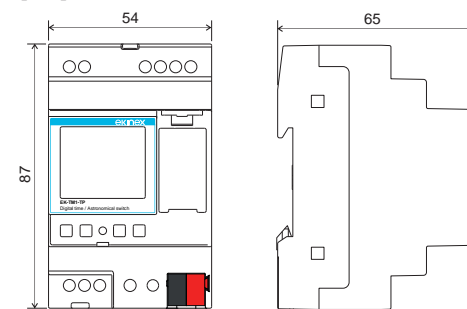

### Order information

Code	Package
EK-TM1-TP	1 pcs.
EK-GPS-1	1 pcs.



### Configuration and commissioning

By means of ETSS software or later versions  
Application program: **APEKTM1TP##.knxprod**  
(## = version, downloadable from [www.ekinex.com](http://www.ekinex.com))



### Documentation

For more information, see the **STEKTM1TP\_EN.pdf** technical sheet available for download from [www.ekinex.com](http://www.ekinex.com)



EK-TM1-TP EK-GPS-1



## USB interface

SYSTEM MODULES

### Description

The Ekinex® USB interface EK-BD1-TP allows a bidirectional data connection between a PC and a KNX bus system. The device handles the addressing, parameter setting, display, protocol management and diagnosis of KNX bus devices. The device integrates a KNX bus communication module and is realized for mounting on a standard 35 mm DIN-rail.

### Main features

- Plastic casing
- LEDs indicators for data transmission on USB and KNX bus status
- Connection to bus line with KNX terminal block
- Connection to PC with USB type B connector
- Installation on 35 mm rail (according to EN 60715)
- 2 modular units (1 MU = 18 mm)
- IP20 protection degree (installed device)
- Weight 100 g

### Technical data

- Power supply (bus side): 30 Vdc SELV, current consumption: max. 10 mA
- Power supply (PC side): from USB, current consumption: max. 20 mA

### Products included

Delivery includes a terminal block for connection to the bus.

### Dimensions [mm]

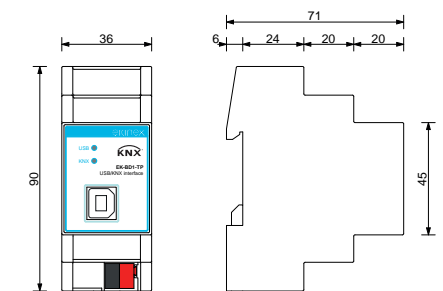

### Order information

Code	Package
EK-BD1-TP	1 pcs.



### Configuration and commissioning

Not necessary; the application program **APEKBD1TP##.vd4** (download from [www.ekinex.com](http://www.ekinex.com)) is available for an ETS project.



### Documentation

For more information, see the **STEKBD1TP\_EN.pdf** technical sheet available for download from [www.ekinex.com](http://www.ekinex.com)





## Line / area coupler

SYSTEM MODULES

### Description

The Ekinex® line / area coupler EK-BA1-TP can be used as a line coupler to connect a secondary line to a main line, as an area coupler to connect a main line to a backbone line or as a repeater. The device assures galvanic insulation between the two connected lines and filters the traffic based on installation position or on filter tables in case of group-oriented communications. The frontal LEDs indicate the status of each bus line and facilitate the tracing of communication problems due to bus load or to re-transmission on both lines. The device integrates a KNX bus communication module and is realized for mounting on a standard 35 mm DIN-rail.

### Main features

- Plastic casing
- Frontal programming pushbutton and LED
- LEDs indicators for status of KNX bus lines
- Pushbutton for activating special functions
- Connection to bus lines with KNX terminal blocks
- Installation on 35 mm rail (according to EN 60715)
- 2 modular units (1 MU = 18 mm)
- IP20 protection degree (installed device)
- Weight 100 g

### Technical data

- 30 Vdc power supply by KNX bus
- Current consumption (from main bus line) ca.10 mA

### Functions

- Suppress device configuration on the sub line
- Enable or disable filtering of group messages
- Suppress device oriented messages
- Trace the traffic on the sub line
- Reduced number of retransmissions

### Products included

Delivery includes two terminal blocks for connection to the bus lines.

### Dimensions [mm]

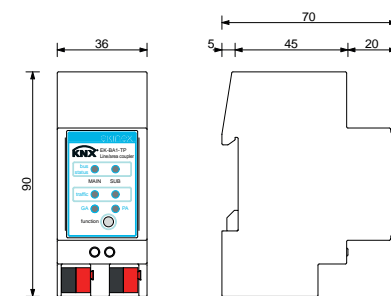

### Order information

Code	Package
EK-BA1-TP	1 pcs.



### Configuration and commissioning

By means of ETS5 software or later versions  
Application program **APEKBA1TP#.#.vd4** (download from [www.ekinex.com](http://www.ekinex.com))



### Documentation

For more information, see the **STEKBA1TP\_EN.pdf** technical sheet available for download from [www.ekinex.com](http://www.ekinex.com)



## IP interface

SYSTEM MODULES

### Description

The Ekinex® EK-BB1-TP IP interface realizes the bidirectional data connection between a PC or a laptop and a KNX bus system through a LAN network. The IP interface supports the tunneling protocol and allows the addressing, parameter setting, display, protocol management and diagnosis of KNX bus devices with ETS. The device integrates a KNX bus communication module and is realized for mounting on a standard 35 mm DIN-rail. The device is powered by a 8...24 Vac or 12...35 Vdc voltage.

### Main features

- Plastic casing
- Frontal programming pushbutton and LED
- LEDs indicators for status and data traffic of KNX bus line and Ethernet network
- Pushbutton for activating special functions
- Connection to bus line with KNX terminal block
- Connection to an Ethernet network with a RJ45 connector
- Installation on 35 mm rail (according to EN 60715)
- 2 modular units (1 MU = 18 mm)
- IP20 protection degree (installed device)
- Weight 70 g

### Technical data

- 30 Vdc power supply by KNX bus
- Current consumption max. 38 mA

### Products included

Delivery includes a terminal block for connection to the bus.

### Dimensions [mm]

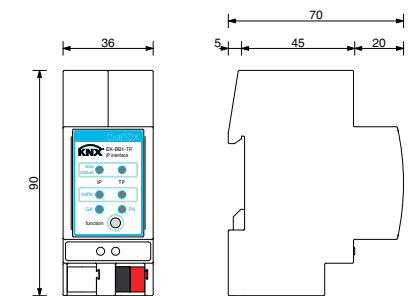

### Order information

Code	Package
EK-BB1-TP	1 pcs.



### Configuration and commissioning

By means of ETS5 software or later versions  
Application programs **APEKBB1TP#.#.knxprod** (download from [www.ekinex.com](http://www.ekinex.com))



### Documentation

For more information, see the **STEKBB1TP\_EN.pdf** technical sheets available for download from [www.ekinex.com](http://www.ekinex.com)







## IP router

SYSTEM MODULES

### Description

The Ekinex® EK-BC1-TP IP router realizes the bidirectional data connection between a PC or a laptop and a KNX bus system through a LAN network. The IP router supports the tunneling protocol and allows the addressing, parameter setting, display, protocol management and diagnosis of KNX bus devices with ETS. The IP router integrates also the line coupling function; through the device telegrams can be exchanged between KNX TP lines on a TCP / IP backbone line. The device integrates a KNX bus communication module and is realized for mounting on a standard 35 mm DIN-rail. The device is powered by the KNX bus and does not require auxiliary power supply.

### Main features

- Plastic casing
- Frontal programming pushbutton and LED
- LEDs indicators for status and data traffic of KNX bus line and Ethernet network
- Pushbutton for activating special functions
- Connection to bus line with KNX terminal block
- Connection to an Ethernet network with a RJ45 connector
- Installation on 35 mm rail (according to EN 60715)
- 2 modular units (1 MU = 18 mm)
- IP20 protection degree (installed device)
- Weight 70 g

### Technical data

- 30 Vdc power supply by KNX bus
- Current consumption max. 38 mA

### Products included

Delivery includes a terminal block for connection to the bus.

### Dimensions [mm]

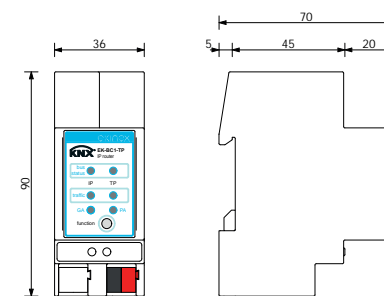

## Universal interfaces

RAIL AND FLUSH-MOUNTING DEVICES

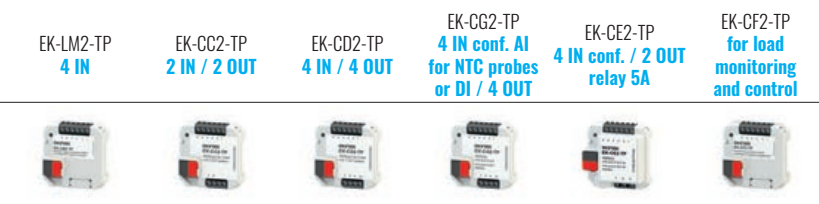

	EK-LM2-TP 4 IN	EK-CC2-TP 2 IN / 2 OUT	EK-CD2-TP 4 IN / 4 OUT	EK-CG2-TP 4 IN conf. AI for NTC probes or DI / 4 OUT	EK-CE2-TP 4 IN conf. / 2 OUT relay 5A	EK-CF2-TP for load monitoring and control
Input channels [DI]	4	2	4	-	3	-
Channels configurable as input [DI] or output [DO] for low-consumption LEDs	-	-	-	-	-	-
Input channels configurable as [AI] for NTC probes or [DI]	-	-	-	4	1	-
Input channels for current transformers EK-TA-...	-	-	-	-	-	3
Output channels for low-consumption LEDs	-	2	4	4	-	-
Output channels relay (5A)	-	-	-	-	2	-
ON/OFF command of single or grouped loads	-	•	•	•	•	-
Dimming command of lighting devices	-	•	•	•	•	-
Actuator command of shutters, blinds, venetians, etc.	-	•	•	•	•	-
Detection of the status of the indication contacts	•	•	•	•	•	-
Sending and storing of scenes	-	•	•	•	•	-
Logic functions (AND, OR or XOR), 4 channels	•	•	•	•	•	•
Room thermostat function	-	-	-	•	•	-
Pulse and actuator counting	-	•	•	•	•	-
Mounting on 35 mm standard DIN rail (EN 60715) through support EK-SMG-35	•	•	•	•	•	•

### Order information

Code	Package
EK-BC1-TP	1 pcs.



### Configuration and commissioning

By means of ETS5 software or later versions  
Application programs **APEKBC1TP##.knxprod** (download from [www.ekinex.com](http://www.ekinex.com))



### Documentation

For more information, see the **STEKBC1TP\_EN.pdf** technical sheets available for download from [www.ekinex.com](http://www.ekinex.com)





## Configurable logical module

UNIVERSAL INTERFACES

### Description

The configurable logical module Ekinex® EK-LM2-TP is a KNX S-mode device that can be used to perform logic and data processing functions on data exchanged on the KNX bus. The device is suitable for mounting in wall box or on 35 mm rail (EN 60715) with the support EK-SMG-35 included in the delivery. To be used in KNX installations for home and building automation. The device is powered by the KNX bus line with a SELV voltage 30 Vdc and does not require auxiliary power.

### Main features

- Housing in plastic material
- Wall installation in flush mounting box or, with a mounting support, on 35 mm rail (according to EN 60715)
- Protection degree IP20 (installed device)
- Classification climatic 3K5 and mechanical 3M2 (according to EN 50491-2)
- Pollution degree 2 (according to IEC 60664-1)
- Weight 20 g

### Functions

The device implements independent blocks of the below listed types:

- **Logic:** Combines a number of boolean inputs according to logic operations.
- **Arithmetic:** Performs mathematical computations on one or more input values.
- **Range:** Performs a scaling of the input value to a different range of values, or a boundary limit.
- **Mapping:** Translates a set of input values (up to 8 points) to a different set of output values.
- **Conversion:** Converts a KNX communication object to another one with a different KNX data type (DPT).
- **Timer:** Implements a one-shot (monostable) or freerunning (astable) timer, with configurable on- and offdelay times.
- **Compare:** Returns the result of a comparison (equal, larger, smaller etc.) between two input values
- **Multiplexer:** Copies the value of one input object to either 1 of N output objects, or to all objects selected in the output set.

### Order information

Code	Version	Package
EK-LM2-TP	4 IN	1 pcs.

Each function can be configured in different ways by means of parameters in the ETS application. There are several independent instances available for each type of block, therefore the device can be used to fulfill many requirements or to solve a large number of contingencies in the same installation. An additional terminal block allows the connection of up to 4 dry contacts for simple external inputs.

### Power supply

- 30 Vdc power supply by KNX bus
- Current consumption from bus < 10 mA

### Products included

Delivery includes a terminal block for connection to the bus.

### Accessories

Support for mounting on a standard 35 mm DIN-rail (code EK-SMG-35) and spring for snapping on the back of Ekinex® wall-mount devices (code EK-MAR-...) to be ordered separately.

### Dimensions [mm]

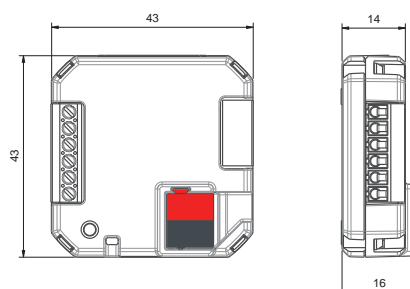

### Configuration and commissioning

By means of ETS5 software or later versions  
Application program **APEKLM2TP##.knxprod** (download from [www.ekinex.com](http://www.ekinex.com))



### Documentation

For more information, see the **STEKLM2TP\_EN.pdf** technical sheet available for download from [www.ekinex.com](http://www.ekinex.com)



## Universal interface

UNIVERSAL INTERFACES

### Description

The Ekinex® universal interface is a KNX device which can be used as input and/or output module. The device is equipped with:  
- inputs to connect the KNX bus to switches, pushbuttons or classic sensors (normally not communicating on the KNX bus) or any binary signals from other devices, in order to control KNX bus functions;  
- control outputs for low consumption LEDs.  
The voltage for polling the inputs is supplied within the device. The device integrates a KNX bus communication module and is realized for flush-mounting or for mounting on a standard 35 mm DIN-rail. The device is powered by the KNX bus and does not require auxiliary power supply.

### Main features

- Plastic casing
- Programming pushbutton and LED on the case
- Connection to bus line with KNX terminal block
- Screw terminal blocks for connecting inputs and outputs
- IP20 protection degree (installed device)
- Weight 20 g

### Power supply

- 30 Vdc power supply by KNX bus
- Current consumption from bus < 10 mA

### Products included

Delivery includes a terminal block for connection to the bus.

### Accessories

Support for mounting on a standard 35 mm DIN-rail (code EK-SMG-35) and spring for snapping on the back of Ekinex® wall-mount devices (code EK-MAR-...) to be ordered separately.

### Dimensions [mm]

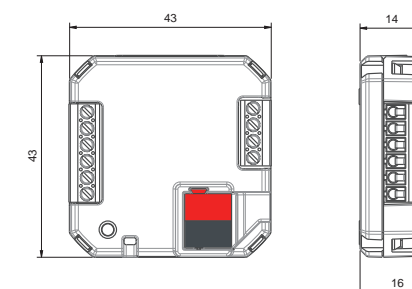

### Order information

Code	Version	Package
EK-CC2-TP	2 IN / 2 OUT	1 pcs.
EK-CD2-TP	4 IN / 4 OUT	1 pcs.



### Configuration and commissioning

By means of ETS5 software or later versions  
Application program **APEKCC2TP##.knxprod** (EK-CC2-TP) or  
**APEKCD2TP##.knxprod** (EK-CD2-TP) (download from [www.ekinex.com](http://www.ekinex.com))



### Documentation

For more information, see the **STEKCC2TP\_EN.pdf** technical sheet available for download from [www.ekinex.com](http://www.ekinex.com)



EK-CC2-TP



EK-CD2-TP





## Universal interface 4 configurable IN, 4 OUT

UNIVERSAL INTERFACES

### Description

The Ekinex® EK-CG2-TP pushbutton interface is a KNX device which can be used as input and/or output module. The device is equipped with 4 configurable inputs and 4 control outputs for low consumption LEDs.

Inputs can be independently configured to connect the KNX bus to:

- switches, pushbuttons, classic sensors (normally not communicating on the KNX bus ) or any binary signals from other devices, in order to control KNX bus functions;
- passive temperature sensors (NTC 10 kΩ at 25°C). The environment air mass temperature value, measured by those sensors, can be sent onto the bus or be used to control a room or zone temperature through the integrated thermostat function.

The voltage for polling the inputs is supplied within the device. The device integrates a KNX bus communication module and is realized for flush-mounting or for mounting on a standard 35 mm DIN-rail. The device is powered by the KNX bus and does not require auxiliary power supply.

### Main features

- Plastic casing
- Programming pushbutton and LED on the case
- Connection to bus line with KNX terminal block
- Screw terminal blocks for connecting inputs and outputs
- IP20 protection degree (installed device)
- Weight 20 g

### Power supply

- 30 Vdc power supply by KNX bus
- Current consumption from bus < 10 mA

### Products included

Delivery includes a terminal block for connection to the bus. The NTC temperature sensors (page 231) for those channels configured as [AI] must be ordered separately.

### Accessories

Support for mounting on a standard 35 mm DIN-rail (code EK-SMG-35) and spring for snapping on the back of Ekinex® wall-mount devices (code EK-MAR-...) to be ordered separately.

### Dimensions [mm]

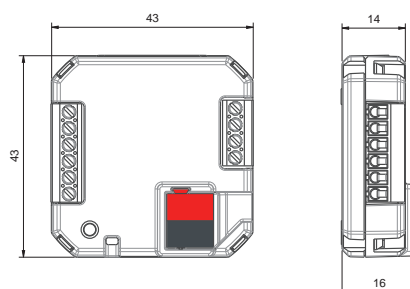

### Configuration and commissioning

By means of ETS5 software or later versions  
Application program **APEKCG2TP##.knxprod** (download from [www.ekinex.com](http://www.ekinex.com))



### Documentation

For more information, see the **STEKCG2TP\_EN.pdf** technical sheet available for download from [www.ekinex.com](http://www.ekinex.com)



## Universal interface 4 IN, 2 OUT (relay 5A)

UNIVERSAL INTERFACES

### Description

The Ekinex® universal interface is a KNX device which can be used as input and/or output module. The device is equipped with:

- 4 inputs to connect the KNX bus to switches, pushbuttons or classic sensors (normally not communicating on the KNX bus) or any binary signals from other devices, in order to control KNX bus functions. In addition, one input is configurable as analog to connect a NTC temperature sensor (10 kΩ at 25 °C);
- 2 5A relay outputs to be used as electrical load control (independent) or paired for shutter and blind actuator control.

The voltage for polling the inputs is supplied within the device. The device integrates a KNX bus communication module and is realized for flush-mounting or for mounting on a standard 35 mm DIN-rail. The device is powered by the KNX bus and does not require auxiliary power supply.

### Main features

- Plastic casing
- Programming pushbutton and LED on the case
- Connection to bus line with KNX terminal block
- Screw terminal blocks for connecting inputs and outputs
- IP20 protection degree (installed device)
- Weight 35 g

### Power supply

- 30 Vdc power supply by KNX bus
- Current consumption from bus < 10 mA

### Products included

Delivery includes a terminal block for connection to the bus. The NTC temperature sensors (page 231) for those channels configured as [AI] must be ordered separately.

### Accessories

Support for mounting on a standard 35 mm DIN-rail (code EK-SMG-35) and spring for snapping on the back of Ekinex® wall-mount devices (code EK-MAR-...) to be ordered separately.

### Dimensions [mm]

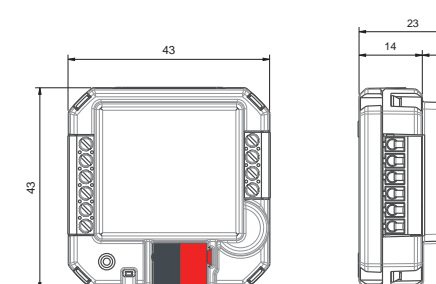

### Order information

Code	Package
EK-CE2-TP	1 pcs.



### Configuration and commissioning

By means of ETS5 software or later versions  
Application program **APEKCE2TP##.knxprod** (download from [www.ekinex.com](http://www.ekinex.com))



### Documentation

For more information, see the **STEKCE2TP\_EN.pdf** technical sheet available for download from [www.ekinex.com](http://www.ekinex.com)





## Load monitoring and control interface

UNIVERSAL INTERFACES

### Description

The Ekinex® EK-CF2-TP interface for load monitoring and control is a KNX device which can be used to:

- measure the instantaneous current absorbed by (up to) three single-phase or one three-phase electrical circuits;
- control electrical loads with priority disconnection and reconnection.

The current measurement is performed by means of max three Ekinex® EK-TA-... current transformers. The device is powered by the KNX bus and does not require auxiliary power supply. Flush-mounting or mounting on a standard 35 mm DIN-rail by means of a support included in the delivery.

### Main features

- Plastic casing
- Programming pushbutton and LED on the case
- Connection to bus line with KNX terminal block
- Connection to current transformers by means of a 6-wire screw terminal block
- IP20 protection degree (installed device)
- Weight 20 g

### Functional characteristics

- Connection to current transformers EK-TA-... by means of 3 physical inputs
- Possibility to measure (up to) three single-phase or one three-phase lines;
- Possibility to receive power values from bus
- 8 general purpose power thresholds
- 4 4-channel logic functions (AND, OR or XOR)

### Load monitoring

- Direct measurement of instantaneous current by means of transformers EK-TA-...
- Calculation of instantaneous power
- Total electricity metering
- Sending on the bus of measured current, power and energy values

### Order information

Code	Package
EK-CF2-TP	1 pcs.

### Load control

- Possibility to independently handle up to 8 loads for each channel
- Configurable power threshold for load control and related hysteresis
- Sending on the bus of an indication when the threshold is reached
- Possibility to exclude loads from the bus
- Disconnection and reconnection delay independently configurable for each channel

### Power supply

- 30 Vdc power supply by KNX bus
- Current consumption from bus < 10 mA

### Products included

Delivery includes a terminal block for connection to the bus and a support for mounting on a standard 35 mm DIN-rail. Current transformers EK-TA-... (page 151) must be ordered separately.

### Dimensions [mm]

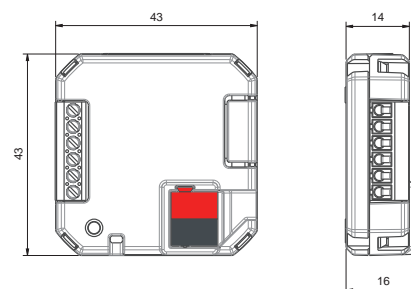

### Configuration and commissioning

By means of ETS5 software or later versions  
Application program **APEKCF2TP#.knxprod**  
(download from [www.ekinex.com](http://www.ekinex.com))



### Documentation

For more information, see the **STEKCF2TP\_EN.pdf** technical sheet available for download from [www.ekinex.com](http://www.ekinex.com)



## Current transformer (TA) for EK-CF2-TP interface

ACCESSORIES FOR UNIVERSAL INTERFACES

### Description

Current transformer (TA) to be used in combination with an Ekinex® EK-CF2-TP load monitoring and control interface.

### Main features

- Plastic casing
- Ferrite core
- 1,5 m connecting cable with free ends
- Weight: 55 g

### Technical data

- Nominal voltage: 0...1 Vac
- Precision: ±1 %
- Linearity: ≤ 0,2 %
- Operation frequency: 50...1KHz
- Dielectric resistance (50 Hz, 1 min): 3 KV
- Fire resistance: UL 94-V0

### Dimensions [mm]

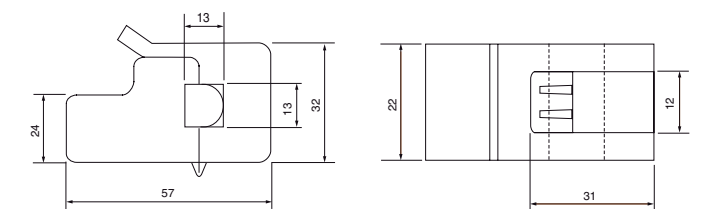

### Order information

Code	Nominal current [A]	Package
EK-TA-05A	0...5	1 pcs.
EK-TA-20A	0...20	1 pcs.
EK-TA-30A	0...30	1 pcs.
EK-TA-40A	0...40	1 pcs.
EK-TA-50A	0...50	1 pcs.
EK-TA-60A	0...60	1 pcs.



### Configuration and commissioning

The device does not require any configuration. The used version must be set in the application program of the EK-CF2-TP interface.



### Documentation

For more information, see the **STEKTA\_EN.pdf** technical sheet available for download from [www.ekinex.com](http://www.ekinex.com)







## Support for DIN-rail mounting

ACCESSORIES FOR UNIVERSAL INTERFACES

### Description

Support for mounting universal interfaces (except EK-CB2-TP) on a standard 35 mm DIN-rail.

#### Order information

Code	Package
EK-SMG-35-1	1 pcs.
EK-SMG-35-5	5 pcs.



## Inputs

DIN-RAIL MOUNT MODULES

EK-CA1-TP  
8-fold  
binary input



ON / OFF switching of individual loads or groups of loads	•
Dimming control for lighting devices	•
Operating control for shutters and roller blinds	•
Detecting the status of signaling contacts	•
Recalling and saving of scenes	•
Pushbutton for toggling between manual and automatic operation	•
Pushbuttons for forced operation of the inputs	•
Counting of impulses and switching cycles	•
Mounting on standard 35 mm rail (EN 60715)	•



## Spring for snapping on wall-mount devices

ACCESSORIES FOR UNIVERSAL INTERFACES

### Description

Spring for snapping universal interfaces (except EK-CB2-TP) on the back of Ekinex® wall-mount devices.

#### Order information

Code	Package
EK-MAR-1	1 pcs.
EK-MAR-5	5 pcs.



# 8-fold binary input

INPUTS



### Description

The Ekinex® EK-CA1-TP binary input has 8 independent input channels for connecting to the KNX bus commands and sensors of traditional type, having potential-free contacts. Thanks to the binary input, it is possible to command and control bus functions with standard switches, pushbuttons or sensors (not natively communicating with the KNX bus) or binary signals made available by other devices. The query voltage of input channels is produced within the device. The device integrates a KNX bus communication module and is realized for mounting on a standard 35 mm DIN-rail. The device is supplied by the KNX bus and does not require auxiliary power supply.

### Main features

- Plastic casing
- Frontal programming pushbutton and LED
- Membrane keyboard with LED's for status indication
- Pushbutton for switching operating mode (normal / programming)
- Connection to bus line with KNX terminal block
- Connection of inputs with screw terminals
- Installation on 35 mm rail (according to EN 60715)
- 4 modular units (1 MU = 18 mm)
- IP20 protection degree (installed device)
- Weight 145 g

### Technical data

#### Power supply

- Voltage 30 Vdc by KNX bus
- Current consumption from bus < 13 mA
- Power on bus 320 mW

#### Inputs

- Number: 8
- Query voltage: < 11 V
- Query current: < 5 mA

### Products included

Delivery includes a terminal block for connection to the bus.

### Dimensions [mm]

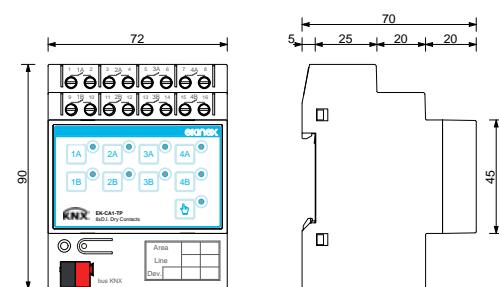

# Actuators

DIN-RAIL MOUNT MODULES

EK-FA1-TP 4-fold binary output	EK-FB1-TP 8-fold binary output	EK-FE1-TP 8-fold binary output / 4-fold blind actuator	EK-FF1-TP 16-fold binary output / 8-fold blind actuator
--------------------------------------	--------------------------------------	---	--



ON / OFF switching of individual loads or groups of loads	•	•	•	•
Configurable as normally open or normally closed switch	•	•	•	•
Logical gates and forced mode for each channel	•	•	•	•
Manual control by membrane pushbuttons	-	-	•	•
Manual control by levers (also without bus voltage)	•	•	-	-
Status feedback of output channels through the position of the levers	•	•	-	-
Status feedback of output channels through LEDs	-	-	•	•
Switching pushbutton manual / automatic mode	-	-	•	•
Block function for each channel	-	-	•	•
Auxiliary power supply	-	-	•	•
Time scheduling: switching delay for on and off, staircase lighting function	•	•	•	•
Management of scenarios	•	•	•	•
Operating hours counter configurable via bus	•	•	•	•
Shutters / blinds operation mode	-	-	•	•
Automatic control for protection against direct sunlight	-	-	•	•
Automatic control for protection against weather conditions (rain, wind, frost)	-	-	•	•
Mounting on standard 35 mm rail (EN 60715)	•	•	•	•

### Order information

Code	Package
EK-CA1-TP	1 pcs.



### Configuration and commissioning

By means of ETS5 software or later versions  
Application program **APEKCA1TP#.knxprod**  
(download from [www.ekinex.com](http://www.ekinex.com))



### Documentation

For more information, see the **STEKCA1TP\_EN.pdf**  
technical sheet available for download from [www.ekinex.com](http://www.ekinex.com)





## 4-fold binary output

ACTUATORS



### Description

The Ekinex® EK-FA1-TP binary output allows to command 4 groups of loads independently; to this purpose, the device has outputs fitted with potential-free relays. The device's latching relays guarantee the upkeep of command status even in the case of bus power failures. The front levers indicate the status of each output channel and, in case of emergency, allow manual command (by means of a tool) of the loads. The device integrates a KNX bus communication module and is realized for mounting on a standard 35 mm DIN-rail. The device is supplied by the KNX bus and does not require auxiliary power supply.

### Main features

- Plastic casing
- Frontal programming pushbutton and LED
- Connection to bus line with KNX terminal block
- Connection of outputs with screw terminals
- Overvoltage class III (according to EN 60664-1)
- Classification climatic 3K5 and mechanical 3M2 (according to EN 50491-2)
- Pollution degree 2 (according to IEC 60664-1)
- Installation on 35 mm rail (according to EN 60715)
- 4 modular units (1 MU = 18 mm)
- IP20 protection degree (installed device)
- Weight 205 g

### Technical data

#### Power supply

- 30 Vdc voltage by KNX bus
- Current consumption from bus < 12 mA
- Power from bus 360 mW

#### Outputs

- 4 latch relays
- Nominal voltage (U<sub>n</sub>): 100-230Vac, 50/60Hz
- Nominal current (I<sub>n</sub>): max 10 A (both @100Vac and @230Vac)
- Switched power: 1000W @100Vac - 2200 W @230Vac

### Products included

Delivery includes a terminal block for connection to the bus.

### Dimensions [mm]

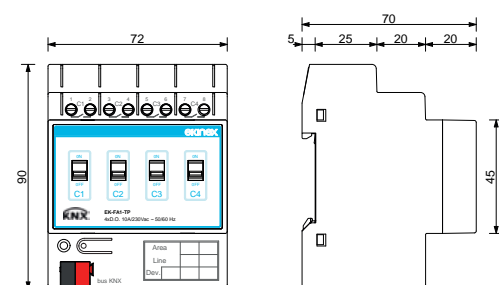

### Order information

Code	Package
EK-FA1-TP	1 pcs.



### Configuration and commissioning

By means of ETS5 software or later versions  
Application program **APEKFA1TP##.knxprod**  
(download from [www.ekinex.com](http://www.ekinex.com))



### Documentation

For more information, see the **STEKFA1TP\_EN.pdf**  
technical sheet available for download from [www.ekinex.com](http://www.ekinex.com)



## 8-fold binary output

ACTUATORS

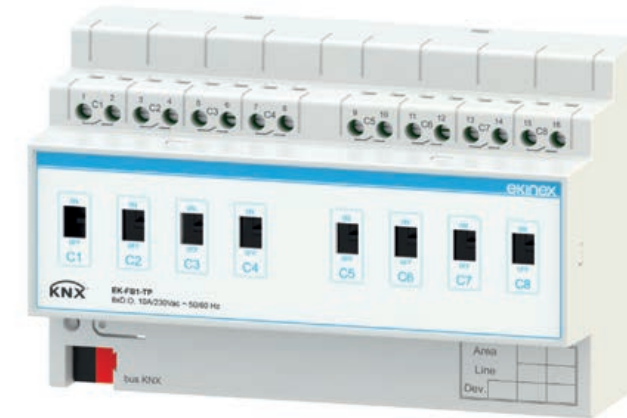

### Description

The Ekinex® EK-FB1-TP binary output allows to command 8 groups of loads independently; to this purpose, the device has outputs fitted with potential-free relays. The device's latching relays guarantee the upkeep of command status even in the case of bus power failures. The front levers indicate the status of each output channel and, in case of emergency, allow manual command (by means of a tool) of the loads. The device integrates a KNX bus communication module and is realized for mounting on a standard 35 mm DIN-rail. The device is supplied by the KNX bus and does not require auxiliary power supply.

### Main features

- Plastic casing
- Frontal programming pushbutton and LED
- Connection to bus line with KNX terminal block
- Connection of outputs with screw terminals
- Overvoltage class III (according to EN 60664-1)
- Classification climatic 3K5 and mechanical 3M2 (according to EN 50491-2)
- Pollution degree 2 (according to IEC 60664-1)
- Installation on 35 mm rail (according to EN 60715)
- 8 modular units (1 MU = 18 mm)
- IP20 protection degree (installed device)
- Weight 385 g

### Technical data

#### Power supply

- 30 Vdc voltage by KNX bus
- Current consumption from bus < 12 mA
- Power from bus 360 mW

#### Outputs

- 4 latch relays
- Nominal voltage (U<sub>n</sub>): 100-230Vac, 50/60Hz
- Nominal current (I<sub>n</sub>): max 10 A (both @100Vac and @230Vac)
- Switched power: 1000W @100Vac - 2200 W @230Vac

### Products included

Delivery includes a terminal block for connection to the bus.

### Dimensions [mm]

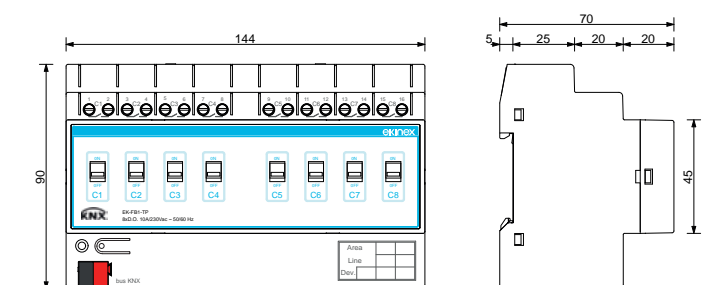

### Order information

Code	Package
EK-FB1-TP	1 pcs.



### Configuration and commissioning

By means of ETS5 software or later versions  
Application program **APEKFB1TP##.knxprod**  
(download from [www.ekinex.com](http://www.ekinex.com))



### Documentation

For more information, see the **STEKFB1TP\_EN.pdf**  
technical sheet available for download from [www.ekinex.com](http://www.ekinex.com)





## 8-fold binary output/ 4-fold blind actuator

ACTUATORS

### Description

The Ekinex® EK-FE1-TP binary output / blind actuator allows to command 8 groups of loads or control 4 drives for motorised blinds independently. The device is fitted with membrane pushbuttons for manual command (even in the absence of bus power) and LED's for status indication: a pushbutton allows to switch between automatic and manual operation modes. The device integrates a KNX bus communication module and is realized for mounting on a standard 35 mm DIN-rail. The device is supplied by the KNX bus and requires an additional 230 Vac power supply to operate.

### Main features

- Plastic casing
- Frontal programming pushbutton and LED
- Membrane keyboard with LED's for status indication
- Pushbutton for switching operating mode (normal / programming)
- Connection to bus line with KNX terminal block
- Connection of outputs and 230 Vac power supply with screw terminals
- Overvoltage class III (according to EN 60664-1)
- Classification climatic 3K5 and mechanical 3M2 (according to EN 50491-2)
- Pollution degree 2 (according to IEC 60664-1)
- Installation on 35 mm rail (according to EN 60715)
- 4 modular units (1 MU = 18 mm)
- IP20 protection degree (installed device)
- Weight 315 g

### Technical data

#### Power supply

- Voltage auxiliary 100-230 Vac 50/60 Hz
- Voltage control section 30 Vdc by KNX bus
- Current consumption from bus < 10 mA
- Power on bus < 240 mW

#### Outputs

- Number: 8 or 4 independent channels (depending on device use)
- Nominal voltage ( $U_n$ ): 100-230 Vac 50/60Hz
- Nominal current ( $I_n$ ): max 16 (10) A (both @100Vac and @230Vac)
- Max. switched power: max 4000 VA @250Vac

### Products included

Delivery includes a terminal block for connection to the bus.

### Dimensions [mm]

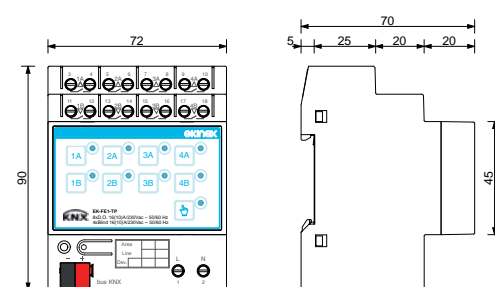

### Order information

Code	Package
EK-FE1-TP	1 pcs.



### Configuration and commissioning

By means of ETS5 software or later versions  
Application program **APEKFE1TP##.knxprod**  
(download from [www.ekinex.com](http://www.ekinex.com))



### Documentation

For more information, see the **STEKFE1TP\_EN.pdf**  
technical sheet available for download from [www.ekinex.com](http://www.ekinex.com)

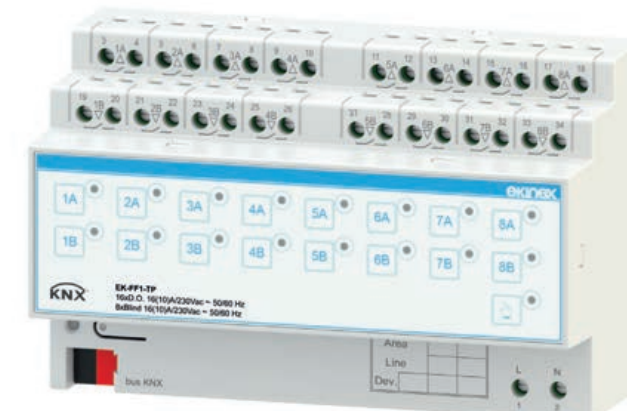

## 16-fold binary output/ 8-fold blind actuator

ACTUATORS

### Description

The Ekinex® EK-FF1-TP binary output / blind actuator allows to command 16 groups of loads or control 8 drives for motorised blinds independently. The device is fitted with membrane pushbuttons for manual command (even in the absence of bus power) and LED's for status indication: a pushbutton allows to switch between automatic and manual operation modes. The device integrates a KNX bus communication module and is realized for mounting on a standard 35 mm DIN-rail. The device is supplied by the KNX bus and requires an additional 230 Vac power supply to operate.

### Main features

- Plastic casing
- Frontal programming pushbutton and LED
- Membrane keyboard with LED's for status indication
- Pushbutton for switching operating mode (normal / programming)
- Connection to bus line with KNX terminal block
- Connection of outputs and 230 Vac power supply with screw terminals
- Overvoltage class III (according to EN 60664-1)
- Classification climatic 3K5 and mechanical 3M2 (according to EN 50491-2)
- Pollution degree 2 (according to IEC 60664-1)
- Installation on 35 mm rail (according to EN 60715)
- 8 modular units (1 MU = 18 mm)
- IP20 protection degree (installed device)
- Weight 595 g

### Technical data

#### Power supply

- Voltage auxiliary 100-230 Vac 50/60 Hz
- Voltage control section 30 Vdc by KNX bus
- Current consumption from bus < 10 mA
- Power on bus < 240 mW

#### Outputs

- Number: 16 or 8 independent channels (depending on device use)
- Nominal voltage ( $U_n$ ): 100-230 Vac 50/60Hz
- Nominal current ( $I_n$ ): max 16 (10) A (both @100Vac and @230Vac)
- Max. switched power: max 4000 VA @250Vac

### Products included

Delivery includes a terminal block for connection to the bus.

### Dimensions [mm]

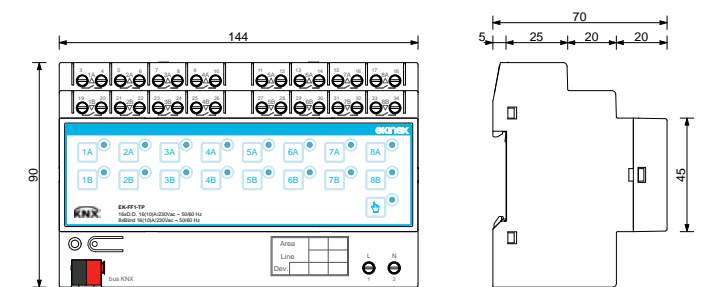

### Order information

Code	Package
EK-FF1-TP	1 pcs.



### Configuration and commissioning

By means of ETS5 software or later versions  
Application program **APEKFF1TP##.knxprod**  
(download from [www.ekinex.com](http://www.ekinex.com))



### Documentation

For more information, see the **STEKFF1TP\_EN.pdf**  
technical sheet available for download from [www.ekinex.com](http://www.ekinex.com)





# I/O modules

DIN-RAIL MOUNT MODULES

EK-HU1-TP  
Input/output module  
for office applications

EK-HO1-TP  
Input/output module  
for hotel applications



30 Vdc power supply from bus	•	•
Auxiliary power supply 230 Vac 50/60 Hz	•	•
Analog Inputs	1	1
Freely programmable inputs as analogue or binary inputs	1	1
Binary inputs	3	9
Relay outputs 5 (3) A	2	4
Relay outputs 5 (3) A, for fan control	3	3
Relay outputs 16 (10) A, for heating and cooling valve control	-	2
Relay outputs for electric lock control	1	1
Relay outputs 16 (10) A	-	6
0-10 Vdc output	1	1
Membrane keypad for manual control of outputs	•	•
Function for ON/OFF lighting control	1	6
Function for roller shutters / awnings control	1	2
Function for electric strike control	-	•
Temperature control function	•	•
Switch-off scenarios and courtesy lights function	-	•
Logical functions	•	•



## Description

The Ekinex® EK-HU1-TP module allows to manage all functions of an office or a open-space zone: lighting, temperature control, shades and input/output indications. The device is equipped with membrane keys for manual control and status indication LEDs: a pushbutton allows to switch mode from automatic to manual and vice versa. The device integrates a KNX bus communication module and is intended for mounting on a 35 mm standard DIN-rail. It is supplied by the KNX bus: in order to be operational it also requires a 230 Vac voltage.

## Main features

- Plastic casing
- Frontal programming pushbutton and LED
- Membrane keypad with LED indication of the input status
- Pushbutton for automatic/manual mode switch
- Connection to bus line with KNX terminal block
- Screw terminal blocks for connecting inputs, outputs and 230 Vac power supply
- 3K5 climatic and 3M2 mechanic classification (according to EN 50491-2)
- Overvoltage class III (according to EN 60664-1)
- Pollution level 2 (according to IEC 60664-1)
- Mounting on 35 mm standard DIN-rail (according to EN 60715)
- 8 modular units (1 UM = 18 mm)
- Protection degree IP20 (device installed)
- Weight 595 g

## Technical data

### Power supply

- Load power supply 230 Vac 50/60 Hz: electrical lock 12-24 V
- Power supply (electronics) 30 Vdc via KNX bus
- Current consumption by bus < 10 mA
- Power on bus < 240 mW

## Order information

Code	Package
EK-HU1-TP	1 pcs.

# Input/output module for office applications

I/O MODULES

## Inputs

- 1 analog for NTC temperature sensor (thermostat function)
- 4 digital

## Outputs

- 10 digital of which:
  - 3 general purpose
  - 2 (paired) for blind or shade control
  - 5 fancoil: 3 for fan speed (3 speeds) and 2 for controlling electrothermal actuators on hot/cold valves
- 1 analog 0-10V for fan speed control

## Products included

Delivery includes a terminal block for connection to the bus.

## Dimensions [mm]

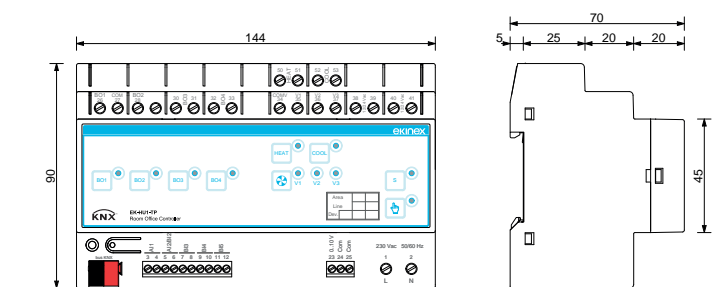

## Configuration and commissioning

By means of ETS5 software or later versions  
Application program: **APEKHU1TP##.knxprod**  
(## = version, downloadable from [www.ekinex.com](http://www.ekinex.com))



## Documentation

For more information, see the **STEKHU1TP\_EN.pdf** technical sheet available for download from [www.ekinex.com](http://www.ekinex.com)



# Input/output module for hotel applications

I/O MODULES

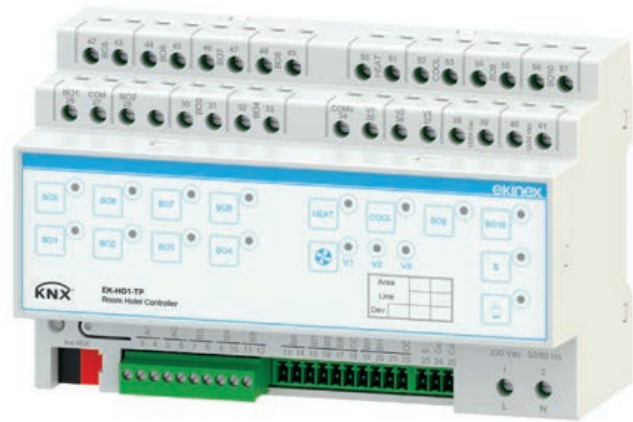

### Description

The Ekinex® EK-H01-TP module allows to manage all functions of a hotel room: lighting, temperature control, shades and input/output indications. The device is equipped with membrane keys for manual control and status indication LEDs: a pushbutton allows to switch mode from automatic to manual and vice versa. The device integrates a KNX bus communication module and is intended for mounting on a 35 mm standard DIN-rail. It is supplied by the KNX bus; in order to be operational it also requires a 230 Vac voltage.

### Main features

- Plastic casing
- Frontal programming pushbutton and LED
- Membrane keypad with LED indication of the input status
- Pushbutton for automatic/manual mode switch
- Connection to bus line with KNX terminal block
- Screw terminal blocks for connecting inputs, outputs and 230 Vac power supply
- 3K5 climatic and 3M2 mechanic classification (according to EN 50491-2)
- Overvoltage class III (according to EN 60664-1)
- Pollution level 2 (according to IEC 60664-1)
- Mounting on 35 mm standard DIN-rail (according to EN 60715)
- 8 modular units (1 UM = 18 mm)
- Protection degree IP20 (device installed)
- Weight 595 g

### Technical data

#### Power supply

- Load power supply 230 Vac 50/60 Hz; electrical lock 12-24 V
- Power supply (electronics) 30 Vdc via KNX bus
- Current consumption by bus < 10 mA
- Power on bus < 240 mW

### Inputs

- 1 analog for NTC temperature sensor (thermostat function)
- 1 configurable as analog or digital
- 10 digital of which:
  - 4 general purpose
  - 2 door or window opening contact
  - 1 pushbutton with pulling call for assistance/emergency
  - 1 badge contact
  - 2 pushbuttons «Do not disturb» e «Please make room»

### Outputs

- 15 digital of which:
  - 3 general purpose
  - 3 for indications: «guest in the room», «room assigned», busy room or emergency»
  - 2 (paired) for blind or shade control
  - 1 for courtesy light control
  - 5 for fancoil: 3 for fan speed (3 speeds) and 2 for controlling electrothermal actuators on hot/cold valves
  - 1 digital room contactor and auxiliaries
- 1 powered at 12/24 Vac for controlling an electric lock
- 1 analog 0-10 V for fan speed control

### Products included

Delivery includes a terminal block for connection to the bus.

### Dimensions [mm]

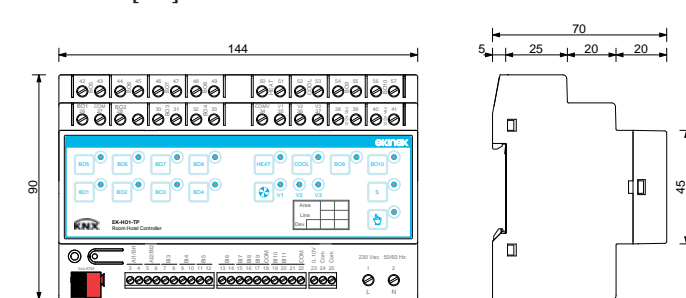

### Configuration and commissioning

By means of ETS5 software or later versions  
Application program: **APEKH01TP##.knxprod**  
(## = version, downloadable from [www.ekinex.com](http://www.ekinex.com))



### Documentation

For more information, see the **STEKH01TP\_EN.pdf** technical sheet available for download from [www.ekinex.com](http://www.ekinex.com)



# Dimmers

DIN-RAIL MOUNT MODULES

EK-GA1-TP  
2-fold dimming actuator



EK-GC1-TP  
4-fold RGBW LED dimmer



EK-GF1-TP  
4-fold 0-10 V actuator



ON/OFF switching of single or groups of lighting device	•	•	•
Brightness regulation and adjusting the light intensity	•	•	•
Logical gates and forced mode for each channel	•	•	•
Manual control by membrane pushbuttons	•	•	•
Status feedback of output channels through LEDs	•	•	•
Block function for each channel	•	•	•
Without auxiliary power supply	•	•	•
Time scheduling: switching delay for on and off, staircase lighting function	•	•	•
Integration in scenarios	•	•	•
Operating hours counter configurable via bus	•	•	•
Fade adjustable ramps	•	•	•
RGB / HSV operating mode	-	•	•
Mounting on standard 35 mm rail (EN 60715)	•	•	•

# DALI Dimmers

DIN-RAIL MOUNT MODULES

EK-GH1-DL  
1 channel DALI Dimmer



EK-GL1-DL  
4 channels DALI Dimmer



EK-GO1-DL  
4 channels DALI Dimmer 230 Vac



Memory function	•	•	•
Brightness adjustment until complete switch-off	•	•	•
Local control input	•	•	-
D-PWM modulation with adjustable frequency (300 / 600 / 1200 Hz)	•	•	•
Adjustable dimming curve: linear / quadratic / exponential	•	•	•
Smooth switching on and off	•	•	•
Optimised output curve	•	•	•
Screw terminals for DALI bus, control, power supply and LED source	•	•	•
Device power supply: 10.8 Vdc (min) ... 52.8 Vdc (max)	•	•	-
Device power supply: 230 Vac 50 Hz	-	-	•
Device power supply: 10.8 Vdc (min) ... 26.4 Vdc (max)	-	-	-



## 2-fold dimming actuator

DIMMERS

### Description

The Ekinex® EK-GA1-TP dimming actuator allows to command and regulate the light intensity of 2 groups of lighting devices. The device is suitable for the control of resistive, inductive and capacitive loads powered with 230 Vac. Different types of loads can be connected to different channels. The device is fitted with membrane pushbuttons for manual command and LEDs for status indication; a pushbutton allows the switching between automatic or manual operation modes. The device integrates a KNX bus communication module and is realised for mounting on a standard 35 mm DIN-rail. The device is powered by the KNX bus and requires an additional 230 Vac power supply to operate the loads.

### Main features

- Plastic casing
- Frontal programming pushbutton and LED
- Membrane keyboard with LEDs for status indication of outputs
- Pushbutton for switching operating mode (normal / programming)
- Connection to bus line with KNX terminal block
- Connection of outputs and 230 Vac power supply with screw terminals
- Installation on 35 mm rail (according to EN 60715)
- 4 modular units (1 MU = 18 mm)
- IP20 protection degree (installed device)
- Weight 160 g

### Technical data

#### Power supply

- Voltage (loads): 230 Vac 50/60 Hz
- Voltage (electronics): 30 Vdc by KNX bus
- Current consumption from bus: < 13 mA
- Max. power from bus: 320 mW

#### Outputs

- Number: 2
- Max. controlled power: 300 W
- Min. controlled power: 10 W

### Products included

Delivery includes a terminal block for connection to the bus.

### Dimensions [mm]

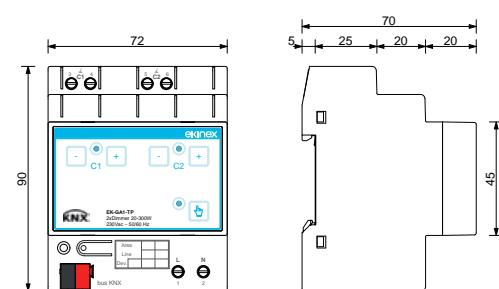

### Order information

Code	Package
EK-GA1-TP	1 pcs.



### Configuration and commissioning

By means of ETS5 software or later versions  
Application program **APEKGA1TP#.#.knxprod**  
(download from [www.ekinex.com](http://www.ekinex.com))



### Documentation

For more information, see the **STEKGA1TP\_EN.pdf**  
technical sheet available for download from [www.ekinex.com](http://www.ekinex.com)



## 4-fold RGBW LED dimmer

DIMMERS

### Description

The Ekinex® EK-GC1-TP 4-fold RGBW LED dimmer allows to regulate independently the light intensity emitted by 4 LED strips at 12/24 Vdc or, alternatively, to regulate the light intensity and the colour emitted by a RGB or RGBW LED strip. The device is suitable for use with LED strips powered at constant voltage. The selection of the colour can be made optionally in HSV or RGB mode. Scenarios, predefined sequences, sequence repetition and random functions are available; the dimming speed and the holding time are programmable. The device is fitted with membrane pushbuttons for manual command and LEDs for status indication; a pushbutton allows the switching between automatic or manual operation modes. The device integrates a KNX bus communication module and is realised for mounting on a standard 35 mm DIN-rail. The device is powered by the KNX bus and requires an additional 12...30 Vdc to supply the controlled loads.

### Main features

- Plastic casing
- Frontal programming pushbutton and LED
- Membrane keyboard with LEDs for status indication of outputs
- Pushbutton for switching operating mode (normal / programming)
- CH pushbutton for individual or simultaneous channels control
- HSV / RGB pushbutton colour control mode
- Auxiliary dry contact to disconnect load power supply during standby
- Connection to bus line with KNX terminal block
- Connection of outputs and 12-30 Vdc power supply with screw terminals
- Installation on 35 mm rail (according to EN 60715)
- 4 modular units (1 MU = 18 mm)
- IP20 protection degree (installed device)

### Technical data

#### Power supply

- Voltage (strip LED): max 30 Vdc, 16 A
- Voltage (control): 30 Vdc by KNX bus

#### Outputs

- Number: 4
- Load current for each channel: 4 A

### Products included

Delivery includes a terminal block for connection to the bus.

### Dimensions [mm]

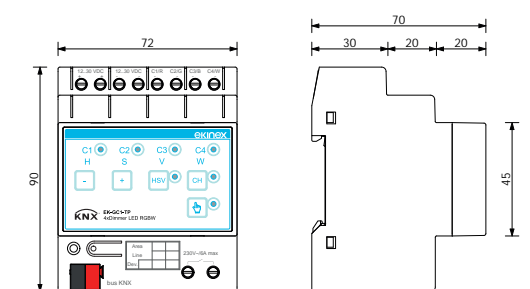

### Order information

Code	Package
EK-GC1-TP	1 pcs.



### Configuration and commissioning

By means of ETS5 software or later versions  
Application program **APEKGC1TP#.#.knxprod**  
(download from [www.ekinex.com](http://www.ekinex.com))



### Documentation

For more information, see the **STEKGC1TP\_EN.pdf**  
technical sheet available for download from [www.ekinex.com](http://www.ekinex.com)







## 4-fold 0-10 V actuator

DIMMERS

### Description

The Ekinex® 4-fold 0-10 V actuator EK-GF1-TP can be used as 0-10 V control output device or, alternatively, for controlling dimmable LED power supply units. When used for LED controlling, the selection of the colour can be made optionally in HSV or RGB mode. Scenarios, predefined sequences, sequence repetition and random functions are available; the dimming speed and the holding time are programmable. The device is fitted with membrane pushbuttons for manual command and LEDs for status indication; a pushbutton allows the switching between automatic or manual operation modes. The device integrates a KNX bus communication module and is realised for mounting on a standard 35 mm DIN-rail. The device is powered by the KNX bus.

### Main features

- Plastic casing
- Frontal programming pushbutton and LED
- Membrane keyboard with LEDs for status indication of outputs
- Pushbutton for switching operating mode (normal / programming)
- CH pushbutton for individual or simultaneous channels control
- HSV / RGB pushbutton colour control mode
- Connection to bus line with KNX terminal block
- Connection of outputs with screw terminals
- Installation on 35 mm rail (according to EN 60715)
- 4 modular units (1 MU = 18 mm)
- IP20 protection degree (installed device)

### Technical data

#### Power supply

- Voltage (control): 30 Vdc by KNX bus
- Rated output stage supply voltage: 100-230Vac, 50/60Hz max 5W

#### Outputs

- Number: 4
- Range: 0-10 V or 1-10V
- Max. current for each channel: 50 mA

### Products included

Delivery includes a terminal block for connection to the bus and a terminal block for connection to the auxiliary power supply.

### Dimensions [mm]

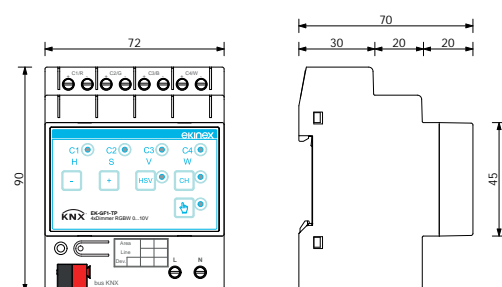

### Configuration and commissioning

By means of ETS5 software or later versions  
Application program **APEKGF1TP##.knxprod**  
(download from [www.ekinex.com](http://www.ekinex.com))



### Documentation

For more information, see the **STEKGF1TP\_EN.pdf** technical sheet available for download from [www.ekinex.com](http://www.ekinex.com)



## 1-channel DALI dimmer

DALI DIMMER

### Description

The 1-channel DALI dimmer EK-GH1-DL allows lighting control of dimmable LED light sources thanks to a KNX (TP) button connected via DALI/KNX Gateway or by another local control device, directly connected to the dedicated input selectable among normally open button, 0 to 10V analog input, 1 to 10V analog input or 10 kΩ potentiometer. The device has a built-in DALI communication bus and it requires a 12, 24 or 48 Vdc auxiliary power supply.

### Main features

- Plastic case
- Device for two modular units (1 MU = 18 mm)
- Mounting on DIN 35 mm profile rail (EN 60715)
- Degree of protection IP10 (once the device has been installed)

### Functions

- Memory function
- Brightness control dim-to-dark
- Minimum brightness level: 0,1% (1% in push)
- Pulse Width Modulation with configurable frequency (300/600/1200 Hz)
- Adjustable dimming curves (linear dimming curves, logarithmic dimming curves, square law dimming curves)
- Soft switching
- Optimized output curve

### Configurations

- 6 pins dip switch to set the dimming curve, the input source (local controls) and the dimming frequency

### Connections

- Screw terminals for DALI bus, command, power supply and LED source
- Maximum length of the connection between dimmer-driver and command < 10 m

### Technical data

- Device power supply: 10.8 Vdc (min) ... 52.8 Vdc (max)
- Power consumption (at 40°C): 78 W (12 V), 156 W (24 V), 312 W (48 V)
- Control output: 1 x 6.5 A at 55°C, 8 A (peak)

### Order information

Code	Packaging
EK-GH1-DL	1 pz.

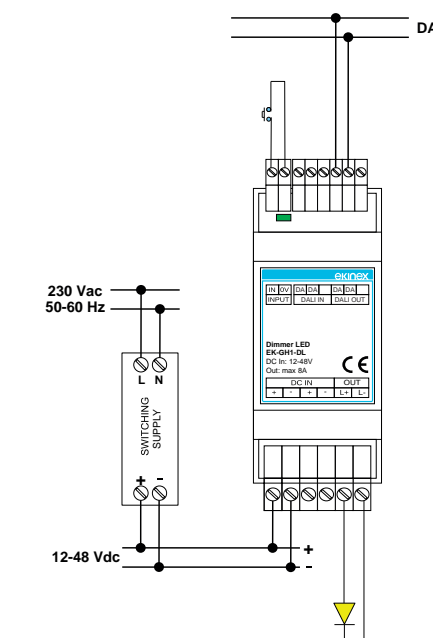

Thanks to the dip-switch, it is possible to set the dimming curve, the type of input (local controls) and the dimming frequency.

### Esempi di configurazione dei comandi locali

Tipologia del Comando	Descrizione	Connessioni	Settaggio
Pulsante	Pulsante N.A. senza memoria		
	Pulsante N.A. con memoria		
0-10V	Input Analogico 0-10V		
1-10V	Input Analogico 1-10V & Potenziometro		



### Documentation

For more information see the data sheet **STEKGH1DL\_IT.pdf**, download da [www.ekinex.com](http://www.ekinex.com)





## 4-channels DALI dimmer

DALI DIMMER

### Description

The 4-channel DALI dimmer EK-GL1-DL allows dim-to-warm lighting control of dynamic white, RGB and RGBW of dimmable LED light sources thanks to a KNX (TP) buttons connected via DALI/KNX Gateway or by other local control devices, directly connected to dedicated inputs selectable among normally open buttons, 0 to 10V analog inputs, 1 to 10V analog inputs or 10 kΩ potentiometers. The device has a built-in DALI communication bus and it requires a 12, 24 or 48 Vdc auxiliary power supply.

### Main features

- Plastic case
- Device for four modular units (1 MU = 18 mm)
- Mounting on DIN 35 mm profile rail (EN 60715)
- Degree of protection IP10 (once the device has been installed)

### Functions

- Memory function
- Brightness control dim-to-dark
- Minimum brightness level: 0,1% (1% in push)
- Pulse Width Modulation with configurable frequency (300/600/1200 Hz)
- Adjustable dimming curves (linear dimming curves, logarithmic dimming curves, square law dimming curves)
- Soft switching
- Optimized output curve

### Configurations

- 12 pins dip switch to set the kind of LED load, parallel outputs, the dimming curve, the input source (local controls) and the dimming frequency

### Connections

- Screw terminals for DALI bus, command, power supply and LED source
- Maximum length of the connection between dimmer-driver and command < 10 m

### Technical data

- Device power supply: 10.8 Vdc (min) ... 52.8 Vdc (max)
- Control outputs: 4 x (max) 5 A, 1 x (max) 20 A
- Current consumption max. 2.8 A

### Order information

Code	Packaging
EK-GL1-DL	1 pz.

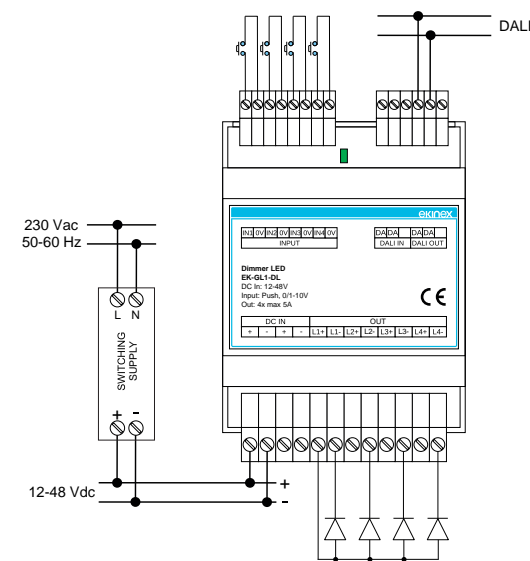

Thanks to the dip-switch it is possible to set a wide range of configurations regarding LED load type, parallel outputs, map, dimming curve, input type (local controls) and dimming frequency.

Load type	Description	Connection (total current 0 - 15A max)	Connection (total current 0 - 25A max)	Settings
White	White, up to 4 loads	[Diagram]	[Diagram]	[Icon]
	White, parallel outputs with the highest current, single channel at 10 A max or 20 A max (Macro dimmer)	[Diagram]	[Diagram]	[Icon]
Dynamic white	Dynamic white, up to 2 loads	[Diagram]	[Diagram]	[Icon]
	Dynamic white, pair of parallel outputs with the highest current	[Diagram]	[Diagram]	[Icon]
RGB	RGB	[Diagram]	[Diagram]	[Icon]
RGBW	RGBW	[Diagram]	[Diagram]	[Icon]



### Documentation

For more information see the data sheet [STEKGL1DL\\_IT.pdf](#), download from [www.ekinex.com](http://www.ekinex.com)



## 4-channels DALI dimmer 230 Vac

DALI DIMMER

### Descrizione

The 4-channel DALI dimmer EK-G01-DL allows lighting control of dimmable LED and halogen light sources thanks to a KNX (TP) button connected via DALI/KNX Gateway or by another device compatible with DALI protocol. The 4 phase-cut outputs (trailing edge) at 230 V are suitable for R-C loads. The device has a built-in DALI communication bus, it is powered by 230 Vac mains voltage and it does not require an auxiliary power supply.

### Main features

- Plastic case
- Device for eight modular units (1 MU = 18 mm)
- Mounting on DIN 35 mm profile rail (EN 60715)
- Degree of protection IP10 (once the device has been installed)

### Functions

- Memory function
- Brightness control
- Adjustable minimum brightness
- Soft switching
- Optimized dimming curve

### Configurations

- Simplified method: by connecting one ballast at a time, each one will get the address progressively from 0 to 63
- Random address allocation: by connecting all the ballasts at the same time, each one will get a random address

### Connections

- Spring terminals for DALI bus, command, power supply and LED source
- Maximum length of the connection between dimmer-driver and command < 10 m

### Technical data

- Device power supply: 230 Vac 50 Hz
- Max. power 4 x 200W
- Dimming range 0-100 % (depending on the type of source)

### Order information

Code	Packaging
EK-G01-DL	1 pz.

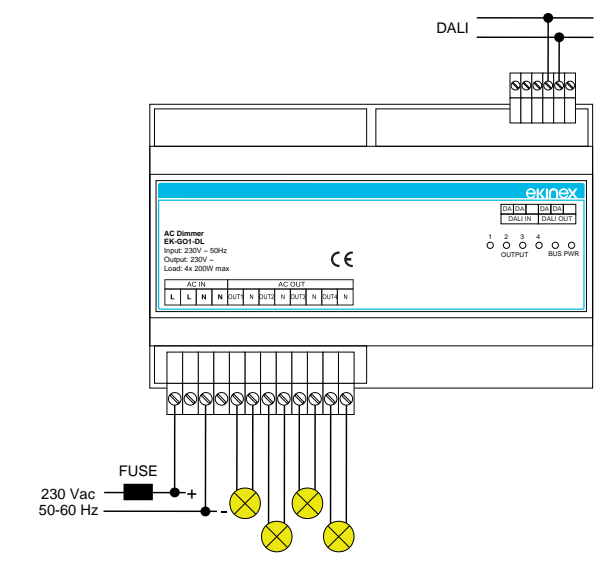

### Documentation

For more information see the data sheet [STEKGL1DL\\_IT.pdf](#), download from [www.ekinex.com](http://www.ekinex.com)



# Thermoregulation and PLC

## DIN-RAIL MOUNT MODULES

EK-HA1-TP Fan-coil actuator / controller 3-speed fan control	EK-HB1-TP Fan-coil actuator / controller 0-10 V fan control	EK-HC1-TP Fan-coil actuator / controller full version	EK-HE1-TP 8-fold actuator / controller for electrothermal valve drives	EK-HH1-TP Mixing actuator
---	--	--	--	------------------------------



Power 30 Vdc from KNX bus	•	•	•	•	•
Auxiliary power supply 230 Vac 50/60 Hz	•	•	•	•	•
Analog input (passive temperature sensors 10 kΩ NTC at 25°C)	•	•	•	-	•
Digital input (potential-free)	•	•	•	-	•
Output relays	•	•	•	-	•
Output triac relays	-	-	-	•	•
Output 0-10V (high impedance signal control)	-	•	•	-	•
Membrane keyboard for manual/automatic control with status indication LEDs	-	-	•	-	•
LCD-display	-	-	-	-	•
2-pipe hydraulic distribution systems applications	•	•	•	•	-
4-pipe hydraulic distribution systems applications	-	-	•	•	-
Actuator	•	•	•	•	-
Internal controller	•	•	•	•	•
Air flow terminal: ventilation	•	•	•	-	-
Air flow terminal: convector	•	•	•	-	-
Air flow terminal: fan-coil	•	•	•	-	-
Air flow terminal: fan-coil + 2° electrical stage	-	-	•	-	-
Underfloor and ceiling systems distribution	-	-	-	•	•
Underfloor and ceiling mixing valve systems	-	-	-	-	•
Mounting on standard 35 mm rail (EN 60715)	•	•	•	•	•

EK-B01-TP-RMA  
Modbus / KNX interface for RDZ  
air handling units



Power 30 Vdc from KNX bus	•
Mounting on standard 35 mm rail (EN 60715)	•
<b>Supported RDZ air handling units</b>	
Mechanical ventilation with heat recovery	CHR Family WHR Family
Air renewal with dehumidification	UAP PDC Family UC Family
LED signalling Modbus traffic	•
Device status LED	•
LED error indication	•
KNX programming LED	•
Programming button	•





## Fancoil actuator / controller 3-speed fan control

THERMOREGULATION

### Description

The Ekinex® EK-HA1-TP fancoil actuator / controller allows to control a fan coil unit for the air conditioning of a room. The device can perform the function of simple actuator in combination with a KNX room thermostat or that of actuator / controller with acquisition of the temperature value by a KNX room sensor or a probe connected to an analog input. The device is suitable for 2-pipe hydraulic distribution systems with ON / OFF control of one electrothermal shut-off valve actuator and a 3-speed fan. The outputs not used to control the fan coil unit can be configured as binary output channels for different functions. The device is equipped with 2 inputs freely configurable as analog or digital. The device integrates a KNX bus communication module and is realized for mounting on a standard 35 mm DIN-rail. The device is supplied by the KNX bus and requires an additional 230 Vac power supply to operate.

### Main features

- Plastic casing
- Frontal programming pushbutton and LED
- Connection to bus line with KNX terminal block
- Connection of inputs, outputs and 230 Vac power supply with screw terminals
- Classification climatic 3K5 and mechanical 3M2 (according to EN 50491-2)
- Overvoltage class III (according to EN 60664-1)
- Pollution degree 2 (according to IEC 60664-1)
- 35 mm rail mounting (according to EN 60715)
- 4 modular units (1 MU = 18 mm)
- IP20 protection degree (installed device)
- Weight 175 g

### Technical data

#### Power supply

- Voltage (loads) 230 Vac 50/60 Hz
- Voltage (electronics) 30 Vdc by KNX bus

#### Inputs

- 2 freely configurable for passive temperature sensors (10 k $\Omega$  NTC at 25°C) or as potential-free binary inputs

#### Outputs

- 3 interlocked relay outputs to control a 3-speed fan (or configurable as binary outputs for different applications)
- 1 relay SPST (single pole, single throw) to control an ON / OFF valve (in 2-pipe hydraulic distribution systems)

### Products included

Delivery includes a terminal block for connection to the bus.

### Dimensions [mm]

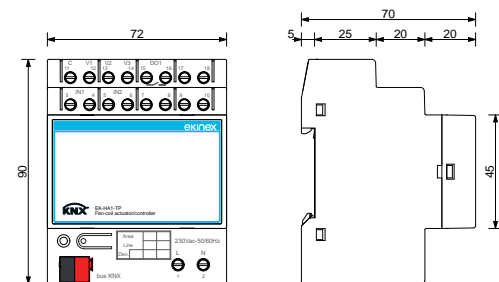

### Order information

Code	Package
EK-HA1-TP	1 pcs.



### Configuration and commissioning

By means of ETSS software or later versions  
Application program **APEKHA1TP##.knxprod**  
(download from [www.ekinex.com](http://www.ekinex.com))



### Documentation

For more information, see the **STEKHA1TP\_EN.pdf**  
technical sheet available for download from [www.ekinex.com](http://www.ekinex.com)



## Fancoil actuator / controller 0-10 V fan control

THERMOREGULATION

### Description

The Ekinex® EK-HB1-TP fancoil actuator / controller allows to control a fan coil unit for the air conditioning of a room. The device can perform the function of simple actuator in combination with a KNX room thermostat or that of actuator / controller with acquisition of the temperature value by a KNX room sensor or a probe connected to an analog input. The device is suitable for 2-pipe hydraulic distribution systems with ON / OFF control of one electrothermal shut-off valve actuator and a fan with brushless motor. The outputs not used to control the fan coil unit can be configured as binary output channels for different functions. The device is equipped with 2 inputs freely configurable as analog or digital. The device integrates a KNX bus communication module and is realized for mounting on a standard 35 mm DIN-rail. The device is supplied by the KNX bus and requires an additional 230 Vac power supply to operate.

### Main features

- Plastic casing
- Frontal programming pushbutton and LED
- Connection to bus line with KNX terminal block
- Connection of inputs, outputs and 230 Vac power supply with screw terminals
- Classification climatic 3K5 and mechanical 3M2 (according to EN 50491-2)
- Overvoltage class III (according to EN 60664-1)
- Pollution degree 2 (according to IEC 60664-1)
- 35 mm rail mounting (according to EN 60715)
- 4 modular units (1 MU = 18 mm)
- IP20 protection degree (installed device)
- Weight 175 g

### Technical data

#### Power supply

- Voltage (loads) 230 Vac 50/60 Hz
- Voltage (electronics) 30 Vdc by KNX bus

#### Inputs

- 2 freely configurable for passive temperature sensors (10 k $\Omega$  NTC at 25°C) or as potential-free binary inputs

#### Outputs

- 1 to control a brushless motor driven fan with 0-10 V signal
- 1 relay SPST (single pole, single throw) to control an ON / OFF valve (in 2-pipe hydraulic distribution systems)

### Products included

Delivery includes a terminal block for connection to the bus.

### Dimensions [mm]

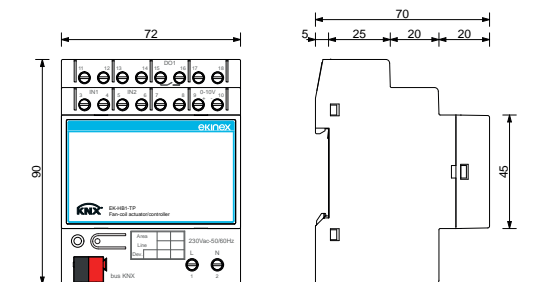

### Order information

Code	Package
EK-HB1-TP	1 pcs.



### Configuration and commissioning

By means of ETSS software or later versions  
Application program **APEKHB1TP##.knxprod**  
(download from [www.ekinex.com](http://www.ekinex.com))



### Documentation

For more information, see the **STEKHB1TP\_EN.pdf**  
technical sheet available for download from [www.ekinex.com](http://www.ekinex.com)





## Fancoil actuator / controller full version

THERMOREGULATION

### Description

The Ekinex® EK-HC1-TP fancoil actuator / controller allows to control a fan coil unit for the air conditioning of a room. The device can perform the function of simple actuator in combination with a KNX room thermostat or that of actuator / controller with acquisition of the temperature value by a KNX room sensor or a probe connected to an analog input. The device is suitable for 2 or 4-pipe hydraulic distribution systems with ON / OFF control of one or two electrothermal shut-off valve actuators and a 3-speed fan or a brushless motor driven fan. The outputs not used to control the fan coil unit can be configured as binary output channels for different functions. The device is equipped with 3 inputs freely configurable as analog or digital. The device is fitted with membrane pushbuttons for manual command and LED's for status indication: a pushbutton allows to switch between automatic and manual operation modes. The device integrates a KNX bus communication module and is realized for mounting on a standard 35 mm DIN-rail. The device is supplied by the KNX bus and requires an additional 230 Vac power supply to operate.

### Main features

- Plastic casing
- Frontal programming pushbutton and LED
- Membrane keyboard with LED's for status indication
- Pushbutton for switching operating mode (normal / programming)
- Connection to bus line with KNX terminal block
- Connection of inputs, outputs and 230 Vac power supply with screw terminals
- Classification climatic 3K5 and mechanical 3M2 (according to EN 50491-2)
- Overvoltage class III (according to EN 60664-1)
- Pollution degree 2 (according to IEC 60664-1)
- 35 mm rail mounting (according to EN 60715)
- 4 modular units (1 MU = 18 mm)
- IP20 protection degree (installed device)
- Weight 205 g

### Technical data

#### Power supply

- Voltage (loads) 230 Vac 50/60 Hz
- Voltage (electronics) 30 Vdc by KNX bus

#### Inputs

- 3 freely configurable for passive temperature sensors (10 kΩ NTC at 25°C) or as potential-free binary inputs

#### Outputs

- 1 to control a brushless motor driven fan with 0-10 V signal
- 3 interlocked relay outputs to control a 3-speed fan (or configurable as binary outputs for different applications)
- 2 relay SPST (single pole, single throw) to control two ON / OFF valves (in 2 or 4-pipe hydraulic distribution systems)

### Products included

Delivery includes a terminal block for connection to the bus.

### Dimensions [mm]

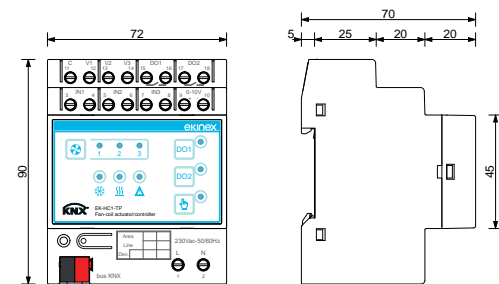

### Configuration and commissioning

By means of ETSS software or later versions  
Application program **APEKHC1TP##.knxprod**  
(download from [www.ekinex.com](http://www.ekinex.com))



### Documentation

For more information, see the **STEKHC1TP\_EN.pdf**  
technical sheet available for download from [www.ekinex.com](http://www.ekinex.com)



### Order information

Code	Package
EK-HC1-TP	1 pcs.



## 8-fold actuator / controller for electrothermal valve drives

THERMOREGULATION

### Description

The Ekinex® EK-HE1-TP actuator / controller allows to control electrothermal actuators or servomotors in hydronic systems for room heating and / or cooling. The device can perform the function of simple actuator in combination with one or more KNX room thermostats or that of actuator / controller with acquisition of the temperature value by one or more KNX sensors. The device is suitable for 2 or 4-pipe hydraulic distribution systems with ON / OFF control of electrothermal shut-off valve actuators. The device is fitted with membrane pushbuttons for manual command and LED's for status indication; a pushbutton allows to switch between automatic and manual operation modes. The device integrates a KNX bus communication module and is realized for mounting on a standard 35 mm DIN-rail. The device is supplied by the KNX bus and requires an additional 230 Vac power supply to operate.

### Main features

- Plastic casing
- Frontal programming pushbutton and LED
- Membrane keyboard with LED's for status indication
- Pushbutton for switching operating mode (normal / programming)
- Connection to bus line with KNX terminal block
- Connection of outputs and 230 Vac power supply with screw terminals
- Classification climatic 3K5 and mechanical 3M2 (according to EN 50491-2)
- Overvoltage class III (according to EN 60664-1)
- Pollution degree 2 (according to IEC 60664-1)
- 35 mm rail mounting (according to EN 60715)
- 4 modular units (1 MU = 18 mm)
- IP20 protection degree (installed device)
- Weight 160 g

### Technical data

#### Power supply

- Voltage (loads) 230 Vac 50/60 Hz
- Voltage (electronics) 30 Vdc by KNX bus

#### Outputs

- 8 TRIAC relays to control ON / OFF zone valve drives

### Products included

Delivery includes a terminal block for connection to the bus.

### Dimensions [mm]

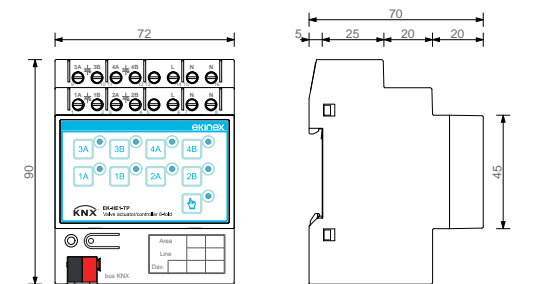

### Configuration and commissioning

By means of ETSS software or later versions  
Application program **APEKHE1TP##.knxprod**  
(download from [www.ekinex.com](http://www.ekinex.com))



### Documentation

For more information, see the **STEKHE1TP\_EN.pdf**  
technical sheet available for download from [www.ekinex.com](http://www.ekinex.com)





## Mixing actuator

THERMOREGULATION

### Description

The Ekinex® EK-HH1-TP mixing actuator allows the control of 3 floating points or 0-10 V servo-motor for mixing valves. The flow temperature of the conveying fluid can be set at a fixed point, with external climatic compensation and with external climatic compensation plus internal conditions recalibration. The regulation modes are selectable separately for heating and cooling. The device is particularly suitable for underfloor or ceiling heating and cooling radiant panels applications in combination with Ekinex® room thermostats with integrated temperature and humidity sensor. A 0-10 V output allows the remote setting of a heat pump temperature setpoint value. The startup function enables a radiant floors drying concrete phase according to EN 1264 standard. The membrane keyboard allows the manual command and includes LED's for status indication; the LCD-display allows displaying / setting of the main working parameters. The device integrates a KNX bus communication module and is realized for mounting on a standard 35 mm DIN-rail. The device is supplied by the KNX bus and requires an additional 230 Vac power supply to operate.

### Main features

- Plastic casing
- Frontal programming pushbutton and LED
- Membrane keyboard with LED's for status indication
- Pushbutton for switching operating mode (normal / programming)
- Connection to bus line with KNX terminal block
- Connection of inputs, outputs and 230 Vac power supply with screw terminals
- Classification climatic 3K5 and mechanical 3M2 (according to EN 50491-2)
- Overvoltage class III (according to EN 60664-1)
- Pollution degree 2 (according to IEC 60664-1)
- 35 mm rail mounting (according to EN 60715)
- 8 modular units (1 MU = 18 mm)
- IP20 protection degree (installed device)
- Weight 380 g

### Technical data

#### Power supply

- Voltage (loads) 230 Vac 50/60 Hz
- Voltage (electronics) 30 Vdc by KNX bus

#### Inputs

- 3 analogic exclusively for connection of NTC temperature sensors 10 kΩ at 25°C
- 2 configurable as analogic (exclusively for NTC temperature sensors 10 kΩ at 25°C) or digital (potential free)

#### Outputs

- 1 for control of a 3 point floating servomotor, 1 A, 250 Vac
- 1 for control of a servomotor with 0-10 V signal connection of high impedance input
- 3 for additional functions, relays 10(5) A, 250 Vac

### Products included

Delivery includes a terminal block for connection to the bus.

### Dimensions [mm]

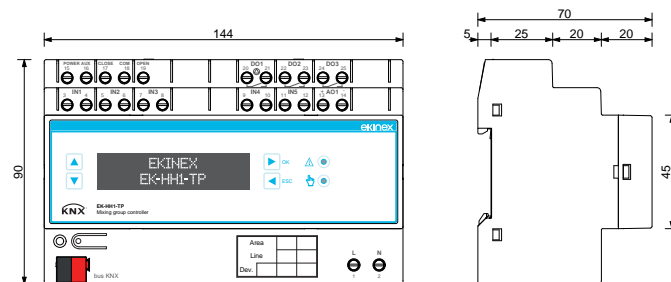

### Order information

Code	Package
EK-HH1-TP	1 pcs.



### Configuration and commissioning

By means of ETS5 software or later versions  
Application program **APEKHH1TP#.#.knxprod**  
(download from [www.ekinex.com](http://www.ekinex.com))



### Documentation

For more information, see the **STEKHH1TP\_EN.pdf**  
technical sheet available for download from [www.ekinex.com](http://www.ekinex.com)



## NTC 10 kΩ temperature sensors

TEMPERATURE CONTROL

### Description

Temperature sensors with NTC (Negative Temperature Coefficient, 10 kΩ ±1% at 25 °C, B = 3435) sensitive element for temperature measurement, to be used in combination with Ekinex® KNX devices equipped with an analog input (or configurable as [AI]) for temperature measurement.

### Characteristics and Technical data

#### Outdoor version (EK-STE-10K-3435)

- Sensitive element with high IP protection degree casing
- Cable gland (connecting cable not included in delivery)
- Working conditions:
  - operating temperature: -40°C...+100°C
  - relative humidity: 0...100%

#### Immersion version (EK-STI-10K-3435)

- Sensitive element with INOX cylinder casing
- Two-wire connecting cable (length 1,5 m)
- Operating temperature: -40°C...+105°C

#### Contact version (EK-STC-10K-3435)

- Brass toecap
- Two-wire connecting cable (length 1,5 m)
- Operating temperature: -40°C...+100°C

#### Air mass version (EK-STL-10K-3435)

- Sensor printed directly on the connecting cable
- Two-wire connecting cable (length 1,5 m)
- Operating temperature: -50°C...+105°C

### Dimensions [mm]

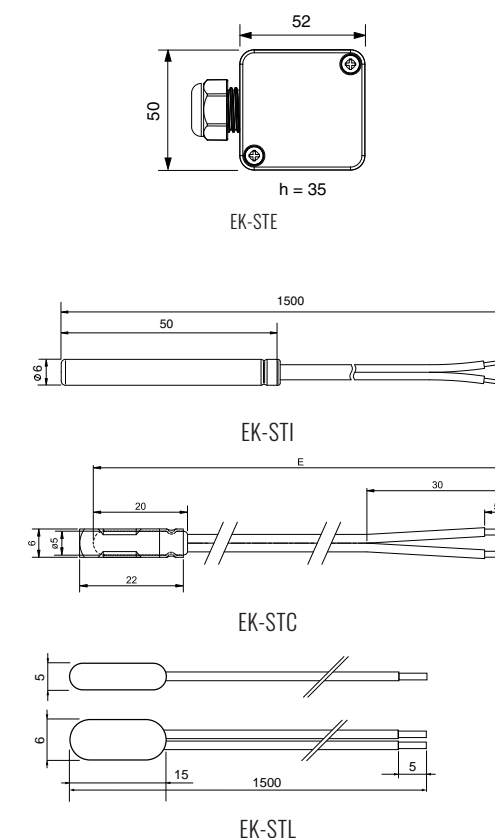

### Order information

Code	Version	Package
EK-STE-10K-3435	outdoor	1 pcs.
EK-STI-10K-3435	immersion	
EK-STC-10K-3435	contact	
EK-STL-10K-3435	air mass	



### Configuration and commissioning

The configuration is necessary for the Ekinex® KNX device connected to the temperature sensor.



### Documentation

For further information, please see **STEKSTX10K3435\_EN.pdf**  
technical sheet, available for download from [www.ekinex.com](http://www.ekinex.com)



EK-STE EK-STI EK-STC EK-STL





## Modbus / KNX interface for RDZ air handling units

THERMOREGULATION

### Description

The Ekinex® EK-B01-TP-RMA interface is a modular KNX S-mode device that allows bidirectional communication between the RDZ air handling units, equipped with control board with RS-485 Modbus communication port, and the KNX system (TP). Thanks to the interface, the functions performed by the air handling units can be controlled and monitored by KNX devices. The unit has an integrated KNX bus communication module and is realized for mounting on a 35 mm rail. Power is supplied via the KNX bus.

### Main features

- Housing in plastic material
- Mounting on 35 mm rail (according to EN 60715)
- Protection degree IP20 (installed device)
- Safety class II
- Weight 70 g
- 2 modular units (1 unit = 18 mm)
- Dimensions 36 x 94 x 71 mm (WxHxD)

### Technical data

#### Power supply

- 30 Vdc voltage by KNX bus
- Current consumption (from main bus line) < 13 mA

### Dimensions [mm]

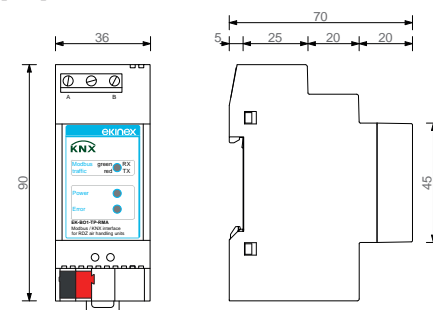

### Order information

Code	Package
EK-B01-TP-RMA	1 pcs.



### Configuration and commissioning

By means of ETS5 software or later versions  
Application program **APEKBO1TPRMA#.knxprod**  
(download from [www.ekinex.com](http://www.ekinex.com))



### Documentation

For more information, see the **STEKBO1TPRMA\_EN.pdf** technical sheet available for download from [www.ekinex.com](http://www.ekinex.com)



## Gateway

DIN-RAIL MOUNT MODULES

EK-BH1-TP-485 Gateway Modbus RS485-KNX	EK-BH1-TP-TCP Gateway Modbus TCP/IP-KNX	EK-BJ1-TP-IP Gateway BACnet IP-KNX	EK-BJ1-TP-MSTP Gateway BACnet MS/TP-KNX	EK-BK1-TP Gateway DMX-KNX	EK-BM1-TP-xx Gateway M-Bus-KNX	EK-BN1-TP Gateway PROFINET-KNX	EK-BG1-TP Gateway DALI-KNX
--	---	---	--	---------------------------------	--------------------------------------	--------------------------------------	----------------------------------



Auxiliary power supply	•	•	•	•	•	•	•
Electrically insulated RS485 serial communication port	•	-	-	•	•	-	-
1-way DIP switch to activate the line terminator (120 Ohm)	•	-	-	-	•	-	-
Modbus master RTU (Remote Terminal Unit) communication	•	•	-	-	-	-	-
BACnet slave communication	-	-	•	-	-	-	-
BACnet communication	-	-	-	-	-	-	-
PROFINET slave communication	-	-	-	-	-	•	-
BACnet records exchange	-	-	•	-	-	-	-
PROFINET records exchange	-	-	-	-	-	•	-
DMX master communication	-	-	-	•	-	-	-
250 kbaud communication speed	-	-	-	-	•	-	-
From 1200 to 115200 baud communication speed	•	-	-	•	-	-	-
from 3000 to 38400 baud communication speed	-	-	-	-	-	•	-
Ethernet (IEEE 802.3) communication port, RJ45 connector	-	•	•	-	-	-	•
M-Bus communication port	-	-	-	-	-	•	-
Device addressing from 1 to 250	-	-	-	-	-	•	-
Device addressing from 0 to 250	•	•	-	-	-	-	-
Device addressing from 0 to 512	-	-	-	-	•	-	-
Register exchange of Coil, Input, and Input Register Holding Register type	•	•	-	-	-	-	-
Reading and writing of single and multiple registers	•	•	-	-	-	-	-
1 byte register writing on a maximum of 512 DMX devices	-	-	-	-	•	-	-
Volatile support memory with "image Modbus" of 1440 byte	•	•	-	-	-	-	-
Volatile support memory with "image BACnet" of 1440 byte	-	-	•	•	-	-	-
Volatile support memory with "image M-Bus" of 1440 byte	-	-	-	-	-	•	-
Volatile support memory with "image PROFINET" of 1440 byte	-	-	-	-	-	-	•
KNX TP (twisted pair) 9600 baud communication port	•	•	•	•	•	•	•
Volatile support memory with "image KNX" of 1440 byte	•	•	•	•	•	•	•
Additional plug-in program	•	•	•	•	•	•	•
Mounting on standard 35 mm rail (EN 60715)	•	•	•	•	•	•	•
DALI communication protocol	-	-	-	-	-	-	•
Ballast addressing to 64 devices	-	-	-	-	-	-	•

## Gateway Modbus RS485 - KNX

GATEWAYS



### Description

The Ekinex® Modbus RS485 - KNX Gateway performs a protocol conversion between a serial RS485 Modbus RTU and a KNX TP network. The device works as Modbus master. The device integrates a KNX bus communication module and it is suitable for mounting on a 35 mm DIN rail; it requires an auxiliary power supply.

### Main features

- Plastic casing
- Connection to bus line with KNX terminal block
- Installation on 35 mm rail (according to EN 60715)
- 4 modular units (1 MU = 18 mm)
- IP20 protection degree (installed device)
- Weight 145 g

### Technical data

- Power supply: 8...24 Vac or 12...35 Vdc
- Absorption at 24 Vdc: 3,5 VA

### Communication

#### KNX side

- KNX TP (Twisted Pair) communication port electrically isolated from power supply
- 1440-byte volatile support "KNX image" memory buffer

#### Modbus RS485 side

- RS485 serial communication port, electrically isolated from power supply, 120 ohm termination resistance pluggable by a 1-way microswitch
- Modbus master RTU (Remote Terminal Unit) communication
- Selectable baud rate from 1200 to 115200 baud
- Device addressing from 0 to 250
- Coil, Input, Holding Register e Input Register data exchange
- Single and multiple register reading/writing
- 1440-byte volatile support "Modbus image" memory buffer

### Configuration

- Ethernet communication port (IEEE 802.3), RJ45 connector, minimum cable category: 5E

### Products included

The delivery includes the device and terminal blocks to connect to the KNX bus.

### Other information

Modbus® is an open source, standard communication protocol suitable for master / slave data exchange between smart devices in various applications, such as industrial production, infrastructure, transportation and energy management.

### Dimensions [mm]

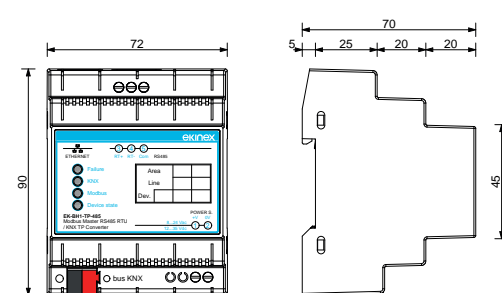

### Configuration and commissioning

By means of software tool **CGEKBH1TP485.exe** (download from [www.ekinex.com](http://www.ekinex.com))



### Documentation

For further information please refer to data sheet **STEBH1TP485\_EN.pdf**, download from [www.ekinex.com](http://www.ekinex.com)



### Order information

Code	Application	Package
EK-BH1-TP-485	protocol conversion KNX - Modbus RTU	1 pcs.

## Gateway Modbus TCP/IP - KNX

GATEWAYS



### Description

The Ekinex® Modbus TCP/IP - KNX Gateway performs a protocol conversion between a Modbus RTU over TCP / IP and a KNX TP network. The device works as Modbus master. The device integrates a KNX bus communication module and it is suitable for mounting on a 35 mm DIN rail; it requires an auxiliary power supply.

### Main features

- Plastic casing
- Connection to bus line with KNX terminal block
- Installation on 35 mm rail (according to EN 60715)
- 4 modular units (1 MU = 18 mm)
- IP20 protection degree (installed device)
- Weight 145 g

### Technical data

- Power supply: 8...24 Vac or 12...35 Vdc
- Absorption at 24 Vdc: 3,5 VA

### Communication

#### KNX side

- KNX TP (Twisted Pair) communication port electrically isolated from power supply
- 1440-byte volatile support "KNX image" memory buffer

#### Modbus TCP/IP side

- Ethernet communication port (IEEE 802.3), RJ45 connector, minimum cable category: 5E. Communication Modbus master RTU (Remote Terminal Unit)
- Device addressing from 0 to 250
- Coil, Input, Holding Register e Input Register data exchange
- Single and multiple register reading/writing
- 1440-byte volatile support "Modbus image" memory buffer

### Configuration

- Ethernet communication port (IEEE 802.3), RJ45 connector, minimum cable category: 5E.

### Products included

The delivery includes the device and terminal blocks to connect to the KNX bus.

### Other information

Modbus® is an open source, standard communication protocol suitable for master/ slave data exchange between smart devices in various applications, such as industrial production, infrastructure, transportation and energy management.

### Dimensions [mm]

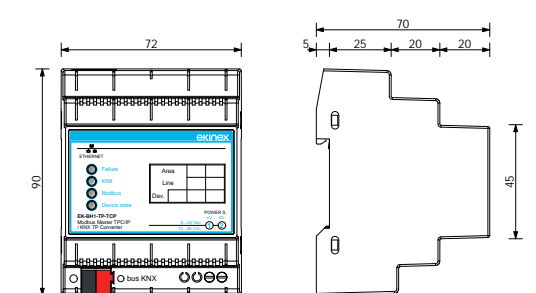

### Configuration and commissioning

By means of software tool **CGEKBH1TPTCP.exe** (download from [www.ekinex.com](http://www.ekinex.com))



### Documentation

For further information please refer to data sheet **STEBH1TPTCP\_EN.pdf**, download from [www.ekinex.com](http://www.ekinex.com)



### Order information

Code	Application	Package
EK-BH1-TP-TCP	protocol conversion KNX - Modbus RTU	1 pcs.



## Gateway BACnet - KNX

GATEWAYS

### Description

The Ekinex® BACnet - KNX Gateway performs a protocol conversion between a BACnet and a KNX TP network. Two versions are available: BACnet MS/TP (master-slave / token-passed) over serial RS485 network and BACnet IP over Ethernet. The device integrates a KNX bus communication module and it is suitable for mounting on a 35 mm DIN rail; it requires an auxiliary power supply.

### Main features

- Plastic casing
- Connection to bus line with KNX terminal block
- Installation on 35 mm rail (according to EN 60715)
- 4 modular units (1 MU = 18 mm)
- IP20 protection degree (installed device)
- Weight 145 g

### Technical data

- Power supply: 8...24 Vac or 12...35 Vdc
- Absorption at 24 Vdc: 3,5 VA

### Communication

#### KNX side

- KNX TP (Twisted Pair) communication port electrically isolated from power supply
- 1440-byte volatile support "KNX image" memory buffer

#### BACnet (MS/TP version) side

- RS485 serial communication port, electrically isolated from power supply, 120 ohm termination resistance pluggable by a 1-way microswitch
- BACnet communication
- Selectable baud rate from 1200 to 115200 baud
- BACnet objects exchange
- 1440-byte volatile support "BACnet image" memory buffer

#### BACnet side (IP version)

- Ethernet communication port (IEEE 802.3), RJ45 connector, minimum cable category: 5E. Communication BACnet slave
- BACnet objects exchange
- 1440-byte volatile support "BACnet image" memory buffer

#### Configuration

- Ethernet communication port (IEEE 802.3), RJ45 connector, minimum cable category: 5E.

#### Products included

The delivery includes the device and terminal blocks to connect to the KNX bus.

#### Other information

BACnet® is an ASHRAE (American Society of Heating, Refrigerating and Air-Conditioning Engineers) trademark.

#### Dimensions [mm]

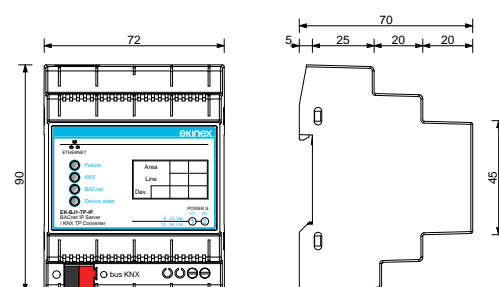

#### Configuration and commissioning

By means of software tool **CGEKB1TP.exe** (download from [www.ekinex.com](http://www.ekinex.com))



#### Order information

Code	Version	Application	Package
EK-BJ1-TP-IP	IP over Ethernet	protocol conversion KNX - BACnet	1 pcs.
EK-BJ1-TP-MSTP	MS / TP over RS485	protocol conversion KNX - BACnet	1 pcs.

#### Documentation

For further information please refer to data sheet **STEKBJ1TP\_EN.pdf**, download from [www.ekinex.com](http://www.ekinex.com)



MS/TP IP

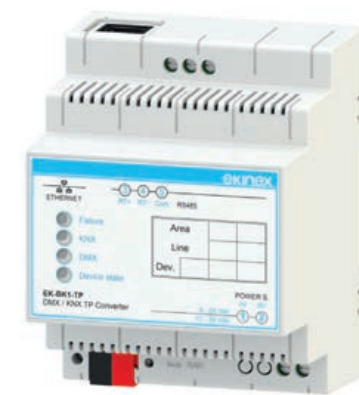

## Gateway DMX - KNX

GATEWAYS

### Description

The Ekinex® DMX - KNX Gateway performs a protocol conversion between a serial RS485 DMX and a KNX TP network. The device works as DMX master. The device integrates a KNX bus communication module and it is suitable for mounting on a 35 mm DIN rail; it requires an auxiliary power supply.

### Main features

- Plastic casing
- Connection to bus line with KNX terminal block
- Installation on 35 mm rail (according to EN 60715)
- 4 modular units (1 MU = 18 mm)
- IP20 protection degree (installed device)
- Weight 145 g

### Technical data

- Power supply: 8...24 Vac or 12...35 Vdc
- Absorption at 24 Vdc: 3,5 VA

### Communication

#### KNX side

- KNX TP (Twisted Pair) communication port electrically isolated from power supply
- 1440-byte volatile support "KNX image" memory buffer

#### DMX side

- RS485 serial communication port, electrically isolated from power supply, 120 ohm termination resistance pluggable by a 1-way microswitch
- DMX master communication
- Baud rate 250 kbaud
- Device addressing from 0 to 512
- 1-byte register writing on max 512 DMX devices

#### Configuration

- Ethernet communication port (IEEE 802.3), RJ45 connector, minimum cable category: 5E

#### Products included

The delivery includes the device and terminal blocks to connect to the KNX bus.

#### Other information

DMX512 is a standard for asynchronous serial transmission of digital data between controllers, devices and accessories for the light industry, approved by ANSI (American National Standards Institute) and supported by ESTA (Entertainment Services and Technology Association).

#### Dimensions [mm]

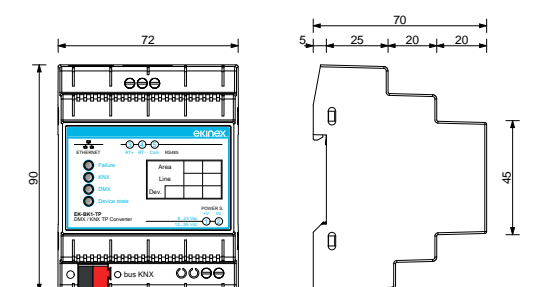

#### Configuration and commissioning

By means of software tool **CGEKBK1TP.exe** (download from [www.ekinex.com](http://www.ekinex.com))



#### Order information

Code	Application	Package
EK-BK1-TP	protocol conversion KNX - DMX512	1 pcs.

#### Documentation

For further information please refer to data sheet **STEKKB1TP\_EN.pdf**, download from [www.ekinex.com](http://www.ekinex.com)







## Gateway M-Bus - KNX

GATEWAYS

### Description

The Ekinex® M-Bus - KNX Gateway performs a protocol conversion between an M-Bus and a KNX TP network. The device acts as M-Bus master. Versions for networks with a maximum number of 20, 40, 80 and 160 connected M-Bus slave devices are available. The device integrates a KNX bus communication module and it is suitable for mounting on a 35 mm DIN rail; it requires an auxiliary power supply.

### Main features

- Plastic casing
- Connection to bus line with KNX terminal block
- Installation on 35 mm rail (according to EN 60715)
- 4 modular units (1 MU = 18 mm)
- IP20 protection degree (installed device)
- Weight 145 g

### Technical data

- Power supply: from M-Bus network
- Absorption at 24 Vdc: 3,5 VA (without load); 4, 5, 8 or 14 VA (resp. with 20, 40, 80 or 160 M-Bus devices)

### Communication

#### KNX side

- KNX TP (Twisted Pair) communication port electrically isolated from power supply
- Baud rate 9600 baud
- 1440-byte volatile support "KNX image" memory buffer

#### M-Bus side

- M-Bus communication port (wired version, two-pole cable)
- Selectable baud rate from 300 to 9600 baud
- Device addressing from 1 to 250
- Variable reading through M-Bus slave device mapping
- 1440-byte volatile support "M-Bus image" memory buffer

### Configuration

- Ethernet communication port (IEEE 802.3), RJ45 connector, minimum cable category: 5E

### Products included

The delivery includes the device and terminal blocks to connect to the KNX bus.

### Other information

M-Bus (Meter-Bus) is a standard protocol for remote reading of data acquired from thermal energy, electricity, gas and water meters. M-Bus is fully compliant with EN 13757: Communication Systems for remote meter reading, parts 2 (Physical and connection layer) and 3 (Application layer).

### Dimensions [mm]

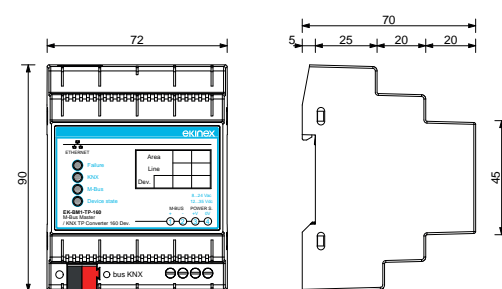

 **Configuration and commissioning**  
By means of software tool **CGEKBMTIP.exe** (download from [www.ekinex.com](http://www.ekinex.com))



 **Documentation**  
For further information please refer to data sheet **STEKBM1TP\_EN.pdf**, download from [www.ekinex.com](http://www.ekinex.com)



## Gateway PROFINET - KNX

GATEWAYS

### Description

The Ekinex® PROFINET - KNX Gateway performs a protocol conversion between a PROFINET and a KNX TP network. The device acts as slave of PROFINET communication. The device integrates a KNX bus communication module and it is suitable for mounting on a 35 mm DIN rail; it requires an auxiliary power supply.

### Main features

- Plastic casing
- Connection to bus line with KNX terminal block
- Installation on 35 mm rail (according to EN 60715)
- 4 modular units (1 MU = 18 mm)
- IP20 protection degree (installed device)
- Weight 145 g

### Technical data

- Power supply: 8...24 Vac or 12...35 Vdc
- Absorption at 24 Vdc: 3,5 VA

### Communication

#### KNX side

- KNX TP (Twisted Pair) communication port electrically isolated from power supply
- 1440-byte volatile support "KNX image" memory buffer

#### PROFINET side

- Ethernet communication port (IEEE 802.3), RJ45 connector, minimum cable category: 5E. Communication PROFINET slave
- PROFINET data exchange
- 1440-byte volatile support "PROFINET image" memory buffer

### Configuration

- Ethernet communication port (IEEE 802.3), RJ45 connector, minimum cable category: 5E.

### Products included

The delivery includes the device and terminal blocks to connect to the KNX bus.

### Other information

PROFINET (Process Field Net) is an open source, Ethernet based (IEEE 802.xx) standard communication protocol, suitable for data exchange between field devices in industrial and process automation applications. The standard is supported by PROFIBUS & PROFINET International (PI) association.

### Dimensions [mm]

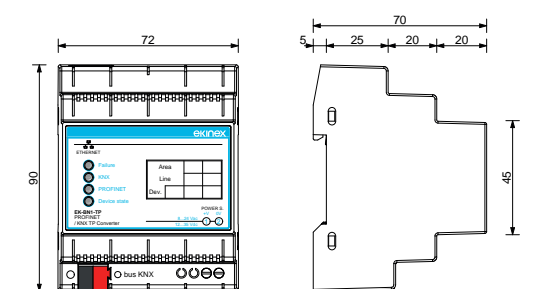

 **Configuration and commissioning**  
By means of software tool **CGEKBMTIP.exe** (download from [www.ekinex.com](http://www.ekinex.com))



 **Documentation**  
For further information please refer to data sheet **STEKBN1TP\_EN.pdf**, download from [www.ekinex.com](http://www.ekinex.com)





## Gateway DALI - KNX

GATEWAYS

### Description

The Ekinex® DALI - KNX Gateway allows the control of the devices present in a DALI network from a KNX TP network. The device has an integrated KNX bus communication module and integrates the power supply stage for the DALI bus.

### Main features

- Connection to the KNX bus line with standard KNX terminal block
- Plastic casing
- Installation on 35 mm rail (according to EN 60715)
- 4 modular units (1 MU = 18 mm)
- IP20 protection degree (installed device)

### DALI functions

- Control of up to 64 DALI devices in up to 16 groups
- Up to 16 light Scenes
- Broadcast function
- Individual, group or central addressing
- Suitable for operation in emergency lighting systems
- Readout of DALI device status via KNX (e.g. brightness or device error)

### Configuration

- Application program for ETS v.5 for the configuration of the KNX functions of the device
- PC application program for the configuration of the device and of DALI appliances

### Connections

- KNX port with standard connector
- Screw terminals (doubled) for the DALI bus
- Ethernet port (IEEE 802.3), RJ45 connector, category 5E cable (or higher)

### Technical data

- Device power supply: 230 Vac
- Power supply output for the DALI bus: 12 VDC 250mA

### Products included

The delivery includes the device and terminal blocks to connect to the KNX bus.

### Other information

DALI® (Digital Addressable Lighting Interface) is a worldwide standard protocol for lighting control interfacing systems, whose data exchange protocol is compliant with IEC 62386. DALI is a trademark of ZVEI (Zentralverband Elektrotechnik- und Elektronikindustrie e.V.).

### Dimensions [mm]

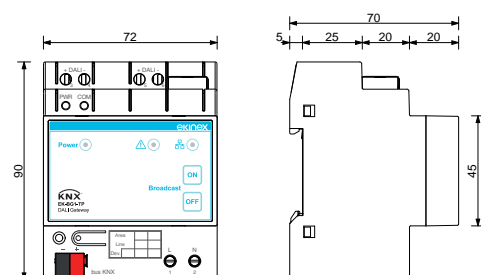

## Voice control interface - KNX

GATEWAY

### Description

Device with interface function between a KNX network (TP, twisted pair) and home speakers equipped with Amazon Alexa or Google Assistant. The interface, connected to Ekinex cloud services, is suitable for the control by voice commands of light, climate and motorization of a modern KNX standard building. The product is designed for installation on DIN profile rail and occupies 2 modules. The 12-24 Vdc power supply is external (power supply not included in the supply). The product with hardware based on embedded operating system, has a KNX TP node (twisted pair) and can therefore be connected directly to the bus network of KNX devices. The external connectivity is realized through the Ethernet port that connects the device directly to the home router.

The integrated web server provides access to the configuration environment and provides the following functions:

- Interface network settings
- Registration and subscription to ekinex cloud services
- Automatic import of the ETS project and merging with previous imports
- Configuration of voice control accessories (max 150 accessories): lighting (on/off, dimmed and RGB), motorizations (open/close stop and position) and climate
- Configuration of action sequences on the KNX bus, which can be called up as scenarios by voice assistants
- Configuration of the IFTTT (If This Than That) cloud platform for the creation of association rules between events on the KNX bus and compatible services (e.g. sending e-mail)
- On the Amazon Alexa and Google Assistant apps, the Ekinex skill and action are available respectively for the complete configuration of the service.

### Main features

- 12-24 Vdc power supply (absorption 240 mA at 12 Vdc) by means of a special plug-in terminal supplied. Power supply not included
- KNX TP bus (twisted pair) via red-black terminal provided
- 1 Ethernet port via cat. 5 or higher cable and standard RJ45 connector
- 2 frontal LEDs: POWER LED for signalling the presence of power supply; SERVICE LED for signalling particular operations in progress.
- 1 RESET button housed under the front cover on the back of the vertical card
- 1 RS485 port: not used
- 1 USB 2.0 port: not used

### Dimensions [mm]

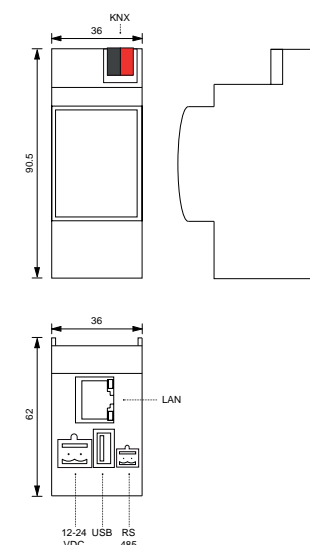

### Order information

Code	Application	Package
EK-BG1-TP	protocol conversion KNX - DALI	1 pcs.



### Configuration and commissioning

By means of the PC software **CGEKBG1TP.exe** and the ETS v.5 application program **APEKBG1TP##.knxprod** (download both from [www.ekinex.com](http://www.ekinex.com))



### Documentation

For further information please refer to data sheet **STEKBG1TP\_EN.pdf**, download from [www.ekinex.com](http://www.ekinex.com)



### Order information

Code	Application	Package
EK-BW1-TP	Voice control	1 pcs.



### Configuration and commissioning

Through internet browser configurable both locally and remotely via cloud access.



### Documentation

For further information please refer to data sheet **STEKBW1TP\_EN.pdf**, download from [www.ekinex.com](http://www.ekinex.com)





# CoolMasterNet with integrated KNX module

GATEWAY

## Metering

DIN-RAIL MOUNT MODULES

### Description

CoolMasterNet Ekinex® is a plug and play interface for bidirectional data exchange between the KNX home automation system and the bus communication system dedicated to air conditioning through VRF / VRF and splits. CoolMasterNet allows the KNX system to individually monitor and control all the units connected to the bus system dedicated to air conditioning. The LCD touch-screen also allows the direct control of every unit. Among the available\* controls there are:

- on/off
- mode (Cool, Heat, Auto, Fan)
- fan speed
- temperature setpoint
- room temperature feedback
- error code

The dedicated CoolRemote App allows the remote login via web through smartphone, tablet or PC to verify the status of the system and possible error codes (where available) and perform basic controls such as on/off (individual or collective), setup of the temperature setpoint, selection of the operating mode and fan speed. The device is equipped with communication lines for the following manufacturers: Mitsubishi Electric, Daikin, Toshiba, Panasonic, Sanyo, Hitachi, Mitsubishi Heavy Industries, LG, Samsung, and Gree. The device integrates a KNX bus communication module and is realized for wall-mounting. The device is powered by a SELV 12-24 Vdc voltage.

### Main features

- Plastic material
- Colour LCD touch-screen display
- Green (on/off connection) and orange (Tx/Rx indication) LED
- Connection to bus line with KNX terminal block
- RS232 (ASCII), RS485 (Modbus RTU), Ethernet (ASCII, Modbus IP), mini USB (maintenance) ports
- Wall-mounting
- Weight 270 g

### KNX module

- Pre-installed in factory
- Activated through assignment of L3 communication line
- 128 default group addresses (expandable to 1.024)

### Dimensions [mm]

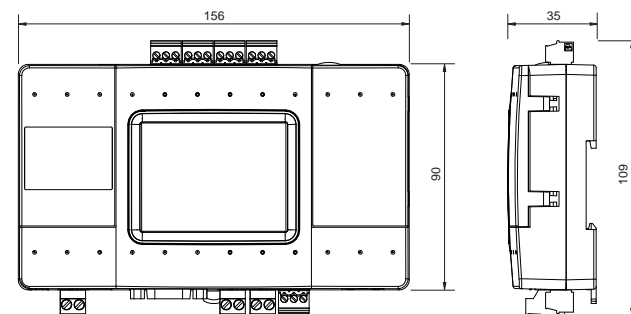

### Configuration and commissioning

By means of application program **Quickinstall** (download from [www.ekinex.com](http://www.ekinex.com))



### Documentation

For further information please refer to data sheet **STEKQBQ1TP\_EN.pdf**, download from [www.ekinex.com](http://www.ekinex.com)



	EK-ME1-MDB Network analyzer (basic)	EK-MEK-xx Kit network analyzer (enhanced) and Rogowski coils	EK-ME1-06T 6 A three-phase MID energy meter	EK-ME1-80M 80 A single-phase MID energy meter	EK-ME1-80T 80 A three-phase MID energy meter	EK-MC1-MD Modbus communication module	EK-MC1-TP KNX communication module
--	--	---	--	--	---	--	---------------------------------------

Three-phase energy meter	•	•	•	-	•	-	-
Single-phase energy meter	-	-	-	•	-	-	-
Direct connection	-	-	•	•	•	-	-
Rogowski coil	•	•	-	-	-	-	-
Fully bi-directional four quadrants measurements for all energies and powers	•	•	•	•	•	-	-
Main electrical parameters measured and displayed for a cost-effective consumption analysis	•	•	-	-	-	-	-
For 3 / 4 wire networks with balanced or unbalanced load	•	•	-	-	•	-	-
Class B according to EN 50470-3	-	-	•	•	•	-	-
Tariff Input	-	-	•	•	•	-	-
2 SO outputs for energy pulse emission	-	-	•	•	•	-	-
1 configurable digital output	•	•	-	-	-	-	-
Possibility to record MIN / AVG / MAX values for all powers	•	•	-	-	-	-	-
LCD-Display	•	•	•	•	•	-	-
Optical port for communication	-	-	•	•	•	-	-
Sealable cover to prevent tampering	•	•	•	•	•	-	-
MID Certificate	-	-	•	•	•	-	-
Modbus RTU (8N1) and ASCII (7E2) protocol	•	•	-	-	-	•	-
- RS485 port	-	-	-	-	-	•	-
- Communication speed: 300 ÷ 115200 bps	-	-	-	-	-	•	-
- Termination resistor integrated in the module	-	-	-	-	-	•	-
- Optical port for communication	-	-	-	-	-	•	-
- Communication speed: 38400 bps	-	-	•	•	•	-	-
KNX protocol	-	-	-	-	-	-	•
- Communication speed: 9600 bps	-	-	-	-	-	-	•
Plug-in software	•	•	-	-	-	-	-
Mounting on standard 35 mm rail (EN 60715)	•	•	•	•	•	•	•





## Network analyzer

METERING

### Description

The Ekinex® network analyzer EK-ME1-MDB is a three-phase multifunctional instrument for measurement and recording of electrical parameters with separate inductive and capacitive counters. Delivery includes a digital output (DO) and a RS485 serial port for communication over Modbus RTU/ASCII protocol. Possibility to update the firmware version remotely is given. The device is suitable for mounting on a 35 mm DIN rail; it requires an auxiliary power supply.

### Functions

- Fully bidirectional four quadrants measurements for all energies and powers
- Main electrical parameters measured and displayed for a cost effective consumption analysis
- Version for 1 or 5A CT
- 1 MB for data recording
- Possibility to record average values for active & reactive powers
- Modbus RTU / ASCII communication by RS485 port
- Possibility to manage the instrument in remote mode by WintoolNETME1 software

### Main features

- Plastic casing
- Backlighted LCD-Display, 43 x 29 mm 3 rows, 4 digits + symbols
- Keyboard: 3 front buttons + 1 protected button
- Screw terminal blocks connection
- Installation on 35 mm DIN rail (according to EN 60715)
- 4 modular units (1 MU = 18 mm)
- Protection degree IP20 (installed device)
- Weight 310 g

### Technical data

#### Power supply

- Voltage range: 85...265 Vac
- Max consumption: 1,6 VA - 1 W

#### Voltage inputs

- Voltage range: 3x10 / 17 ... 3x285 / 495 Vac, Cat III 300 V

#### Current inputs

- Maximum value: 6 A

#### Digital output (DO)

- Type: Passive optoisolated
- Maximum values (according to IEC / EN 62053-31): 27 Vdc - 27 mA

### Dimensions [mm]

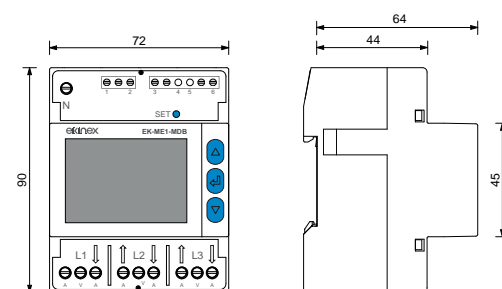

## Kit with network analyzer and Rogowski coils

METERING

### Description

The kit Ekinex® EK-MEK includes a EK-ME1-MDE network analyzer (enhanced version) and three sensors for measurement and recording of Rogowski current. Sensors are available with the following lengths: 300, 450 and 700 mm.

### Functions (network analyzer)

- Fully bidirectional four quadrants measurements for all energies and powers
- Main electrical parameters measured and displayed for a cost effective consumption analysis
- Version for 1 or 5A CT
- 8 MB for data recording
- Possibility to record MIN / AVG / MAX for instantaneous parameters
- Possibility to record all energy counters
- Modbus RTU / ASCII communication by RS485 port
- Possibility to manage the instrument in remote mode by WintoolNETME1 software

### Main features

#### Network analyzer

- Plastic casing
- Backlighted LCD-Display, 43 x 29 mm 3 rows, 4 digits + symbols
- Keyboard: 3 front buttons + 1 protected button
- Screw terminal blocks connection
- Installation on 35 mm DIN rail (according to EN 60715)
- 4 modular units (1 MU = 18 mm)
- Protection degree IP20 (installed device)
- Weight 260 g

### Rogowski coils

#### Transducer

- Coil length: 30, 45 or 70 cm
- Wire diameter: 8,3 ± 0,2 mm
- Closing: bayonet
- Weight: from 150 to 500 g
- Material: thermoplastic UL94-V0

### Electrical features

- Output level (RMS): 100 mV / 1 kA @50Hz (standard)
- Transducer resistance: from 70 to 900 Ω
- Position error: less than ±1% of reading (with wire diameter = 15 mm)
- Frequency: around 40 Hz at 20 kHz
- Operating voltage: 1000 VRMS CAT III, 600 VRMS CAT IV
- Pollution degree 2
- Test voltage: 7400 VRMS / 1 min

### Connection wires

- Type: 2 x 0,15 mm shielded
- Length: 300 cm

### Products included

Delivery includes a network analyzer and 3 Rogowski coils.

### Dimensions [mm]

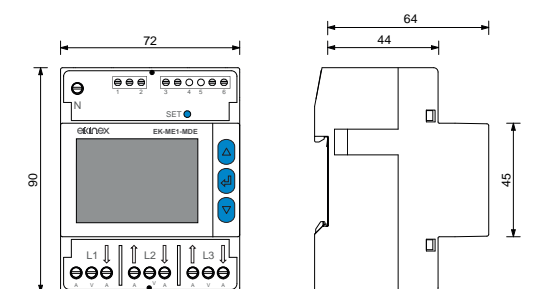

### Order information

Code	Device	Package
EK-ME1-MDB	Network analyzer in enhanced version	1

### Remote management

By means of the software tool **WintoolNETME1** (download from [www.ekinex.com](http://www.ekinex.com))



### Documentation

For more information, see the **STEKMEIMDBE\_EN.pdf**, technical sheet for download from [www.ekinex.com](http://www.ekinex.com)



### Order information

Code (kit)	Device	Sensors
EK-MEK-30	Network analyzer (enhanced version)	3 Rogowski coils 30 cm length
EK-MEK-45		3 Rogowski coils 45 cm length
EK-MEK-70		3 Rogowski coils 70 cm length

### Remote management

By means of the software tool **WintoolNETME1** (download from [www.ekinex.com](http://www.ekinex.com))



### Documentation

For more information, see the **STEKMEIMDBE\_EN.pdf** and **STEKROG\_EN.pdf** technical sheets for download from [www.ekinex.com](http://www.ekinex.com)





## 80 A MID single phase energy meter

METERING

### Description

The 80 A single-phase compact energy meter Ekinex® EK-ME1-80M performs the measurement of energy and main electrical parameters in industrial and civilian application. The backlit LCD allows to display energies and instantaneous powers. Delivery includes a tariff input and two SO outputs for energy pulse emission. The device is also equipped with an optical port for communication with other systems as well as Ekinex® Modbus RS485 (EK-MC1-MD) and KNX (EK-MC1-TP) communication modules. It has MID certification for billing, metrological LED on the front panel and lateral anti-effraction sealing. The device is suitable for mounting on a 35 mm DIN rail.

### Functions

- Fully bidirectional four quadrants measurements for all energies and powers
- Direct connection up to 80 A

### Main features

- Plastic casing
- Backlit LCD-Display with 7 main digits
- Screw terminal blocks connection
- Installation on 35 mm DIN rail (according to EN 60715)
- Protection degree IP20 (installed device)
- 2 modular units (1 MU = 18 mm)
- Weight 200 g

### Technical data

#### Power supply

- Power supplied from the voltage circuit
- Nominal measurement voltage  $\pm 20\%$
- Max consumption: 7,5 VA - 0,5 W

#### Voltage

- 230...240 V 50 / 60 Hz (nominal values)

### Current

- Starting current  $I_{st}$ : 20 mA
- Minimum current  $I_{min}$ : 250 mA
- Transition current  $I_{tr}$ : 500 mA
- Reference current  $I_{ref}$  (Ib): 5 A
- Maximum current  $I_{max}$ : 80 A

### Accuracy

- Active energy class B according to EN 50470-3
- Reactive energy class 2 according to IEC / EN 62053

### SO outputs

- 2 passive optoisolated
- Maximum values: 250 Vac-dc - 100 mA
- Pulse length: 50  $\pm$  2 ms ON time

### Tariff input

- Active optoisolated
- Voltage range for tariff 2: 80 ... 276 Vac-dc

### Metrological LED

- Meter constant: 10000 imp / kWh

### Products included

Delivery includes a sealable cover for terminal blocks.

### Dimensions [mm]

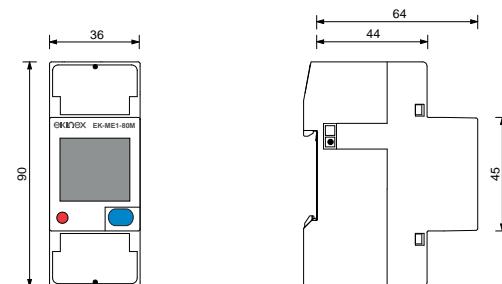

### Monitoring

By means of the software tool **Ekinex® Modbus Master** (download from [www.ekinex.com](http://www.ekinex.com))



### Documentation

For more information, see the **STEKME180M\_EN.pdf**, technical sheet for download from [www.ekinex.com](http://www.ekinex.com)



## 6 A MID three phase energy meter

METERING

### Description

The 6 A three-phase compact energy meter Ekinex® EK-ME1-06T performs the measurement of energy and main electrical parameters in industrial and civilian application. The backlit LCD allows to display energies and instantaneous powers. Delivery includes a tariff input and two SO outputs for energy pulse emission. The device is also equipped with an optical port for communication with other systems as well as Ekinex® Modbus RS485 (EK-MC1-MD) and KNX (EK-MC1-TP) communication modules. It has MID certification for billing, metrological LED on the front panel and lateral anti-effraction sealing. The device is suitable for mounting on a 35 mm DIN rail.

### Functions

- Fully bidirectional four quadrants measurements for all energies and powers
- Version for 1 or 5A CT (programmable CT value)
- For 3 / 4 wire networks with balanced or unbalanced load

### Main features

- Plastic casing
- Backlit LCD-Display with 8 main digits
- Screw terminal blocks connection
- Installation on 35 mm DIN rail (according to EN 60715)
- Protection degree IP20 (installed device)
- 4 modular units (1 MU = 18 mm)
- Weight 320 g

### Technical data

#### Power supply

- Power supplied from the voltage circuit
- Nominal measurement voltage  $\pm 20\%$
- Max consumption: 7,5 VA - 0,5 W
- CT burden (for each phase): 0,04 VA

#### Voltage and frequency

- 3x230 / 400 3x240 / 415 V 50 / 60 Hz (nominal values)

### Current

- Starting current  $I_{st}$ : 2 mA
- Minimum current  $I_{min}$ : 10 mA
- Transition current  $I_{tr}$ : 50 mA
- Reference current  $I_{ref}$  (Ib): 1 A
- Maximum current  $I_{max}$ : 6 A

### Accuracy

- Active energy class B according to EN 50470-3
- Reactive energy class 2 according to IEC / EN 62053

### SO outputs

- 2 passive optoisolated
- Maximum values: 250 Vac-dc - 100 mA
- Pulse length: 50  $\pm$  2 ms

### Tariff input

- Active optoisolated
- Voltage range for tariff 2: 80 ... 276 Vac-dc

### Metrological LED

- Meter constant: 10000 imp / kWh

### Products included

Delivery includes a sealable cover for terminal blocks.

### Dimensions [mm]

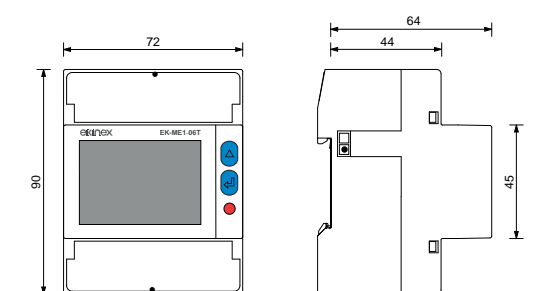

### Monitoring

By means of the software tool **Ekinex® Modbus Master** (download from [www.ekinex.com](http://www.ekinex.com))



### Documentation

For more information, see the **STEKME106T\_EN.pdf**, technical sheet for download from [www.ekinex.com](http://www.ekinex.com)





## 80 A MID three phase energy meter

METERING

### Description

The 80 A three-phase compact energy meter Ekinex® EK-ME1-80T performs the measurement of energy and main electrical parameters in industrial and civilian application. The backlit LCD allows to display energies and instantaneous powers. Delivery includes a tariff input and two SO outputs for energy pulse emission. The device is also equipped with an optical port for communication with other systems as well as Ekinex® Modbus RS485 (EK-MC1-MD) and KNX (EK-MC1-TP) communication modules. It has MID certification for billing, metrological LED on the front panel and lateral anti-effraction sealing. The device is suitable for mounting on a 35 mm DIN rail.

### Functions

- Fully bidirectional four quadrants measurements for all energies and powers
- Direct connection up to 80 A
- For 3 / 4 wire networks with balanced or unbalanced load

### Main features

- Plastic casing
- Backlit LCD-Display with 8 main digits
- Tariff input
- 2 SO outputs for energy pulse emission
- Optical port for communication with external modules
- Screw terminal blocks connection
- Installation on 35 mm DIN rail (according to EN 60715)
- Protection degree IP20 (installed device)
- 4 modular units (1 MU = 18 mm)
- Weight 435 g

### Technical data

#### Power supply

- Power supplied from the voltage circuit
- Nominal measurement voltage ± 20%
- Max consumption: 7,5 VA - 0,5 W

#### Voltage and frequency

- 3x230 / 400 3x240 / 415 V 50 / 60 Hz (nominal values)

#### Order information

Code	Package
EK-ME1-80T	1 pcs.

### Current

- Starting current  $I_{st}$ : 20 mA
- Minimum current  $I_{min}$ : 250 mA
- Transition current  $I_{tr}$ : 500 mA
- Reference current  $I_{ref}$  (Ib): 5 A
- Maximum current  $I_{max}$ : 80 A

### Accuracy

- Active energy class B according to EN 50470-3
- Reactive energy class 2 according to IEC / EN 62053

### SO outputs

- 2 passive optoisolated
- Maximum values: 250 Vac-dc - 100 mA
- Pulse length: 50 ± 2 ms ON time

### Tariff input

- Active optoisolated
- Voltage range for tariff 2: 80 ... 276 Vac-dc

### Metrological LED

- Meter constant: 10000 imp / kWh

### Products included

Delivery includes a sealable cover for terminal blocks.

### Dimensions [mm]

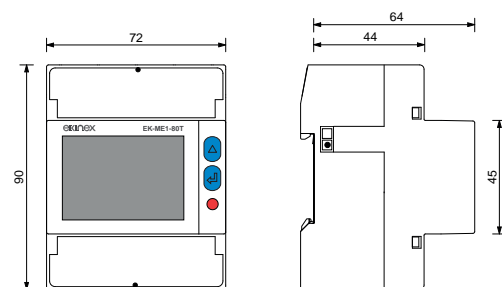

#### Monitoring

By means of the software tool **Ekinex® Modbus Master** (download from [www.ekinex.com](http://www.ekinex.com))

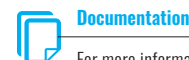

#### Documentation

For more information, see the **STEKME180T\_EN.pdf**, technical sheet for download from [www.ekinex.com](http://www.ekinex.com)



## Modbus communication module

METERING

### Description

The Ekinex® RS485 Modbus communication module EK-MC1-MD collects and transmits, through Modbus RTU or ASCII protocol, measurement data of Ekinex® single and three phase energy meters. Data transmission between meter and communication module is performed through the integrated optical port. Change of RS485 parameters is made directly on the combined meter or by sending the proper Modbus protocol commands to the module. The device is suitable for mounting on a 35 mm DIN rail.

### Main features

- Plastic casing
- Set default pushbutton to restore all parameters to the factory settings
- Frontal LED for Power (POWER) and Communication (ACT / ERR) status
- Bus line connection through KNX terminal block
- Installation on 35 mm DIN rail (according to EN 60715)
- 1 modular unit (1 MU = 18 mm)
- Protection degree IP20 (installed device)
- Weight 65 g

### Technical data

#### Power supply

- Nominal voltage: 230 Vac ± 20% / 50 Hz
- Max repetitive voltage: 300 Vac
- Max non repetitive voltage peak: 320 Vac (20 ms)
- Consumption: max 5 VA

### Communication

#### Modbus side

- Protocol: Modbus RTU (8N1) and ASCII (7E2)
- Port: RS485
- Communication speed: 300...115200 bps
- Termination resistor integrated in the module

#### Meter side

- Type: serial, optical port
- Communication speed: 38400 bps

### Products included

Delivery includes a terminal block for connecting the bus line.

### Dimensions [mm]

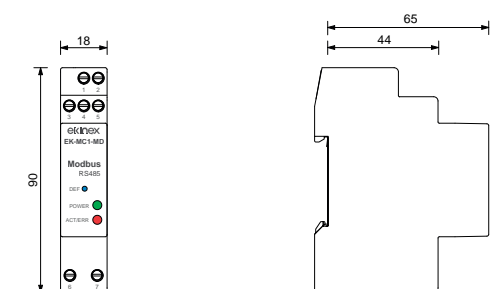

#### Monitoring

By means of the software tool **Ekinex® Modbus Master** (download from [www.ekinex.com](http://www.ekinex.com))



#### Documentation

For more information, see the **STEKMC1MD\_EN.pdf**, technical sheet for download from [www.ekinex.com](http://www.ekinex.com)







## KNX communication module

METERING

### Description

The Ekinex® KNX communication module EK-MC1-TP collects and transmits, through KNX bus line, measurement data of Ekinex® single and three phase energy meters. Data transmission between meter and communication module is performed through the integrated optical port. A LED on the front displays informations about powering status. The device integrates a KNX bus communication module and is realized for mounting on a standard 35 mm DIN-rail.

### Main features

- Plastic casing
- Programming LED and pushbutton on the front
- Connection to bus line with KNX terminal block
- Installation on 35 mm DIN rail (according to EN 60715)
- 1 modular unit (1 MU = 18 mm)
- Protection degree IP20 (installed device)
- Weight 40 g

### Technical data

- Voltage range: 24 Vdc from KNX bus
- Max consumption: < 10 mA

### Communication

#### KNX side

- Protocol: KNX (TP)

#### Meter side

- Type: serial, optical port
- Communication speed: 38400 bps

### Products included

Delivery includes a terminal block for connecting the bus line.

### Dimensions [mm]

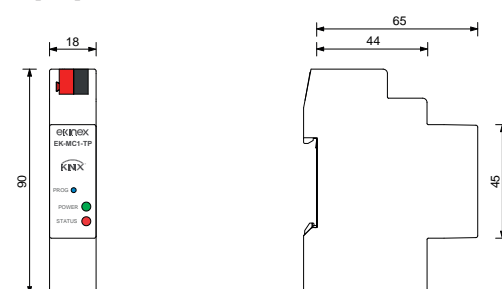

### Order information

Code	Application	Package
EK-MC1-TP	Transmission over KNX of data measured by Ekinex® meters	1 pcs.



### Configuration and commissioning

By means of ETS5 software or later versions  
Application program **APEKMC1TP##.knxprod**  
(## = version, download from [www.ekinex.com](http://www.ekinex.com))



### Documentation

For more information, see the **STEKMC1TP\_EN.pdf**, technical sheet for download from [www.ekinex.com](http://www.ekinex.com)



### Description

Terminal block for the connection of KNX bus lines or SELV auxiliary power supply. It allows the connection of max. 4 pairs of wires. To be used also as distribution terminal in wall boxes.

### Colour coding

- EK-MNR-TP: red = + (positive), black = - (negative)
- EK-MGB-TP: yellow = + (positive), white = - (negative)

### Main features

- 4 plug-in seats for each polarity
- Fast spring connection
- Suitable for solid wire diameter 0,6÷0,8 mm
- Mechanical coding for terminal block housing on devices
- Wire strip length (advised) 5-6 mm

### Order information

Code	Colour coding	Use	Package
EK-MNR-TP	red/black	bus connection	50
EK-MGB-TP	yellow/white	SELV connection	50



### Description

The bus cable LSHF (Low Smoke Halogen Free) is a twisted pair cable for the connection of KNX bus devices and the derivation of KNX bus lines. It is available with a single pair of wires with a diameter of 0.8 mm. Screen in aluminium foil. For use in dry interior.

### Main features

- Cable for KNX based applications (TP)
- Single pair of wires Ø 0,8 mm
- Black/red wires for KNX bus line connection
- Yellow/white wires for auxiliary SELV or spare power supply

### Order information

Code	Type	Use	Package [m]
EK-112-TP	1 x 2 x 0,8	bus connection	100
EK-114-TP	2 x 2 x 0,8	bus connection and spare pair	100

## Terminal blocks

ACCESSORIES

### Technical data

- Nominal voltage 100 V
- Nominal current 6 A

### Products included

Package of 50 pieces.

### Note

A terminal block for the connection of KNX bus line (EK-MNR-TP) is supplied with every Ekinex® device. A terminal block for the connection of SELV auxiliary power supply is supplied along with EK-AG1-TP power supply and Touch&See unit.

### Dimensions [mm]

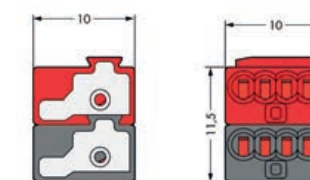

EK-MNR-TP



EK-MGB-TP

## Bus cable

ACCESSORIES

### Technical data

- Nominal voltage: 50 V
- Test voltage: 4 kV

### Products included

100 m bundle covered with cellophane.



EK-112-TP



EK-114-TP





## Ekinex Delégo: the system

### SUPERVISION

Delégo is a system for the supervision and control of a KNX home automation system. Developed with web-oriented technologies, it has a uniform interface with high graphical impact on every platform, both desktop (PC) and mobile (Apple iOS and Android devices), with both local and remote connection. The system consists of a compact server (based on Linux operating system) to be installed in an electrical box: the device connects directly to the KNX bus via twisted pair; the connection to the home router is made via the Ethernet port on your local network (LAN).

The user can interact with the system either by means of mobile devices, or with one or more fixed stations, by means of Delégo panel a touch-panel with elegant and minimal design, for wall installation, connected via Ethernet port on its local network (LAN). The Delégo supervision system is characterized by a simple and at the same time extremely complete configuration, thanks to the direct import of the ETS project file. The functional definition of the various imported domotic objects and the correspondence with a rich and customizable set of controls (widgets) for the user, is also very straightforward.

The renewed interface is simple and intuitive and allows the user to interact with the home automation system of his smarthome through the use of different devices, with absolute uniformity of use. The app allows you to remotely control lights, climate, automatisms, audio/video equipment, shutters and more with a simple touch, from a single device and from anywhere in the building reached by the Wi-Fi network, or remotely via web connection.





## Renewed graphic interface

### SUPERVISION

The redesigned visual interface can be accessed either via an app for smartphone and tablet (supported operating systems: Apple iOS and Android) or from a desktop PC workstation. All the devices can be interfaced with the server previously configured so that all the functions of the automation system can be controlled and viewed. The app, accessible from mobile devices (smartphones and tablets) or fixed devices (Delégo panel), is structured for the logical vision of the building, by areas or services. The supervision with desktop PC also allows the visualization with synoptic: the plan of the space can be associated, following the physical location, with the set of available services.

#### VISUALIZATION BY AREAS

The app will display a list of configured areas, each identified by an image inserted in the web configurator during the commissioning phase:

In each area set through the web configurator (for example: living room, bedroom, kitchen) the user can choose whether to turn on or off the lights, or to change the settings of the room thermostat and other settings for each of the available features; Simple navigation between the different areas configured with a touch of the display.

#### VISUALIZATION BY SERVICES

The visualization of each area can be filtered through a toolbar that allows you to easily select the individual function available:

##### Lighting

##### Air conditioning

##### Shading and motorized automations

##### Scenarios

The app can be extended with the functions provided by the compatible video surveillance, intrusion detection and audio/video systems integrated in the Delégo server.





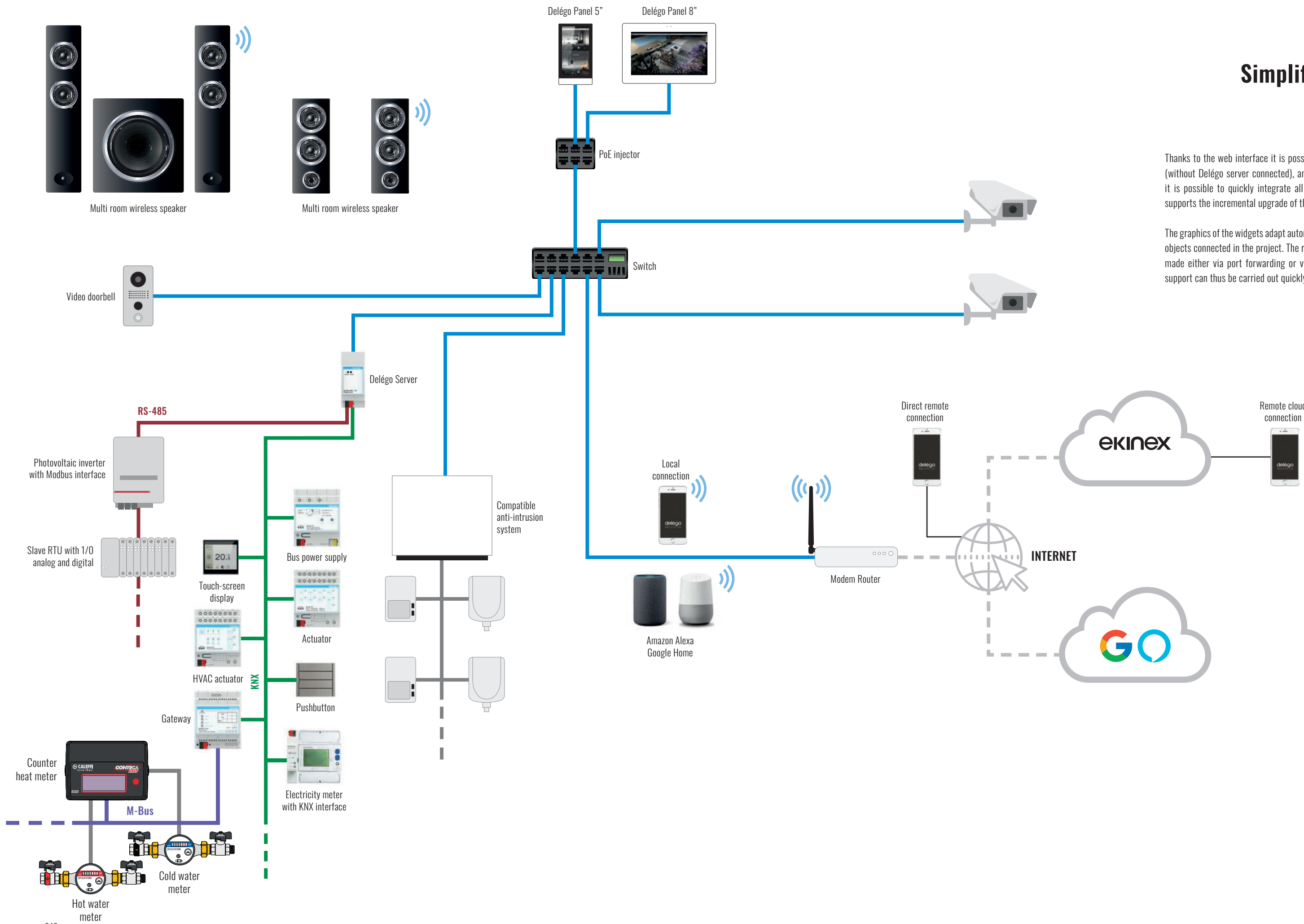

## Simplified configuration and maintenance

SUPERVISION

Thanks to the web interface it is possible to program the system online and offline (without Delégo server connected), and thanks to the ETS' project file import tool, it is possible to quickly integrate all the group addresses used. The system also supports the incremental upgrade of the installation via subsequent imports.

The graphics of the widgets adapt automatically according to the KNX communication objects connected in the project. The remote connection of the Delégo server can be made either via port forwarding or via native cloud connection. Maintenance and support can thus be carried out quickly and with reduced running costs.

# Complete versatility

SUPERVISION

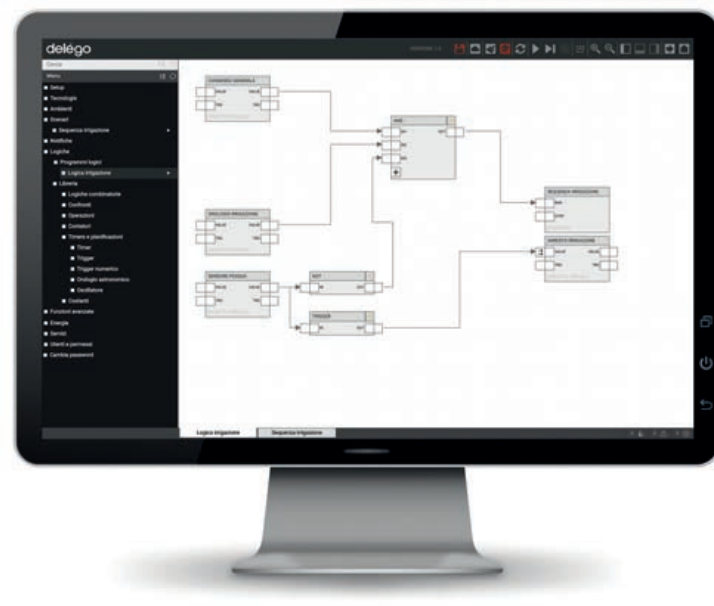

### Multiplatform

Delégo server can be managed by PC, MAC, Touch-PC, smartphone and tablet through a common Internet browser or with a free dedicated app (available for Apple devices and Android).

### Customizable

the graphics and automatic functions of Delégo server can be easily modified according to your needs, accessing the web pages with your PC of administration.

### Quick to configure

Delégo server proposes a set of ready-to-use functions typically used in the home automation supervisors and allows you to quickly import the structure of your own ETS building (KNX installation).

### Multi-protocol

Delégo server can be connected directly to both the KNX bus in the twisted version pair, both to Modbus on RS485 network and via TCP/IP protocol via Ethernet port. Thanks to the multi-protocol management it is possible to connect intrusion detection systems, thermoregulation, multimedia systems and video surveillance.

### Easy to install

Thanks to the size of only 2 modules on DIN rail, Delégo server can be easily installed directly into the electrical cabinet. The communication ports to the LAN, KNX bus and other technological subsystems do not require any additional external interfaces.

### Reliable

The Delégo server is based on a Linux operating system that guarantees reliability and stability. of the platform for continuous use, as well as providing a high degree of safety on the net.

### Also offline

It is possible to build the supervision project even without being connected to the webserver, working in "offline" mode directly on your PC or MAC.

### 100% Made in Italy

Hardware and software are designed, manufactured, assembled and tested entirely in Italy, to guarantee the highest quality of the product and after-sales service competent and helpful.

# Main features

SUPERVISION

## SOFTWARE FEATURES

<b>Standard technologies</b>	KNX RS-485 / TCP / UDP configurable Modbus RTU/TCP	
<b>User Interface</b>	Web / HTMLS (All operating systems) Dedicated app (iOS   Android)	
<b>Number of users</b>	Unlimited without additional licenses	
<b>Synchronized connections</b>	Up to 20 (scalable on request)	
<b>Technological systems</b>	Lighting Heating / air conditioning Motorized doors and windows Irrigation Thermal power plant   thermoregulation Technical alarms Consumption and energy management Load control Weather control IP Cameras / IP Video Intercoms Intrusion detection Audio/Video broadcasting	
<b>Compatibility of operating systems</b>	Microsoft Windows Apple Mac OSX Linux	Apple iOS Android

## VISUALIZATION

<b>Layout</b>	Graphics scalable by resolution Automatic recognition of mobile devices Full support for touch and multi-touch devices
<b>Navigation</b>	Personalized graphic pages Multi-level environment navigation Navigation by functions Summary popups for the most complex functions Always accessible and customizable menu
<b>Customization</b>	Scenarios, Calendar schedules
<b>Notifications and messages</b>	Notifications on screen, Email, Push notifications
<b>Cloud Services</b>	Remote Accessibility, Weather Services, IFTTT

## SETUP AND CONFIGURATION

<b>Configuration mode</b>	Online Offline via free downloadable tool
<b>Environment of configuration</b>	Integrated search engine Navigation tree for access to all functions Drag & drop Multi-tab for multiple simultaneous configuration functions
<b>Setup and maintenance</b>	Network Date and time Backup / stay configuration via browser Language selection Graphic Themes Selection and Layout Customization Software update via browser
<b>Environments / graphic pages</b>	Grid layout and graphic map Customizable background images Custom Object Sorting/Placement
<b>Advanced Functions</b>	Scenarios with timings Logics Comparison of values and levels Mathematical operations Custom functions via scripting
<b>Planning and calendar</b>	Unlimited number of daily profiles for each object Weekly and annual profiles Configuration accessible by end user
<b>Energy Management</b>	Support for KNX network analyzers, ModBus Integrated load control function Graphical visualization of consumption and production Real-time load absorption display Automatic comparisons and consumption indicators
<b>Voice Control</b>	Amazon Alexa - Google Assistant
<b>Users and security</b>	Unlimited number of users Unlimited access Secure SSL access via internet



## Delégo server

SUPERVISION

### Description

Web supervisor for home and building automation systems based on the KNX system. It allows to manage the functions present in the building through any type of device (PC/MAC, touch-PC, smartphone, tablet) as long as it is equipped with a web browser, both locally and remotely through internet. Customizable graphics suitable for any context and application, optimized for visualization on different fixed and mobile platforms. Simplified and fast configuration of KNX functions. Possibility to realize scenarios, time sequences, logics, conditions, operations mathematics, temporal planning through simple graphical tools and intuitive: reporting events and alarms on screen or via email. Configuration online or offline via free downloadable PDF tool: does not require programming or HTML skills for supervision customization. Interfacing with other communication technologies and protocols by enabling additional modules.

### Main features

- **Dimensions:** 90.5 x 62 x 36 mm 2 DIN modules
- **Power supply:** 12 - 24 VDC Plug-in terminal provided
- **Absorption:** 240mA at 24V
- **Connections:** LAN (RJ45)  
KNX (standard red-black connector)  
RS485 (terminal supplied)  
USB
- **LED:** Power  
Service / Reset
- **Degree of protection:** IP 20 (according to EN 60529)
- **Insulation class:** II (according to EN 60335-1)
- **Operating temperature:** +0°C ... +40°C
- **Storage temperature:** 10°C ... +70°C

### Dimensions [mm]

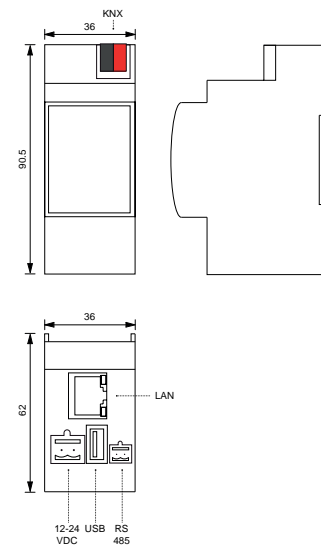

### Documentation

For further information please refer to data sheet (download from [www.ekinex.com](http://www.ekinex.com))



### Order information - Licenses

Code	Composition	License version	KNX Addresses	Scenarios	Logics/Thresholds	Environments	Loads	Cameras	Package
EK-DEL-SRV-BAS-TP	Delégo server	BASIC	400	100	100	Unlimited	Unlimited	Unlimited	1 pcs.
EK-DEL-UPGR-BA	Upgrade License	ADVANCED	1200	100	100	Unlimited	Unlimited	Unlimited	
EK-DEL-UPGR-BP		PREMIUM	2500	100	100	Unlimited	Unlimited	Unlimited	
EK-DEL-VOIP	Voucher	Voucher to enable the module IP video intercom							
EK-DEL-INTRDET	Voucher	Voucher to enable the module Intrusion detection							
EK-DEL-MODBUS	Voucher	Voucher to enable the module Modbus (> 30 registers)							

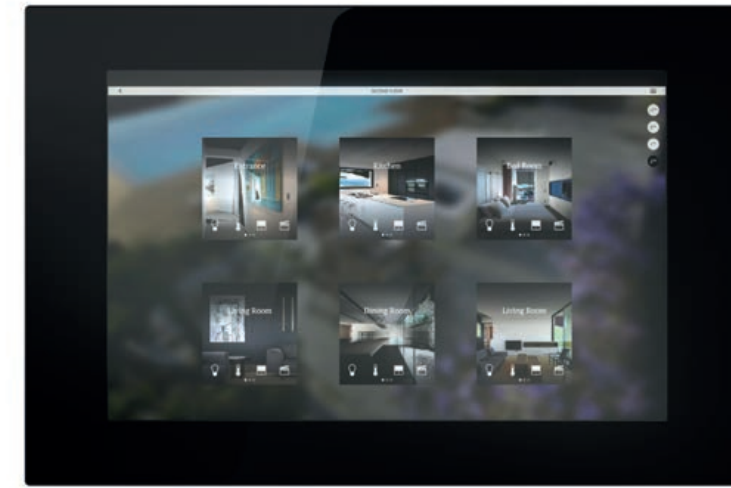

## Delégo panel

SUPERVISION

### Description

The touch-panels of the Delégo series are a must-have instrument for the management of the modern connected building. Through these you can control all the automation functions of the premises: lights, roller shutters, burglar alarm, climate control, building management, etc. energy saving and multimedia system. Delégo touch-panels are available in two cuts, with 5" and 8" capacitive display, with black frame. The elegance of the minimalist design, the exceptional graphic of the HD display and the outstanding performances, make Delégo panel ideal for home, office, businesses, and any other area of installation.

### Main features

- **Overall dimensions (mm):** 81 x 132 x 14 (5") - 224 x 149 x 16 (8")
- **Wall-mounting box (5"):** 2M wall-mounting box (Ex: Bticino mod. 502E)  
Round box diameter 60 (Ex: Gewiss mod. 24232)  
3M wall-mounting box (e.g. BTicino mod. 503E) (\*)
- **Wall-mounting box (8"):** Bticino mod. 16204
- **Orientation:** Portrait 5" or Landscape 8"
- **Power supply:** Power Over Ethernet (POE)
- **Typology:** LCD HD IPS 5" - LCD HD IPS 8"
- **Resolution:** 1280 x 720
- **Colours:** 16.7 million colours (true colour)
- **Brightness:** 400 nits
- **Touch screen:** Capacitive with multi-touch & gestures support
- **Speakers:** High definition with built-in 2W amplifier
- **Microphone:** Integrated high resolution with echo canceling
- **Gyroscope:** Automatic orientation detection
- **Proximity:** Integrated proximity detection
- **Brightness:** Integrated ambient light sensor
- **Connectivity:** LAN 100baseT
- **Certifications:** CE / FCC class B / FCC part15 / ROHS / WEEE
- **Operating System:** Android 6

### Dimensions [mm]

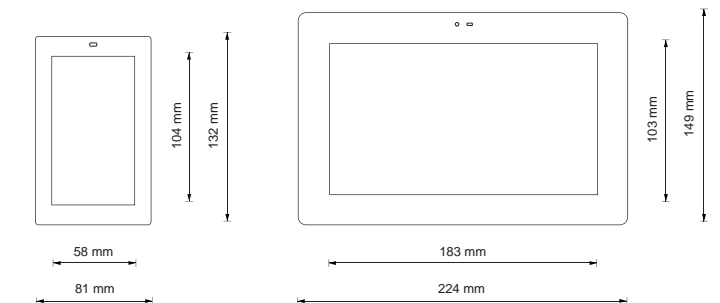

Possibility of customization through aluminium frame (5" version only)

### Order information

Code	Composition	Package
EK-DEL-5PAN	Delégo panel 5" - black panel	1 pcs.
EK-DEL-8PAN	Delégo panel 8" - black panel	1 pcs.
EK-DEL-5FR-...	Aluminium frame for 5" Delégo panel	1 pcs.

(\*) Box 503 must be mounted with the same orientation as the device.



### Documentation

For further information please refer to data sheet (download from [www.ekinex.com](http://www.ekinex.com))







# TOOLS

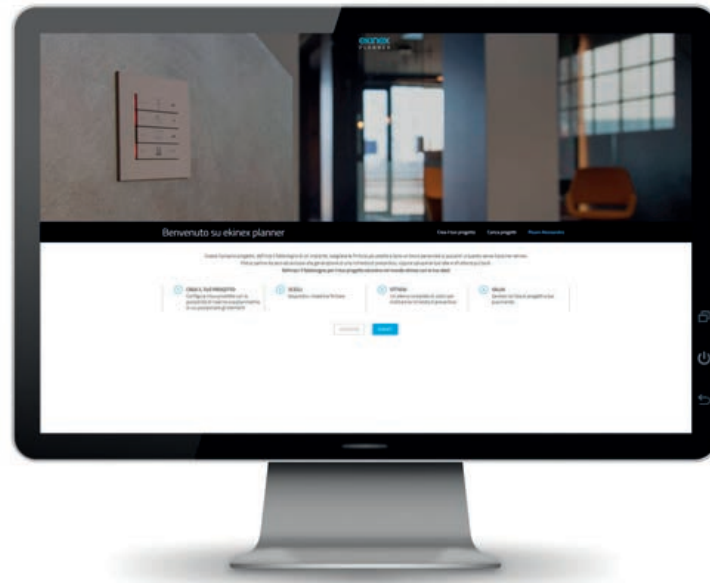

#### Description

PLANNER is a configuration software made available on its website from Ekinex®. This tool, from the easy to use and driven, allows the end user and the designer to identify products that are perfectly suited to the needs of the project. With PLANNER you can also choose and test different combinations of buttons and civil series finishes to get closer as possible to the desired result. PLANNER allows you to fill out a simple list of devices to be used or they can be placed in a preview of a user-uploaded file, in order to recreate the actual conditions of the future installation. Finally, the software allows you to create a database of your projects with the ability to retrieve and modify projects at all times. When you finish using PLANNER allows you the chance to ask Ekinex® the best trade offer to the list of materials in your project

#### Use in 4 steps

##### 1) ADD A PROJECT

From the Ekinex® site, reach PLANNER by following this link: [planner.ekinex.com/en/](http://planner.ekinex.com/en/). At this point you can decide whether or not to insert a map (jpeg, gif, png, pdf image format); in any case you will be asked to give a name to your project, so that you can identify it later.

##### 2) SELECT DEVICES, MODELS AND FINISHING

PLANNER guides you on the page where you can find a list of products and create a list of devices to be installed in the system. All the wall-mount devices and DIN-Rail mount modules can be placed on the image of the plan if previously inserted.

##### 3) GET THE LIST

PLANNER gives you the ability to export and manage the list of chosen devices, to be able to control the features chosen.

##### 4) SAVE THE PROJECT

By clicking on "save changes", you will save the positions and changes made. You can also print the project and export the list of products in pdf format.

## Planner

TOOLS

#### Offer request

Planner is a great business tool. You can request this offer and conditions for devices of your project directly in the "PROJECT CONFIGURATION" by clicking on "request a quotation". The network of Ekinex® will contact you and will answer quickly and with the best offer for your project.

For further information contact: [sales@ekinex.com](mailto:sales@ekinex.com)

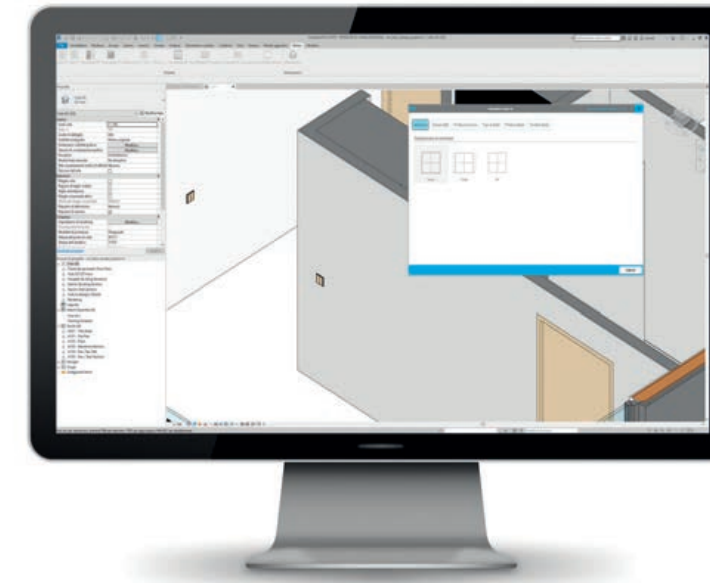

#### Description

BIM stands for Building Information Modeling and indicates a methodology aimed at optimizing and managing the design and construction of a building.

The BIM is therefore used mainly in the construction sector to promote a working method that involves the generation of a building model that can also manage the data of the entire life cycle through multi-dimensional virtual models generated digitally by means of specific software.

A BIM can contain any information about the building and its parts. The most commonly collected information is geometry, technical and mechanical data, electrical data, material specifications, financial, energy and environmental assessments.

#### What are the benefits of bim in home automation and construction?

The role of BIM in the construction industry is to support collaboration between the different actors involved (designers, builders, architects, clients) and integrate the design and simulation processes into a single model that can manage all phases of the life cycle of the building.

The main benefit of adopting the BIM methodology is the 3D representation during the design phase, which speeds up processes, reduces delivery times and allows errors and inaccuracies to be detected first. The greater efficiency in sharing information and a more precise control over all the processes involved, also make it possible to contain costs and schedule in advance maintenance operations.

The fields of BIM related to technology allow the management of complex projects such as home automation and the willingness of the customer to control the building. During the design phase it is already possible to simulate the integration of the different systems and the control of the possible scenarios in a 3D environment, giving all the professionals involved the opportunity to work together without data or process conflicts.

## Bim

TOOLS

#### Software

The BIM library is available in Autodesk Revit® format, by installing our **Ekinex BIM Content Creator software**, a real advanced configurator of the product range that will be enriched with future updates and expansions.

For further information:

[ekinex.com/en/bim/library-wall-mount.html](http://ekinex.com/en/bim/library-wall-mount.html)



ekinex

SALES KIT

Pocket Box	258
Color Ring	258
Color Box Pro	259
Style Box	260
Style Case	260
Tech Case	261





## Pocket Box

TOOLS

### Description

Pocketbox is a small and versatile tool that allows you to present Ekinex products in their natural size. Inside the box there are 19 1:1 scale cardboard models complete with description and QR code. Pocketbox is a small and versatile tool that allows you to present Ekinex® products in their natural size.

For further information: [sales@ekinex.com](mailto:sales@ekinex.com)

### Order information

Code	Package	Weight
EK-POC-BOX-EN	1 pcs.	0.109 Kg



## Color Box Pro

TOOLS

### Description

Color Box Pro is a finishing folder that contains a working KNX button equipped with 12 different materials, colours and button types. It is available in two versions: a folder is fully dedicated to the Fenix NTM® material, the other contains 6 plastic and 6 metal samples.

For further information: [sales@ekinex.com](mailto:sales@ekinex.com)

### Order information

Code	Finishing	Package	Weight
EK-CBP-NTM	Fenix NTM®	1 pcs.	1.332 Kg
EK-CBP-PLA-MET	Plastic and Metal	1 pcs.	1.332 Kg



## Color Ring

TOOLS

### Description

Color Ring is a ring equipped with rectangular keys made of plastic, metal and Fenix NTM® in real size that allows you to evaluate the chromatic combination between the button and the wall.

For further information: [sales@ekinex.com](mailto:sales@ekinex.com)

### Order information

Code	Finishing	Package	Weight
EK-CC-MET	Metal	1 pcs.	0.152 Kg
EK-CC-FEN	Fenix NTM®	1 pcs.	0.117 Kg
EK-CC-PLA	Plastic	1 pcs.	0.032 Kg



## Style Box

TOOLS

### Description

Style Box is an presentation box that contains one pushbutton to 4 channels of the 20venti, FF or 71 series in plastic material, complete with buttons and programmable KNX communication interface. It includes inside it more buttons and plates in different colours to assess the different colours and aesthetic solutions available. The pushbutton can be wall mounted and programmed to test its many functions.

For further information: [sales@ekinex.com](mailto:sales@ekinex.com)

### Order information

Code	Version	Package	Weight
EK-SB4-FF-FORM	style box FF series - Form	1 pcs.	0.500 Kg
EK-SB4-71-DEEP	style box 71 series - Deep	1 pcs.	
EK-SB4-71-SURFACE	style box 71 series - Surface	1 pcs.	
EK-SB4-20VENTI	style box 20venti series	1 pcs.	
EK-SB4-5PAN	style box Delégo panel 5"	1 pcs.	1.500 Kg



## Tech Case

TOOLS

### Description

Tech Case is an ideal solution to support KNX training (basic, advanced, hvac) and product presentations. Tech Case is made of a shock-resistant housing and is equipped with an integrated trolley system that makes it suitable for business travels. Tech Case is delivered with connected Ekinex devices and preinstalled application programmes.

For further information: [sales@ekinex.com](mailto:sales@ekinex.com)

### Order information

Code	Version	Package	Weight
EK-TCB-TP	basic	1 pcs.	11.000 Kg
EK-TCA-TP	advanced	1 pcs.	12.000 Kg



## Style Case

TOOLS

### Description

Style Case was thought to display the Ekinex® wall-mounting devices, appreciate the feel of materials and colours, test the effect on different wall backgrounds. It has four drawers for the different product lines (one of them is equipped with functioning devices) containing demo-versions of pushbutton and thermostats. Style Case also includes an array of pushbutton faceplates as a colour sampler; the front lid hosts a pouch for catalogues or note sheets. The suede leather belt provides for a convenient carrying handle.

For further information: [sales@ekinex.com](mailto:sales@ekinex.com)

### Order information

Code	Package	Weight
EK-SC3-01	1 pcs.	9,300 Kg





## Projecting, configuration and commissioning

### TECHNICAL SECTION

The Ekinex® home and buildings automation system was developed in accordance with the KNX open standard; therefore, the planning and the commissioning of a system as well as the configuration of its devices can be carried out easily by means of a PC and the ETS® software. The software allows to program Ekinex® devices, as well as thousands of other interoperable devices produced by companies which are members of KNX Association. All is needed to use Ekinex® devices in a system project, is the download from the [www.ekinex.com](http://www.ekinex.com) website of either the application programs general file, the Ekinex® product database containing software for all devices, or the single, specific-application program as necessary. After importing product data into the internal ETS® database, one may start laying out the home automation project.

The first activity required consists of assigning a name to the project, along with general descriptive information, which will permit to re-use the same project without problems, even after a long time. The next step is to define the building's structure and the topology required by the home automation project. The devices are looked up in the database, copied into the structure and assigned a unique id, corresponding to their physical address. At this point, each device may be configured independently, by setting a series of parameters, which vary according to the function to be performed. For example, independent function can be attributed to each different channel of a single push-button command, e.g. switching on or off an electrical appliance, a dimmer for a light source or the opening/closing control for a roll-up shutter. The next step is to define the interaction between multiple devices; unlike traditional installations, where this is achieved by physically laying cables, in a home automation system this action is performed by means of virtual connections generated by the ETS® program.

It is then possible to upload the application program to each device, thereby including all the settings required to perform the expected function within the system. ETS® also has utility functions for diagnoses and error search; for instance, it is possible to verify physical addresses and to check the status of each single devices on the connected bus. Lastly, the program can produce the necessary project documentation for the end user, so that it may be further expanded and adapted in the future. The constant attention of KNX towards the world of professionals developed into a wide offer of training courses. Courses for experts have been offered for years in numerous countries and KNX constantly monitors the activity of all certified training centres, where it is possible to become KNX Partners. The professional role of a KNX Partner is to guarantee a high level of system expertise in order to achieve the best results. Among KNX Partners are designers, installers and system integrators, who offer expert advice to plan, install, run and maintain a KNX-standard control system for homes and buildings.



In order to become KNX Partner, one must withstand a 40-hours theory and practise exam at a KNX-certified Training Centre. A complete list of KNX Partner is available on the website of KNX Association ([www.knx.org](http://www.knx.org)).



ETS® (Engineering Tool Software) is manufacturer-independent software, produced and marketed by KNX Association ([www.knx.org](http://www.knx.org))



# KNX technology

## TECHNICAL SECTION

KNX systems realize decentralized building automation; therefore, neither a central unit nor a supervising PC for control are required. Each device is fitted with an electronic part, which allows bus communication with all other devices on the bus, processes the received information or transmits the stored working parameters and the logics required for the completion of its task.

### Communication

Communication between KNX devices occurs in digital form, by means of serial transmissions of organized information, called "telegrams". A telegram includes the main information to be transmitted – e.g. a switch on or switch off command, a numerical value corresponding to a physical size detected by a sensor, etc. – and a series of accessory information required to guarantee an efficient, error-free communication. Any telegram, which is not duly received, can be repeated up to three times by the transmitting device. In order to avoid collisions between telegrams being sent out at the same time along the same bus from different devices, the CSMA/CA (Carrier Sense Multiple Access / Collision Avoidance) protocol is used. The information transmission speed occurs at 9600 bit/s, which makes it possible to avoid bus line resistor terminations.

### Transmission medium

The family of Ekinex® TP bus devices uses twisted-pair signal cables to transmit data; the correct communication is guaranteed by employing bus cables with 1 or 2 conductor pairs made in accordance with KNX Association's TP1 specifications.

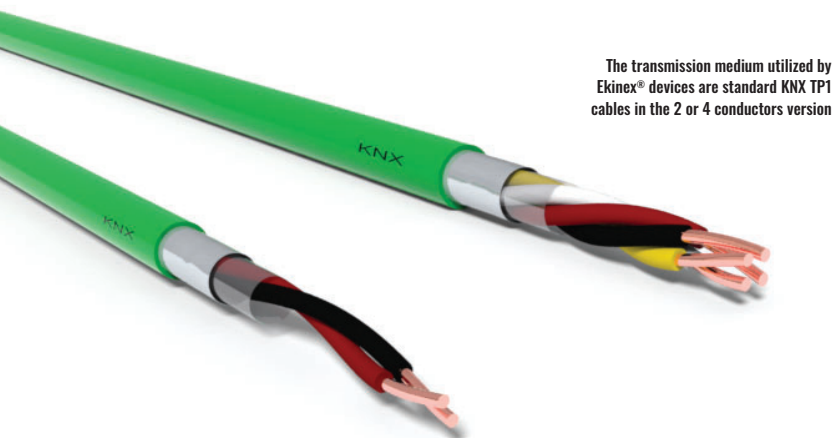

### Connecting the devices

Ekinex® devices are connected to the signal bus cable by means of the KNX bus termination block. The termination block and the cable form part of a convenient, fast-connection system aimed at eliminating errors: the cable has rigid connectors and the termination block is fitted with holding springs (instead of screws); besides, the termination block is formed by two elements having the same colour-coding (black/red) of the conductors to be connected. Each stripped bus conductor will be simply inserted in place, where it will stay firm thanks to the provided holding spring. Each polarity has 4 connection areas and the termination block may be extracted from its seat: Thanks to these two characteristics, the removal of any device from the bus cabling does not determine the interruption of communications with the remaining devices. The termination block is also used for branching cable segments on the same bus.



### Installation

KNX bus cables can be laid underneath the 230 Vac power cables along the same duct, provided they are kept isolated. Should the insulating sheath be removed, a distance of at least 4 mm between cable types must be guaranteed.

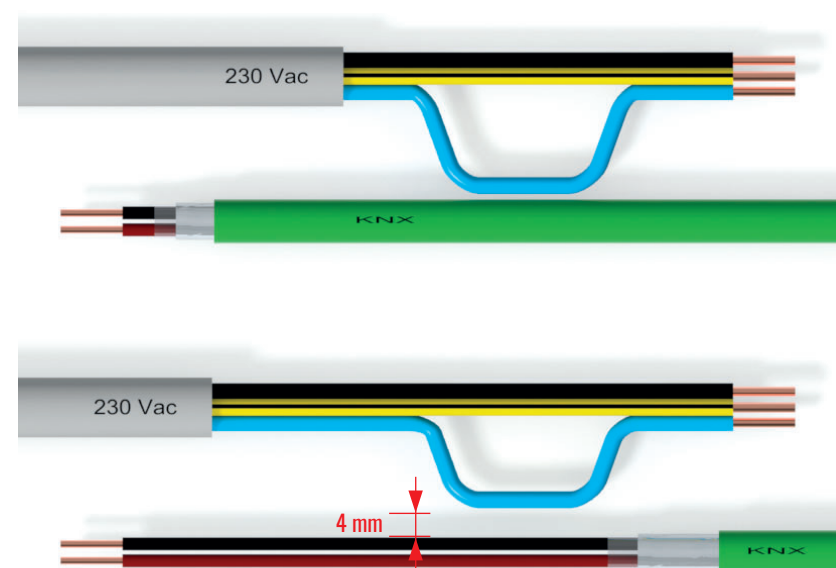

### Topology

The smallest KNX system may include a single bus line along which up to 64 devices can be connected. The line must be equipped with the special bus power supply, which provides the necessary SELV voltage for the system to work. The effective number of bus devices that can be connected to the line is determined at project level and may vary depending on the voltage supplied by the bus power supply and on the electrical absorption of each device on the bus. Since each Ekinex® device can process multiple functions, a single-bus line can suffice to control an apartment, a detached house or even a larger building with a limited number of bus functions.

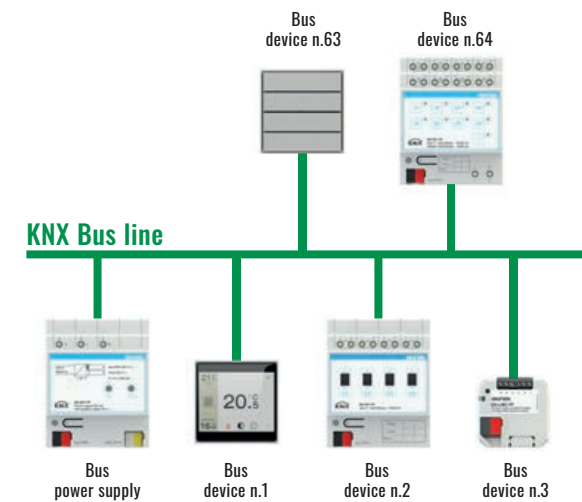

Next to a simple single-line configuration, a bus line can be subdivided into more segments, thus obtaining a star-shaped or a tree-shaped topology, or any combinations of the two.

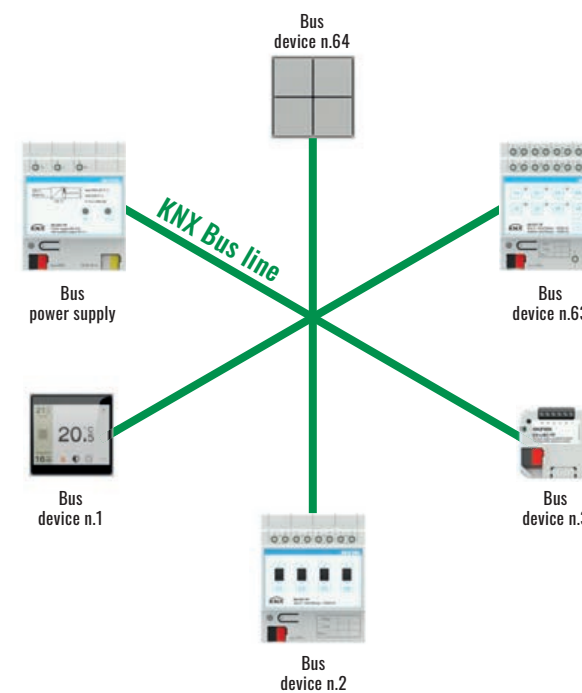

Adding line couplers, allows the system to expand to accommodate for larger buildings and/or higher numbers of required bus functions. Connecting more lines between them by means of couplers and a backbone line constitutes an area. An area is formed by a backbone line, up to 15 secondary lines and by all the devices connected along them. A unique number between 1 and 15 characterizes each secondary line. With little less than 1000 connectible KNX devices, an area permits the handling of a medium/large size system.

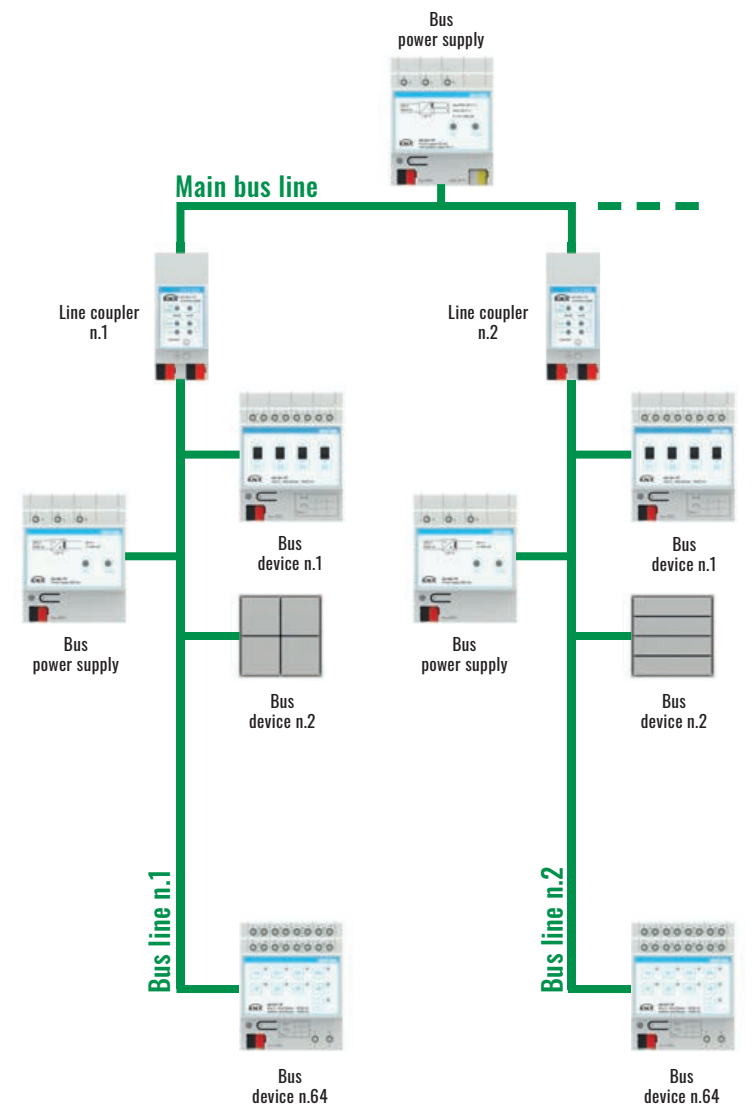

# KNX technology

TECHNICAL SECTION

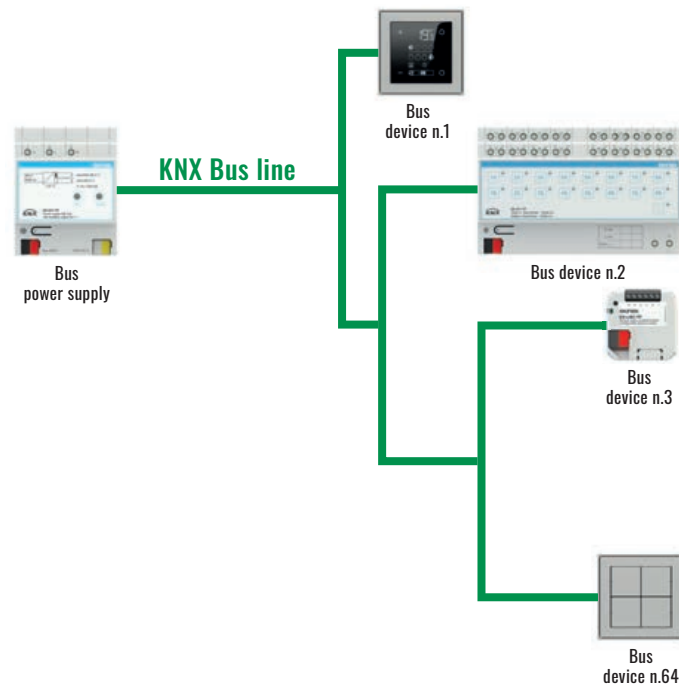

It is necessary to respect KNX topology prescriptions while designing the system, in order to guarantee communication within the system:

- the maximum allowed line length is 1000 m, including all branches;
- up to 64 bus devices can be connected to one line;
- the maximum distance between 2 devices is 700 meters;
- no bus device may be more than 350 meters apart from a bus power supply;
- in case of high numbers of bus devices (> 30) along limited sections lengths (10m), a second bus power supply can be installed, provided it sits at least 200 meters away from the first.

Should the demand increase, a KNX system can be further extended by connecting one another up to 15 areas. The main lines of each single area are connected to a backbone line by means of area couplers. Areas and main lines are numbered 1 to 15, while the backbone line bears number 0. The most extended KNX system permits to connect tens of thousands of devices, thus satisfying the necessities of very large buildings.

## Device addressing

The bus is a shared communication medium and each connected device must be exclusively distinguished from all others. The ETS® program takes care of that by assigning a physical address to each device; the address is represented in the form "area.line.device". Thanks to that, the topology of the entire system is mirrored into the devices' physical addresses, making it easy to locate a device in the whole topology, by simply knowing its physical address. For instance:

**3.5.12** is the physical address of the bus device number 12, installed along line 5 in area 3

**7.11.4** is the physical address of bus device number 4 on line 11 in area 7

A line coupler connects a secondary line to the backbone line; the device forms an integral part of the secondary line and conventionally assumes the device number "0". The physical address of a line coupler can be, for instance:

**3.5.0** is the physical address of the coupler connecting the secondary line n. 5 to the main line of area 3

The area coupler connects an area's main line to the backbone line; the device is part of the main line and conventionally assumes device number "0" and line number "0". The physical address of an area coupler is, for example:

**3.0.0** is the physical address of the coupler connecting the main line of area 3 to the system's backbone line

The physical address of the transmitting device is always present in a telegram, working as the "source address" of the message.

<h1>3.5.12</h1>	The physical address (area.line.device) is used when programming and diagnosing bus devices.
<h1>2/6/54</h1>	The group address is used when commanding and controlling the bus devices.

To coordinate the performance of several devices over a particular bus function, a so-called group address is used: this is represented by a two levels structure "main group/subgroup" (e.g. "2/15") or by a three level structure "main group/middle group/subgroup" (e.g. "2/6/54"). This type of address is almost exclusively used as a "destination" address for telegrams.

## Power supply

KNX systems work with the 30 Vdc SELV (Safety Extra Low Voltage) voltage, supplied by the bus power supply present on each line; this power feeds the electronic parts of the devices and provides for the transmission of information over the bus. Normally, KNX commands and sensors are exclusively connected to the bus line, while parts of KNX actuators require a separate 230 Vac power supply for commanding connected loads. Some devices may require an auxiliary SELV power supply for their operation.

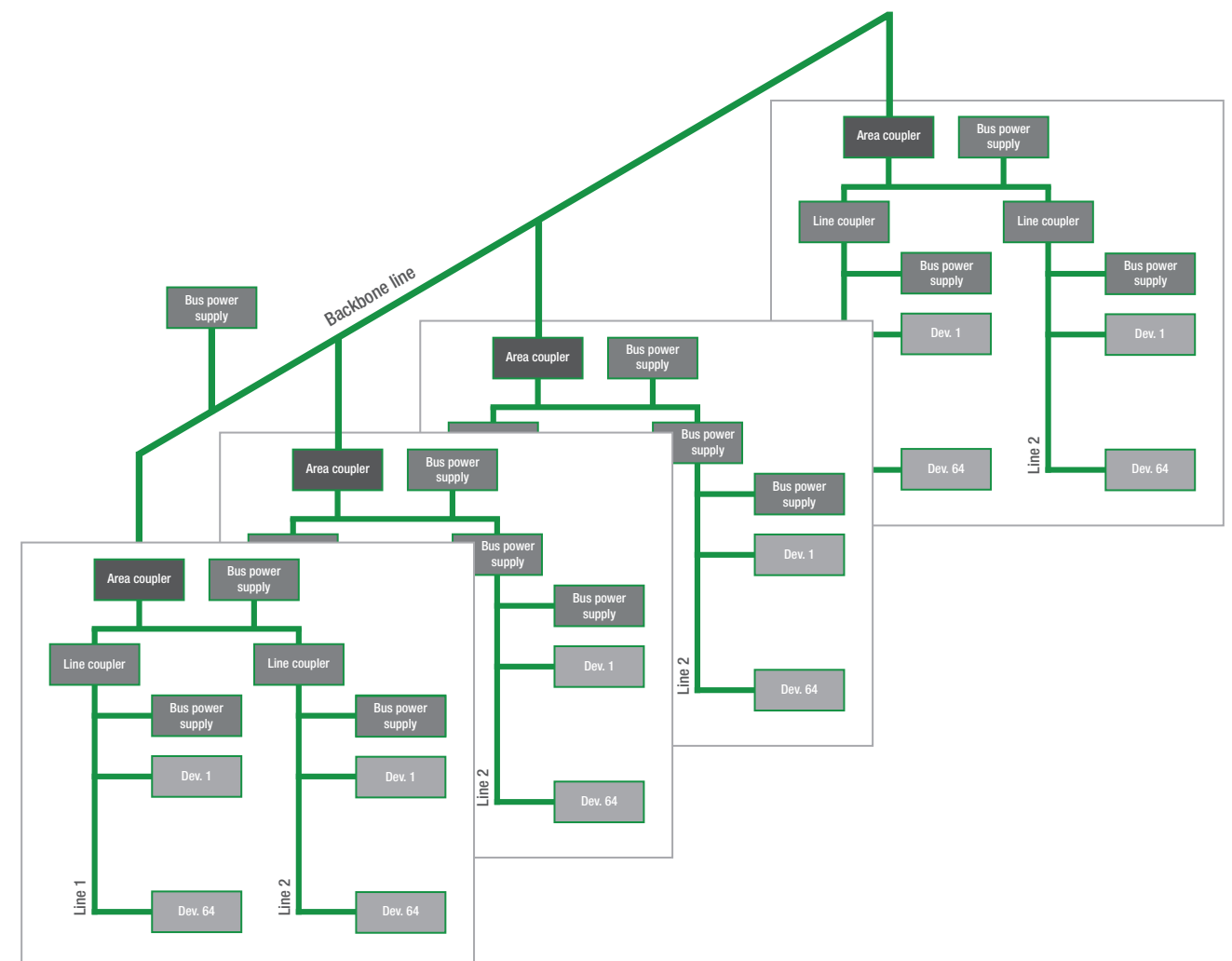

## Normative references

### TECHNICAL SECTION

Norms are, by nature, voluntary application dispositions; anyhow, complying with norms constitutes the best guarantee in the choice of a product for designers, installers and end users. In fact, norms are "state-of-the-art" developments in their technology sector and precisely define quality, performance and safe conditions of use for a product. Beyond safety norms regarding all products, the systems for the control of houses and buildings are more often requested to integrate energetic

efficiency models, consistently abiding to recent tendencies aiming at global system-envelope system efficiency, more so than seek optimization of single parts. KNX represents an open and interoperable system for the automation of houses and buildings, normed at global level thanks to its conformity with international (ISO/IEC 14543-3), European (CENELEC EN 50090, CEN EN 13321-1 e 13321-2), Chinese (GB/Z 20965) and American (ANSI/ASHRAE 135) norms.

Norm	Title	Notes
<b>ISO/IEC 14543-3</b>	<b>Information technology - Home electronic system (HES) architecture</b>	In sight of the great interest towards KNX compatible products and the technology by them consolidated well beyond European markets, the KNX Association took all necessary steps to obtain approval of its own KNX standards at international levels. At the end of 2004, active CENELEC member countries proposed the European EN 50090 norm for ISO/IEC standardization. In November 2006, the KNX protocol and all transmission media (TP, PL, RF and IP) became approved and published under the international ISO/IEC 14543-3-x normative.
<b>EN 50090</b>	<b>Home and Building Electronic Systems (HBES)</b>	In December 2003, the KNX protocol and the two TP (twisted pair) and PL (power line) transmission media were approved by the European national committees and ratified by the CENELEC Bureau Technique under the European EN 50090 norm. The transmission medium KNX RF (radio frequency) was approved the month of may 2006.
<b>CEN EN 13321-1</b>	<b>Open data communication in building automation, controls and building management. Home and building electronic system. Product and system requirements</b>	Since KNX supplies more and more technical specifications used not only for the automation of electrical devices, but also for HVAC (Heating, Ventilation and Air Conditioning) applications, the KNX Association submitted its specifications to CEN for publishing a European normative for building control systems. CEN accepted the proposal and KNX specifications where published by CEN as EN 13321-1 and EN 13321-2.
<b>CEN EN 13321-2</b>	<b>Open data communication in building automation, controls and building management. Home and building electronic systems. KNXnet/IP Communication</b>	
<b>GB/Z 20965</b>	<b>Control network HBES technology specification - Home and building control</b>	The great interest demonstrated by China for KNX products and technology was the main reason for the KNX Association to have the international ISO/IEC 14543 norm translated into Chinese. The Chinese standardization committee SAC TC 124 introduced the KNX standard into China and adopted it under the GB/Z 20965 norm in July 2007.
<b>ANSI/ASHRAE 135</b>	<b>BACnet - A Data Communication Protocol for Building Automation and Control Networks (ANSI Approved)</b>	Even the interfacing of KNX with other automation systems is now internationally standardized: the norms US ANSI/ASHRAE 135 and ISO 16484-5 support mapping between KNX and BACnet.
<b>CEI EN IEC 63044-3</b>	<b>2018 Home and Building Electronic Systems (HBES) and Building Automation and Control Systems (BACS)</b>	Part 3: Electrical safety requirements
<b>CEI EN IEC 63044-5-1</b>	<b>2017 Home and Building Electronic Systems (HBES) and Building Automation and Control Systems (BACS)</b>	Part 5-1: EMC requirements, conditions and test set-up

## Normative references

### TECHNICAL SECTION

#### The EN 50090 norm

The European EN 50090 norm "Home and Building Electronic Systems (HBES)" was developed at CENELEC from the TC 205 Technical Committee, specifically established in 1996 to write norms covering all relevant aspects of electronic systems dedicated to the control of homes and buildings. Parts of the norm were progressively released and published by the standard committee of several European countries giving birth to the national norms about the electronic systems for homes and buildings.

Beyond the requirements for the development of HBES systems and components, aimed at builders, the norm also defines the criteria for designing, installing and testing an HBES system. The KNX standard is entirely compliant with the EN 50090 norm.

Part	Home and Building Electronic Systems (HBES) - Title of the part	Year
<b>EN 50090-1</b>	Part 1: Standardization structure	<b>2011</b>
<b>EN 50090-2-1</b>	Part 2-1: System overview - Architecture	<b>1998</b>
<b>EN 50090-2-2/A2</b>	Part 2-2/A2: System overview - General technical requirements	<b>2008</b>
<b>EN 50090-2-3</b>	Part 2-3: System overview - General functional safety requirements for products intended to be integrated in HBES	<b>2006</b>
<b>EN 50090-3-1</b>	Part 3-1: Aspects of application - Introduction to the application structure	<b>1997</b>
<b>EN 50090-3-2</b>	Part 3-2: Aspects of application - User process for HBES Class 1	<b>2004</b>
<b>EN 50090-3-3</b>	Part 3-3: Aspects of application - HBES Interworking model and common HBES data types	<b>2010</b>
<b>EN 50090-4-1</b>	Part 4-1: Media independent layers - Application layer for HBES Class 1	<b>2006</b>
<b>EN 50090-4-2</b>	Part 4-2: Media independent layers - Transport layer, network layer and general parts of data link layer for HBES Class 1	<b>2005</b>
<b>EN 50090-4-3</b>	Part 4-3: Media independent layers - Communication over IP	<b>2008</b>
<b>EN 50090-5-1</b>	Part 5-1: Media and media dependent layers - Power line for HBES Class 1	<b>2005</b>
<b>EN 50090-5-2</b>	Part 5-2: Media and media dependent layers - Network based on HBES Class 1, Twisted Pair	<b>2005</b>
<b>EN 50090-5-3</b>	Part 5-3: Media and media dependent layers - Radio frequency	<b>2007</b>
<b>EN 50090-7-1</b>	Part 7-1: System management - Management procedures	<b>2005</b>
<b>EN 50090-8</b>	Part 8: Conformity assessment of products	<b>2001</b>
<b>EN 50090-9-1</b>	Part 9-1: Installation requirements - Generic cabling for HBES Class 1 Twisted Pair	<b>2005</b>
<b>CLC/TR 50090-9-2</b>	Part 9-2: Installation requirements - Inspection and testing of HBES installation	<b>2009</b>



# Energy efficiency in buildings

## TECHNICAL SECTION

Based on the fact that buildings in Europe account for over 40% of total energy consumption, the European Union intensified its efforts over the last years so that buildings be projected and re-qualified, thereby restraining consumptions as much as possible. The declared objective is to reduce energy dependence and the emission of polluting and climate-changing gases. The starting point was the publishing of Directive 91 in 2002 about energy performance in building (known as EPBD – Energy Performance Building Directive) - a mandatory implementation for European Union countries – which introduced important new facts, such as the energy performance certification, aimed at informing users about the building’s energy performance and leaving up to national measures the identification of the most appropriate interventions needed to increase energy efficiency. The innovative approach required coordinated interventions on the envelope-system integrated system.

Final energy consumption by sector (EU)

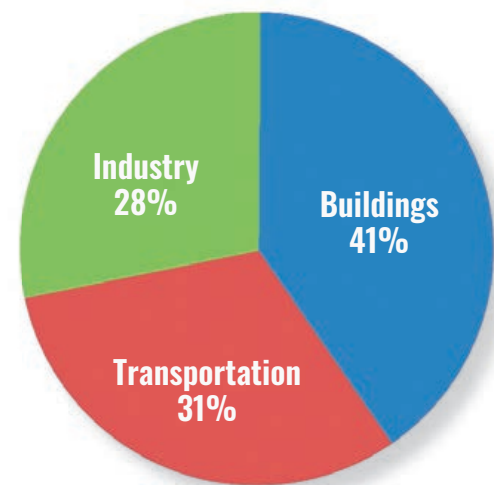

### The EN 15232 norm

Following the Directive 2002/91/EC, the next step is to pay attention to efficiency recovery in individual behaviours and to concentrate on the relationship between the rate of automation in a building’s plan and the corresponding achievable energy saving. This has brought CENELEC to publish the EN 15232 norm, later acknowledged by the standard committee of several European countries. The norm evaluates the savings achievable through the adoption of growing automation levels – both during planning and energy verification operations – and to place buildings in one of four energy efficiency classes: from A (the most efficient) to D (the least efficient).



BACS: Building Automation Control System  
TBM: Technical Building Management System



### A class

A class includes highly energy-efficient buildings, fitted with control and automation systems (BACS) and technical system management (TBM), characterized by high levels of precision and completeness in terms of automatic control.

### B class

B class includes energetically advanced buildings, fitted with control and automation systems (BACS) and technical system management (TBM) allowing a centralized-type of control.

### C class

C class includes buildings, which are standard from an energy point of view and are fitted with basic control and automation systems (BACS). This class is also used as a reference for the calculation of efficiency factors.

### D class

D class includes buildings, which are not energy-efficient, having technical systems exclusively of a traditional type, lacking any kind of automation.

The EN 15232 norm also specifies:

- a structured list of regulation functions, automation and technical management which have a certain effect on the energy efficiency of buildings;
- a method to define minimal requirements to apply for regulation, automation and technical management of buildings of different complexity;
- detailed methods to evaluate the effects of such functions on a specific building;
- a simplified method to reach a first impact estimate of such functions on representative buildings.



### Quality certification

The Ekinex® products described in this catalogue are developed and built in conformity with the quality management system adopted by Ekinex S.p.A. and certified by DNV – Det Norske Veritas – in accordance ISO EN 9001:2008.

### Access through mobile devices

All QR\* codes appearing on product catalogue pages, provide quick access - at any time and from any place – to technical documentation or any other web content published at [www.ekinex.com](http://www.ekinex.com), by using mobile devices such as smart-phones or tablets. In order to decode QR, one simply must upload to his mobile device any freeware application found online.

(\*) QR Code® is a trademark registered by Denso Wave Incorporated

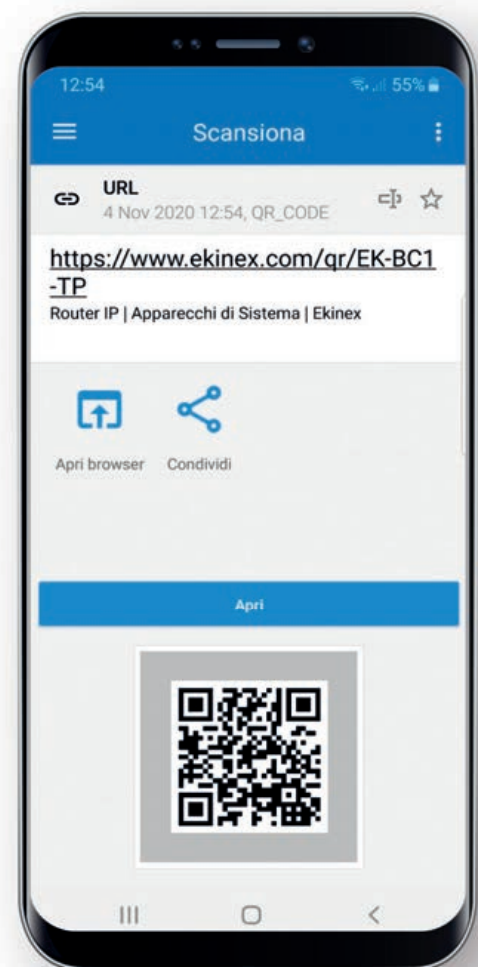

### Documentation on the Web

All tech documents for Ekinex® devices are available for download from the [www.ekinex.com](http://www.ekinex.com) website, without requiring any registration. The search is free, and products may be searched by their code, family or type. The same documentation can quickly be accessed from within the product pages, too.



### ETS application software in several languages

All Ekinex® devices have ETS application software in 4 languages: English, German, French and Italian.

### Single packaging

Ekinex® devices are individually protected against shock & dust by means of a dedicated packaging. The label clearly describes the contents and bears both an (EAN) bar-code and a QR. Inside the packaging, the instructions sheet supplies information for the installation of the product.

## General terms of sale

Valid for the Ekinex® product range.

### 1. DEFINITIONS

1.1 In this General Terms of Sale, the below-mentioned terms assume the following meaning:

- a) "Producer": Ekinex S.p.A. with Head Office in Vaprio d'Agogna (28010 NO), via Novara 37;
- b) "Customer": Professional customer, sole trader or company requesting the purchase of Ekinex® products
- c) "Part" or "Parts": Ekinex S.p.A. and the Customer;
- d) "Order" or "Orders": purchasing order(s), related to Ekinex® products, issued by Customer to Ekinex S.p.A.;
- e) "Products": all Ekinex® products for the control of homes and buildings listed in the Ekinex® product catalogue, be it either printed and/or electronic and on the [www.ekinex.com](http://www.ekinex.com) site.
- f) "General Conditions": the general terms of sales, as indicated hereunder.

### 2. SCOPE

2.1. These General Terms of Sale discipline all purchasing contracts, concerning Ekinex® products, set between Parts;

2.2. The Customer cannot plea nor object different conditions other than those specified in General Terms of Sale. Hence, any contingent conditions requested by the Customer, be it at order time or during any other contractual phase, or after accepting / becoming aware of our General Terms, or mentioned in the Customer's General Terms of Purchase, will be void. The Producer's implementation of the Order, even partially, or any other fulfilments in favour of the Customer are not valid and cannot be interpreted as tacit or implicit acceptance of whatsoever contractual condition other than those indicated in these General Terms of Sale, unless explicitly accepted in writing from Ekinex S.p.A. Even in the case of agreed exceptions accepted in writing, the present Terms of Sale will continue to be applicable to all other contractual parts not included in the exception.

2.3. The General Terms of Sale are exclusively applicable to contractual relationships between Ekinex S.p.A. and professional operators, thus not covered by the Italian D.Lgs. n. 206 (Consumer Code) dated September 6th, 2005 and all further modifications.

2.4. It is the faculty of Ekinex S.p.A. to modify the present General Terms of Sale at any moment and without any notice. Each contract will be regulated by the General Terms of Sale in force at the moment of acceptance of the Order issued by the Customer.

### 3. CONTRACT FORMATION

3.1. Acceptance of the offer on the part of the Customer or the order confirmation on the part of Ekinex S.p.A., no matter in what form, entail the application of the General Terms of Sale.

3.2. Any offer submitted by agents, representatives or Ekinex S.p.A. business partners are not binding for Ekinex S.p.A. until she confirms them in writing

All sale offers formulated by Ekinex S.p.A. have a validity of 30 days from date-of-issue and are limited to the complete supply of products thereby quoted. After the above-mentioned deadline, the sale offer will no longer be valid.

3.3. The Order sent from the Customer to Ekinex S.p.A. constitutes a binding, irrevocable contractual proposal for a period of three months, starting from the moment Ekinex S.p.A. becomes aware of its existence. During the period of three months, Ekinex S.p.A. reserves the right – at its sole discretion – to either accept or reject the Order, informing the Customer of the decision taken.

Should Ekinex S.p.A.'s order confirmation differ from the Order sent by the Customer (for example, in terms of product quantity, prices, discounts, delivery terms, shipping), such confirmation will count as a counter-proposal of Ekinex S.p.A., which will have to be explicitly accepted by the Customer in order for the contract to be concluded.

3.4. By sending an Order, the Customer acknowledges and declares to have carefully examined all the indications submitted to him during the purchasing phase and he declares to unreservedly accept the present General Terms of Sale.

3.5. The acceptance will be made official by a confirmation e-mail message sent to the electronic mail address indicated by the Customer. The confirmation message will bear Order date and time and a "Customer Order Number" to be used in all subsequent communications with Ekinex S.p.A. The Customer will be able to monitor the status of his Order at any time either contacting Ekinex S.p.A. by phone at (+39) 0321 1828980 or by sending an e-mail to [sales@ekinex.com](mailto:sales@ekinex.com).

3.6. Should the Customer require Order cancellation before its acceptance or execution on the part of Ekinex S.p.A., the latter may ask the Customer to reimburse any expenses or duties sustained for the handling of the Order – in full or in part –, as well as reimbursement for any damages.

### 4. PRODUCT AVAILABILITY

4.1. Ekinex S.p.A. reserves the right to modify, without any notice, the Ekinex® product catalogue, as well as the technical characteristics of its products.

4.2. Should one of the requested products be unavailable, Ekinex S.p.A. commits to contact the Customer within 20 working days from Order receipt, informing the Customer at his e-mail address about the unavailability and suggesting any alternatives. In this case, the Customer may select to wait for Order dispatch, as long as Ekinex S.p.A. believes she may trace the missing product on the market, or cancel the order, eventually obtaining reimbursement for prepaid and missing products.

### 5. PAYMENT METHODS

5.1. Product prices will refer to the price list in force at sale-offer acceptance on the part of the Customer or at issuance of Order confirmation on the part of Ekinex S.p.A.

Ekinex S.p.A. reserves the right to modify its price lists at any time, after written communication to the Customer should costs increase for raw material, manpower or any other factor which may cause a relevant rise in production costs.

Product prices are always Free Carrier (FCA Incoterms 2010) and, therefore, any risks related to the shipping pass onto the Customer's side the moment that products are handed in to the carrier, unless different agreements are reached between Parts in advance.

5.2. Payments will have to be made in accordance with the indications contained in the sale offer or in the order confirmation. Payments, as well as any other due sum, will be made to the Ekinex S.p.A. Head office address and in Euro, unless otherwise agreed between Parts.

5.3. Any delay or irregularity in payments will confer Ekinex S.p.A. the right to:

- a) suspend ongoing supplies, even if not related to the payment in question;
  - b) modify the form of payment and discounts for further supplies, requesting advance payments or the issuance of further guarantees as necessary;
  - c) request, starting from the planned payment expiry date and without need of a formal notice of default, arrears due on the unpaid sums, calculated according to current law terms for commercial transactions (in particular, as indicated by the Italian D.Lgs. 231/2002 and further integrations). In any case, Ekinex S.p.A. reserves the right to request compensation for the highest damage incurred.
- Furthermore, in all the above cases, any sum due to Ekinex S.p.A. on whatever basis becomes immediately collectable. The Customer will compel to pay the products in full even if any exceptions, objections or disputes should arise. Any argument will be defined only after payment of all monies due.

# General terms of sale

## 6 TRANSPORTATION AND DELIVERY OF PRODUCTS

6.1. Delivery of goods is understood to be Free Carrier (FC Incoterms) and, therefore, any risk related to the supply pass onto the Customer the moment that products are delivered to the carrier, unless previously arranged differently in writing between parts.

6.2. Delivery terms, except where explicitly agreed, are purely indicative.

In the case that order execution is hindered by force majeure circumstances, irregular or missing procurement of prime materials or by other unpredictable circumstances, delivery terms will be considered deferred and new terms will be established between parts without possibility to request any compensation and/or damages for delay in the delivery.

6.3. Upon delivery of goods from the carrier, the Customer is due to check that the content of delivered packages corresponds to order and to details in the invoice transmitted by mail. Any damage to packaging and/or product or any discrepancy in the number of packages must be notified within 3 working days from delivery to customer service of Ekinex S.p.A. at the email address sales@ekinex.com. After such term, the Customer may no longer advance any complaint in matter of packaging conditions or number of parcels received.

## 7. WARRANTY

7.1. Ekinex S.p.A. guarantees the conformity of its products in terms of legislation and technical regulations enforced in Italy.

7.2. Ekinex S.p.A. guarantees that the supplied products correspond, in terms of quality and type, to whatever established by the contract, and to be free from defects that may render them unsuitable for the use which they are expressly meant for.

The guarantee for manufacturing defects is limited to the sole defects that may be attributable to materials used or to design and production problems attributable to Ekinex S.p.A.

All Ekinex® products sold by Ekinex S.p.A. come with a guarantee of proper operation and a guarantee for design and production defects, valid for a 24 months period from delivery, except for parts subject to standard wear & tear. After such period, the guarantee ceases, even if the products have not been put to work for any reason.

The operability of guarantees on the products is subject to the condition precedent of full payment received.

7.3. The above-said guarantee is operative provided that the products be correctly stored and used in conformity with the instructions included in the General Catalogue and the technical sheets supplied by Ekinex S.p.A., that no repair, modification or alteration be applied without prior written consent of Ekinex S.p.A. and that ascertained defects not be caused by chemical agents or electricity. The Customer will report any faults or defects in writing within 8 days from product consignment, while any hidden defects and/or malfunctioning (which can only be detected with use) will have to be reported within 8 days from discovery and, in any case, never beyond the guarantee's period of validity.

The guarantee is void in case the malfunctioning is caused by software installed on the product: overload, interruption or suspension of electricity.

7.4. Complaints will be forwarded in writing to Ekinex S.p.A., in accordance with instructions and modalities supplied by the latter (see quick-replacement procedure in the General Catalogue), specifying in detail the faults or discrepancies ascertained.

The Customer will lose all guarantee rights, should he not allow for reasonable checks that Ekinex S.p.A. may deem necessary or lack to return the faulty product within 10 days from request. Following regular Customer complaint, Ekinex S.p.A., at her choice, may: a) repair the faulty products: b) supply, free of charge, the Customer (DAP Incoterms 2010) with products of the same kind and quantity of those deemed faulty; c) issue a credit note in favour of Customer for the same amount of the original invoice of returned products. In such cases, Ekinex S.p.A. may request the return of faulty products, which will become her property. Unless arranged differently between parts, it is understood that all expenses related to the interventions of Ekinex S.p.A.'s technical assistance will be sustained by the latter.

Both in case of replacement and/or repair of the products or the defective components, the guarantee will continue to elapse from its original term which, therefore, remains unchanged and will not be extended.

7.5. In the case where defects observed on the products are not imputable to the responsibility of Ekinex S.p.A., all repair and substitution expenses thereby incurred shall be accounted for and invoiced to the Customer. The guarantee referred to in this article absorbs and replaces legal guarantees for faults and conformity and excludes any other responsibility on the part of Ekinex S.p.A. originating, in any form or way, from its finished products: in particular, the Customer will not submit any other request for reimbursement and, in no case, Ekinex S.p.A. shall be deemed responsible for indirect or consequential damage.

## 8. INDUSTRIAL PROPERTY

8.1. Ekinex S.p.A. remains exclusive proprietor of patents, drawings, projects and anything else used for the realization of products, and the Customer commits not to distribute them to third parties, not to reproduce them and not to use them. Should the realization of products be carried out by Ekinex S.p.A. by specific request and technical documentation of the Customer, Ekinex S.p.A. assumes no responsibility for the violation of third-party industrial property rights, which will be exclusively accountable to the Customer who commits to guarantee and to keep Ekinex S.p.A. released and indemnified from any claim against her. 8.2. The Customer commits to use Ekinex S.p.A. trademarks only for identification, advertising and sale purposes, abstaining from registering them or from having them registered by others without written consent from Ekinex S.p.A.

## 9. DAMAGE COMPENSATION

9.1. The responsibility of Ekinex S.p.A., deriving from either the implementation or non-implementation of the contract, or guarantee, or tort claim, or objective responsibility, will never exceed the value of the product to which it relates. Under no circumstance, Ekinex S.p.A. will be held responsible for neither missed or loss of profits, nor for missed use or technical halt of the product or any associated machinery, nor for Customer and/or third-parties complaints related to such damage, nor for any other type of indirect or consequential damage.

## 10. PRIVACY

10.1. The Customer accepts to (i) treat the information/data/drawings/know-how/documentation received and/or comprehended from Ekinex S.p.A. as reserved; (ii) limit the use of such information/documentation and access to them solely for contractual purposes. The reserved information/documentation will not be reproduced without written consent of Ekinex S.p.A. and any copies of them will be immediately surrendered upon Ekinex S.p.A. request.

Above provisions do not apply to information which: (i) is public or become public for divulgation not performed by the Customer, his employees or collaborators (ii) were in the hands of the Customer before he received them from Ekinex S.p.A. or (iii) were divulged by sources who are not subordinate to the same restrictions as the Customer in terms of use, or (iv) can be disclosed to third parties following a written authorization of Ekinex S.p.A.

## 11. SETTLEMENT OF DISPUTES

11.1. The present General Terms and related contracts of supply shall be disciplined by the Italian law. Any dispute related to or in any way connected to contracts under the present General Terms, will fall under exclusive jurisdiction of the Court of Novara (Italy).

## 12. RESTRICTIVE CLAUSES

12.1 In accordance with articles 1341 and 1342 of the Italian civil code, the Customer expressly declares to approve the following clauses: 2. Scope; 5. Payment Methods; 6. Transportation and delivery of products; 7. Warranty; 9. Damage compensation; 11 Settlement of disputes.

<b>EK-112-TP</b>	Bus cable - bus connection	241
<b>EK-114-TP</b>	Bus cable - bus connection and spare pair	241
<b>EK-A71</b>	Adapter for double plate with a Form or Flank frame	134
<b>EK-A71-1-NF</b>	Adapter for Deep double plate	134
<b>EK-A71-1-NF</b>	Adapter for double plate without frame (NF series)	137
<b>EK-A71-1-NFW</b>	Adapter for double plate without frame (NF series) - white profile	134
<b>EK-A71-5-NF</b>	Adapter for Deep double plate - Package 5 pcs.	134
<b>EK-A71-5-NF</b>	Adapter for double plate without frame (NF series) - Package 5 pcs.	137
<b>EK-A71-5-NFW</b>	Adapter for double plate without frame (NF series) - white profile - Package 5 pcs.	134
<b>EK-AB1-TP</b>	640 mA bus power supply	183
<b>EK-ACC-L100</b>	Software License up to 100 reader	105
<b>EK-ACC-L12</b>	Software License up to 12 reader	105
<b>EK-ACC-L200</b>	Software License up to 200 reader	105
<b>EK-ACC-L25</b>	Software License up to 25 reader	105
<b>EK-ACC-L50</b>	Software License up to 50 reader	105
<b>EK-ACC-LC</b>	Client License for additional programming workstation	105
<b>EK-AG1-TP</b>	640 mA bus power supply with 30 Vdc auxiliary output	183
<b>EK-B71-1-NF</b>	Adapter for Deep triple plate	138
<b>EK-B71-5-NF</b>	Adapter for Deep double plate - Package 5 pcs.	137
<b>EK-BA1-TP</b>	Line / area coupler	176
<b>EK-BB1-TP</b>	IP interface and IP router	187
<b>EK-BC1-TP</b>	IP interface and IP router	188
<b>EK-BD1-TP</b>	USB interface	185
<b>EK-BG1-TP</b>	Gateway DALI - KNX	230
<b>EK-BH1-TP-485</b>	Gateway Modbus RS485 - KNX	224
<b>EK-BH1-TP-TCP</b>	Gateway Modbus TCP/IP - KNX	225
<b>EK-BJ1-TP-IP</b>	Gateway BACnet - KNX	226
<b>EK-BJ1-TP-MSTP</b>	Gateway DMX - KNX	226
<b>EK-BK1-TP</b>	Gateway M-Bus - KNX	227
<b>EK-BM1-TP-160</b>	Gateway PROFINET - KNX - max 160 slave devices	228
<b>EK-BM1-TP-20</b>	Gateway PROFINET - KNX - max 20 slave devices	228
<b>EK-BM1-TP-40</b>	Gateway PROFINET - KNX - max 40 slave devices	228
<b>EK-BM1-TP-80</b>	Gateway PROFINET - KNX - max 80 slave devices	228
<b>EK-BN1-TP</b>	Gateway PROFINET - KNX	229
<b>EK-BO1-TP-RMA</b>	Modbus / KNX interface for RDZ air handling units	222
<b>EK-BQ1-TP</b>	CoolMasterNet with integrated KNX module	232
<b>EK-BW1-TP</b>	Voice control interface - KNX	231

<b>EK-CA1-TP</b>	8-fold binary input	198
<b>EK-CBP-NTM</b>	Color Box Pro - Fenix NTM®	259
<b>EK-CBP-PLA-MET</b>	Color Box Pro - Plastic and Metal	259
<b>EK-CC2-TP</b>	Universal interface 2 IN, 2 OUT	191
<b>EK-CC-FEN</b>	Color Ring - Fenix NTM®	258
<b>EK-CC-MET</b>	Color Ring - Metal	258
<b>EK-CC-PLA</b>	Color Ring - Plastic	258
<b>EK-CD2-TP</b>	Universal interface 4 IN, 4 OUT	191
<b>EK-CE2-TP</b>	Universal interface 4 IN, 2 OUT (relay 5A)	193
<b>EK-CF2-TP</b>	Load monitoring and control interface	194
<b>EK-CG2-TP</b>	Universal interface 4 configurable IN, 4 OUT	192
<b>EK-D2C-...</b>	Deep plate with 120 x 60 mm window	146
<b>EK-D2E</b>	Deep double plate - window 45 x 45 mm (2)	137
<b>EK-D2F</b>	Deep double plate - window 45 x 45 mm (1) - window 60 x 60 mm (1)	137
<b>EK-D2G-...</b>	Deep double plate - window 55 x 55 mm (1) - window 60 x 60 mm (1)	137
<b>EK-D2P-...</b>	Deep double plate - window 55 x 55 mm (2)	137
<b>EK-D2S-...</b>	Deep double plate - window 60 x 60 mm (2)	137
<b>EK-D3P-...</b>	Deep triple plate - window 55 x 55 mm (3)	138
<b>EK-D3S-...</b>	Deep triple plate - window 60 x 60 mm (3)	138
<b>EK-DEL-5FR-...</b>	Aluminium frame for Delégo panel 5"	251
<b>EK-DEL-5SPAN</b>	Delégo panel 5" - black panel	251
<b>EK-DEL-5SPANWH</b>	Delégo panel 5" - white panel	251
<b>EK-DEL-8SPAN</b>	Delégo panel 8" - black panel	251
<b>EK-DEL-8SPANWH</b>	Delégo panel 8" - white panel	251
<b>EK-DEL-SRV-ADV-TP</b>	Delégo server - ADVANCED	250
<b>EK-DEL-SRV-BAS-TP</b>	DELÉGO SERVER - BASIC	250
<b>EK-DEL-SRV-PRM-TP</b>	Delégo server - PREMIUM	250
<b>EK-DEL-TBK1</b>	Tosibox® Key cryptographic micro-controller that realizes 1 client PC + 1 mobile client	108
<b>EK-DEL-TBL1</b>	Router Tosibox® Lock 150	106
<b>EK-DEL-TBL5-SIM</b>	Router Tosibox® Lock 500i	106
<b>EK-DEL-TBMC1</b>	Additional license for Tosibox® Key with 1 mobile client	107
<b>EK-DEL-TBMC10</b>	Additional license for Tosibox® Key with 10 mobile client	107
<b>EK-DEL-TBMC5</b>	Additional license for Tosibox® Key with 5 mobile client	107
<b>EK-DEL-TBSK1</b>	Tosibox® SoftKey software key to be combined with a key, with Sub Key function	107
<b>EK-DEL-UPGR-AP</b>	Upgrade server Delégo ADVANCED-PREMIUM	250
<b>EK-DEL-UPGR-BA</b>	Upgrade server Delégo BASIC-ADVANCED	250





## Index by code

<b>EK-P2E-...</b>	Double plate - window 45 x 45 mm (2)	134
<b>EK-P2F-...</b>	Double plate - window 45 x 45 mm (1) - window 60 x 60 mm (1)	134
<b>EK-P2G-...</b>	Double plate - window 55 x 55 mm (1) - window 60 x 60 mm (1)	134
<b>EK-P2P-...</b>	Double plate - window 55 x 55 mm (2)	134
<b>EK-P2S-...</b>	Double plate - window 60 x 60 mm (2)	134
<b>EK-POC-BOX-EN</b>	Pocket Box	258
<b>EK-PQG-...</b>	Square plate - window 55 x 55 mm	132
<b>EK-PQP-...</b>	Square plate - window 45 x 45 mm	132
<b>EK-PQS-...</b>	Square plate - window 60 x 60 mm	132
<b>EK-PRG-...</b>	Rectangular plate - window 55 x 55 mm	133
<b>EK-PRP-...</b>	Rectangular plate - window 45 x 45 mm	133
<b>EK-PRS</b>	Rectangular plate - window 60 x 60 mm	133
<b>EK-PSC-DE</b>	Rough white cover - Schuko	128
<b>EK-PSC-DE-USB-...</b>	Painted cover - Schuko USB	128
<b>EK-PSC-DE-...</b>	Painted cover - Schuko	128
<b>EK-PSC-DE-USB</b>	Rough white cover - Schuko USB	128
<b>EK-PSC-IT</b>	Rough white cover - Italian	127
<b>EK-PSC-IT-...</b>	Painted cover - Italian	127
<b>EK-PSC-IT-USB</b>	Rough white cover - Italian USB	127
<b>EK-PSC-IT-USB-...</b>	Painted cover - Italian USB	127
<b>EK-PWS-DE</b>	Power socket - Schuko	128
<b>EK-PWS-DE-USB</b>	Power socket - Schuko USB	128
<b>EK-PWS-IT</b>	Power socket - Italian	127
<b>EK-PWS-IT-USB</b>	Power socket - Italian USB	127
<b>EK-QR6-IR</b>	IR Remote Controller (presence sensors)	67-68-69
<b>EK-QS3</b>	Support for external mounting (presence sensors)	67-68-69
<b>EK-S2C-...</b>	Surface plate with 120 x 60 mm window	147
<b>EK-S2E</b>	Surface double plate - window 45 x 45 mm (2)	141
<b>EK-S2F</b>	Surface double plate - window 45 x 45 mm (1) - window 60 x 60 mm (1)	141
<b>EK-S2G-...</b>	Surface double plate - window 55 x 55 mm (1) - window 60 x 60 mm (1)	141
<b>EK-S2P-...</b>	Surface double plate - window 55 x 55 mm (2)	141
<b>EK-S2S-...</b>	Surface double plate - window 60 x 60 mm (2)	141
<b>EK-SB4-20VENTI</b>	Style box 20venti series	260
<b>EK-SB4-5PAN</b>	Style box Delégo panel 5"	260
<b>EK-SB4-71-DEEP</b>	Style box 71 series - Deep	260
<b>EK-SB4-71-SUR-FACE</b>	Style box 71 series - Surface	260
<b>EK-SB4-FF-FORM</b>	Style box FF series - Form	260

<b>EK-SC1-01</b>	Style Case	260
<b>EK-SM2-CHA</b>	Double supports for installation with 60 mm device centre distance - vertical	145
<b>EK-SM2-CHB</b>	Double supports for installation with 60 mm device centre distance - vertical	145
<b>EK-SM2-CHC</b>	Double supports for installation with 60 mm device centre distance - vertical	145
<b>EK-SM2-CHD</b>	Double supports for installation with 60 mm device centre distance - horizontal	145
<b>EK-SM2-CHE</b>	Double supports for installation with 60 mm device centre distance - horizontal	145
<b>EK-SM2-CHF</b>	Double supports for installation with 60 mm device centre distance - horizontal	145
<b>EK-SM2-TP</b>	Movement sensor	66
<b>EK-SMG-35-1</b>	Support for DIN-rail mounting	196
<b>EK-SMG-35-5</b>	Support for DIN-rail mounting - Package 5 pcs.	196
<b>EK-SMQ</b>	Square mounting support - thermostats and Touch&See FF series	149
<b>EK-SMQ-71</b>	Square mounting support - devices of 20venti or 71 series and 4-fold pushbutton of FF series	149
<b>EK-SMR</b>	Rectangular mounting support - 6-fold pushbutton and Touch&See with 2-fold pushbutton of FF series	149
<b>EK-SMR-71</b>	Rectangular mounting support - devices of 20venti or 71 series	149
<b>EK-SP-TX2</b>	Adapter for card holder and card reader	100
<b>EK-SP-TX2</b>	Adapter for card holder and card reader	100
<b>EK-SQG-...</b>	Surface square plate - window 55 x 55 mm	139
<b>EK-SQP-...</b>	Surface square plate - window 45 x 45 mm	139
<b>EK-SQS-...</b>	Surface square plate - window 60 x 60 mm	139
<b>EK-SQT-...</b>	Surface square plate - window 30 x 60 mm	139
<b>EK-SRG-...</b>	Surface rectangular plate - window 68 x 45 mm	140
<b>EK-SRS</b>	Surface rectangular plate - window 60 x 60 mm	140
<b>EK-STC-10K-3435</b>	NTC 10 kΩ temperature sensors - contact	221
<b>EK-S TE-10K-3435</b>	NTC 10 kΩ temperature sensors - outdoor	221
<b>EK-STI-10K-3435</b>	NTC 10 kΩ temperature sensors - immersion	221
<b>EK-STL-10K-3435</b>	NTC 10 kΩ temperature sensors - air mass	221
<b>EK-T1Q-...</b>	1 Square rocker for pushbuttons - 71 series	113
<b>EK-T1Q-...-ES2</b>	Full front cover for Multisensor EK-ES2-TP - 71 Series	114
<b>EK-T1Q-...-ET2</b>	Full front cover for Multisensor EK-ET2-TP - 71 Series	114
<b>EK-T2B-20-BT...</b>	1 Rectangular rocker for pushbuttons (dimmer) - 20venti series	109
<b>EK-T2R-...</b>	2 Rectangular vertical rockers for pushbuttons - 71 series	113
<b>EK-T4Q-...</b>	4 Square rockers for pushbuttons - 71 series	113
<b>EK-T4R-...</b>	4 Rectangular horizontal rockers for pushbuttons - 71 series	113
<b>EK-T4R-20-BL...</b>	4 Rectangular rockers for pushbuttons (symbols/texts backlit) 20venti series	109
<b>EK-T4R-20-BT...</b>	4 Rectangular rockers for pushbuttons (LED) - 20venti series	109
<b>EK-TA-05A</b>	Current transformer (TA) for EK-CF2-TP interface - 0...5	195
<b>EK-TA-20A</b>	Current transformer (TA) for EK-CF2-TP interface - 0...20	195

<b>EK-TA-30A</b>	Current transformer (TA) for EK-CF2-TP interface - 0...30	195
<b>EK-TA-40A</b>	Current transformer (TA) for EK-CF2-TP interface - 0...40	195
<b>EK-TA-50A</b>	Current transformer (TA) for EK-CF2-TP interface - 0...50	195
<b>EK-TA-60A</b>	Current transformer (TA) for EK-CF2-TP interface - 0...60	195
<b>EK-TAQ</b>	Adapter for square plate with a Form or Flank frame	132
<b>EK-TAQ-1-NF</b>	Adapter for square plate without frame ('NF series)	132
<b>EK-TAQ-1-NF</b>	Adapter for Deep square plate	135
<b>EK-TAQ-1-NFW</b>	Adapter for square plate without frame ('NF series) - white profile	132
<b>EK-TAQ-5-NF</b>	Adapter for square plate without frame ('NF series) - Package 5 pcs.	132
<b>EK-TAQ-5-NF</b>	Adapter for Deep square plate - Package 5 pcs.	135
<b>EK-TAQ-5-NFW</b>	Adapter for square plate without frame ('NF series) - white profile - Package 5 pcs.	132
<b>EK-TAR</b>	Adapter for rectangular plate with a Form or Flank frame	133
<b>EK-TAR-1-NF</b>	Adapter for rectangular plate without frame ('NF series)	133
<b>EK-TAR-1-NF</b>	Adapter for Deep rectangular plate	136
<b>EK-TAR-1-NFW</b>	Adapter for rectangular plate without frame ('NF series) - white profile	133
<b>EK-TAR-5-NF</b>	Adapter for rectangular plate without frame ('NF series) - Package 5 pcs.	133
<b>EK-TAR-5-NF</b>	Adapter for Deep rectangular plate - Package 5 pcs.	136
<b>EK-TAR-5-NFW</b>	Adapter for rectangular plate without frame ('NF series) - white profile - Package 5 pcs.	133
<b>EK-TAS-D-1</b>	Adapter for Surface double plate	141
<b>EK-TAS-D-5</b>	Adapter for Surface double plate - Package 5 pcs.	141
<b>EK-TAS-Q-1</b>	Adapter for Surface square plate	139
<b>EK-TAS-Q-5</b>	Adapter for Surface square plate - Package 5 pcs.	139
<b>EK-TAS-R-1</b>	Adapter for Surface rectangular plate	140
<b>EK-TAS-R-5</b>	Adapter for Surface square plate - Package 5 pcs.	140
<b>EK-TBL5</b>	Router Tosibox® Lock 500	106
<b>EK-TCA-TP</b>	Tech Case advanced version	261
<b>EK-TCB-TP</b>	Tech Case basic version	261
<b>EK-TCC-10</b>	Smart-card - Client logo	105
<b>EK-TCE-10</b>	Smart-card - Ekinex logo	105
<b>EK-TH2-TP</b>	Card holder	103
<b>EK-TM1-TP</b>	Time / astronomical digital switch	184
<b>EK-TP2-TP</b>	Cards programmer	104
<b>EK-TPBOX-TP</b>	Desktop cards programmer kit	105
<b>EK-TQQ-...</b>	4 Square rockers for 4-fold pushbuttons - FF series	110
<b>EK-TQQ-...</b>	Square rockers for 6-fold pushbuttons and Touch&See - FF series	111
<b>EK-TQQ-...-EP2</b>	Set 2 square rockers for room thermostats - FF series	112
<b>EK-TR2-TP</b>	Card reader	102

<b>EK-TRO-...</b>	4 Rectangular horizontal rockers for 4-fold pushbuttons - FF series	110
<b>EK-TRV-...</b>	2 Rectangular vertical rockers for 4-fold pushbuttons - FF series	110

## Index by code



## Index by description

1 channel DALI Dimmer	<b>EK-GH1-DL</b>	211
1 Rectangular rocker for pushbuttons (dimmer) - 20venti series	<b>EK-T2B-20-BT...</b>	109
1 Square rocker for pushbuttons - 71 series	<b>EK-T1Q-...</b>	113
16-fold binary output/8-fold blind actuator	<b>EK-FF1-TP</b>	203
2 Rectangular vertical rockers for 4-fold pushbuttons - FF series	<b>EK-TRV-...</b>	110
2 Rectangular vertical rockers for pushbuttons - 71 series	<b>EK-T2R-...</b>	113
2-fold dimming actuator	<b>EK-GA1-TP</b>	208
4 channels DALI Dimmer	<b>EK-GL1-DL</b>	212
4 channels DALI Dimmer 230 Vac	<b>EK-G01-DL</b>	213
4 Rectangular horizontal rockers for 4-fold pushbuttons - FF series	<b>EK-TRO-...</b>	110
4 Rectangular horizontal rockers for pushbuttons - 71 series	<b>EK-T4R-...</b>	113
4 Rectangular rockers for pushbuttons (LED) - 20venti series	<b>EK-T4R-20-BT...</b>	109
4 Rectangular rockers for pushbuttons (symbols/texts backlit) 20venti series	<b>EK-T4R-20-BL...</b>	109
4 Square rockers for 4-fold pushbuttons - FF series	<b>EK-TQQ-...</b>	110
4 Square rockers for pushbuttons - 71 series	<b>EK-T4Q-...</b>	113
4-fold 0-10 V actuator	<b>EK-GF1-TP</b>	210
4-fold basic pushbutton - 71 series - mounting with square frame of Form or Flank series	<b>EK-E22-TP</b>	86
4-fold basic pushbutton - 71 series - mounting without frame (NF series)	<b>EK-E22-TP-NF</b>	86
4-fold basic pushbutton - 71 series - mounting without frame (NF series) - white profile	<b>EK-E22-TP-NFW</b>	86
4-fold basic pushbutton - FF series mounting with square frame of Form or Flank series	<b>EK-E32-TP</b>	46
4-fold basic pushbutton - FF series mounting without frame (NF series)	<b>EK-E32-TP-NF</b>	46
4-fold basic pushbutton - FF series mounting without frame (NF series) - white profile	<b>EK-E32-TP-NFW</b>	46
4-fold basic pushbutton and room thermostat for rectangular wall-box - 71 series - mounting with square frame of Form or Flank series	<b>EK-E22-TP-R</b>	87
4-fold basic pushbutton and room thermostat for rectangular wall-box - 71 series - mounting without frame (NF series)	<b>EK-E22-TP-NF-R</b>	87
4-fold basic pushbutton and room thermostat for rectangular wall-box - 71 series - mounting without frame (NF series) - white profile	<b>EK-E22-TP-NFW-R</b>	87
4-fold binary output	<b>EK-FA1-TP</b>	200
4-fold pushbutton (left) with backlit text/symbols and proximity sensor - 20venti series	<b>EK-E20-TP-4TS-P</b>	28
4-fold pushbutton (right) with backlit text/symbols and proximity sensor - 20venti series	<b>EK-E20-TP-4TD-P</b>	28
4-fold pushbutton and room thermostat - 71 series - mounting with square frame of Form or Flank series - blue / green led	<b>EK-E12-TP</b>	88
4-fold pushbutton and room thermostat - 71 series - mounting with square frame of Form or Flank series - red / white led	<b>EK-E12-TP-RW</b>	88
4-fold pushbutton and room thermostat - 71 series - mounting without frame (NF series) - blue / green led	<b>EK-E12-TP-BG-NF</b>	88
4-fold pushbutton and room thermostat - 71 series - mounting without frame (NF series) - blue / green led - white profile	<b>EK-E12-TP-BG-NFW</b>	88
4-fold pushbutton and room thermostat - 71 series - mounting without frame (NF series) - red / white led	<b>EK-E12-TP-RW-NF</b>	88

4-fold pushbutton and room thermostat - 71 series - mounting without frame (NF series) - red / white led - white profile	<b>EK-E12-TP-RW-NFW</b>	88
4-fold pushbutton and room thermostat - FF series - mounting with square frame of Form or Flank series - blue / green led	<b>EK-ED2-TP</b>	47
4-fold pushbutton and room thermostat - FF series - mounting with square frame of Form or Flank series - red / white led	<b>EK-ED2-TP-RW</b>	47
4-fold pushbutton and room thermostat - FF series - mounting without frame (NF series) - blue / green led	<b>EK-ED2-TP-BG-NF</b>	47
4-fold pushbutton and room thermostat - FF series - mounting without frame (NF series) - blue / green led - white profile	<b>EK-ED2-TP-BG-NFW</b>	47
4-fold pushbutton and room thermostat - FF series - mounting without frame (NF series) - red / white led	<b>EK-ED2-TP-RW-NF</b>	47
4-fold pushbutton and room thermostat - FF series - mounting without frame (NF series) - red / white led - white profile	<b>EK-ED2-TP-RW-NFW</b>	47
4-fold pushbutton and room thermostat for rectangular wall-box - 71 series - mounting with square frame of Form or Flank series - blue / green led	<b>EK-E12-TP-R</b>	89
4-fold pushbutton and room thermostat for rectangular wall-box - 71 series - mounting with square frame of Form or Flank series - red / white led	<b>EK-E12-TP-RW-R</b>	89
4-fold pushbutton and room thermostat for rectangular wall-box - 71 series - mounting without frame (NF series) - blue / green led	<b>EK-E12-TP-BG-NF-R</b>	89
4-fold pushbutton and room thermostat for rectangular wall-box - 71 series - mounting without frame (NF series) - blue / green led - white profile	<b>EK-E12-TP-BG-NFW-R</b>	89
4-fold pushbutton and room thermostat for rectangular wall-box - 71 series - mounting without frame (NF series) - red / white led	<b>EK-E12-TP-RW-NF-R</b>	89
4-fold pushbutton and room thermostat for rectangular wall-box - 71 series - mounting without frame (NF series) - red / white led - white profile	<b>EK-E12-TP-RW-NFW-R</b>	89
4-fold RGBW LED dimmer	<b>EK-GC1-TP</b>	209
6 A MID three phase energy meter	<b>EK-ME1-06T</b>	237
640 mA bus power supply	<b>EK-AB1-TP</b>	183
640 mA bus power supply with 30 Vdc auxiliary output	<b>EK-AG1-TP</b>	183
6-fold pushbutton - FF series - blue / green led	<b>EK-EH2-TP</b>	48
6-fold pushbutton - FF series- red / white led	<b>EK-EH2-TP-RW</b>	48
80 A MID single phase energy meter	<b>EK-ME1-80M</b>	236
80 A MID three phase energy meter	<b>EK-ME1-80T</b>	238
8-fold actuator / controller for electrothermal valve drives	<b>EK-HE1-TP</b>	219
8-fold binary input	<b>EK-CA1-TP</b>	198
8-fold binary output	<b>EK-FB1-TP</b>	201
8-fold binary output/4-fold blind actuator	<b>EK-FE1-TP</b>	202
8-fold pushbutton with backlit text/symbols and proximity sensor - 20venti series	<b>EK-E20-TP-8T-P</b>	28
8-fold pushbutton with backlit text/symbols and proximity sensor for rectangular wall-box - 20venti series	<b>EK-E20-TP-8T-P-R</b>	29
Adapter for card holder and card reader	<b>EK-SP-TX2</b>	100
Adapter for card holder and card reader	<b>EK-SP-TX2</b>	100
Adapter for Deep double plate	<b>EK-A71-1-NF</b>	134
Adapter for Deep double plate - Package 5 pcs.	<b>EK-A71-5-NF</b>	134

Adapter for Deep double plate - Package 5 pcs.	<b>EK-B71-5-NF</b>	137
Adapter for Deep rectangular plate	<b>EK-TAR-1-NF</b>	136
Adapter for Deep rectangular plate - Package 5 pcs.	<b>EK-TAR-5-NF</b>	136
Adapter for Deep square plate	<b>EK-TAQ-1-NF</b>	135
Adapter for Deep square plate - Package 5 pcs.	<b>EK-TAQ-5-NF</b>	135
Adapter for Deep triple plate	<b>EK-B71-1-NF</b>	138
Adapter for double plate with a Form or Flank frame	<b>EK-A71</b>	134
Adapter for double plate without frame (NF series)	<b>EK-A71-1-NF</b>	137
Adapter for double plate without frame (NF series) - Package 5 pcs.	<b>EK-A71-5-NF</b>	137
Adapter for double plate without frame (NF series) - white profile	<b>EK-A71-1-NFW</b>	134
Adapter for double plate without frame (NF series) - white profile - Package 5 pcs.	<b>EK-A71-5-NFW</b>	134
Adapter for rectangular plate with a Form or Flank frame	<b>EK-TAR</b>	133
Adapter for rectangular plate without frame (NF series)	<b>EK-TAR-1-NF</b>	133
Adapter for rectangular plate without frame (NF series) - Package 5 pcs.	<b>EK-TAR-5-NF</b>	133
Adapter for rectangular plate without frame (NF series) - white profile	<b>EK-TAR-1-NFW</b>	133
Adapter for rectangular plate without frame (NF series) - white profile - Package 5 pcs.	<b>EK-TAR-5-NFW</b>	133
Adapter for square plate with a Form or Flank frame	<b>EK-TAQ</b>	132
Adapter for square plate without frame (NF series)	<b>EK-TAQ-1-NF</b>	132
Adapter for square plate without frame (NF series) - Package 5 pcs.	<b>EK-TAQ-5-NF</b>	132
Adapter for square plate without frame (NF series) - white profile	<b>EK-TAQ-1-NFW</b>	132
Adapter for square plate without frame (NF series) - white profile - Package 5 pcs.	<b>EK-TAQ-5-NFW</b>	132
Adapter for Surface double plate	<b>EK-TAS-D-1</b>	141
Adapter for Surface double plate - Package 5 pcs.	<b>EK-TAS-D-5</b>	141
Adapter for Surface rectangular plate	<b>EK-TAS-R-1</b>	140
Adapter for Surface square plate	<b>EK-TAS-Q-1</b>	139
Adapter for Surface square plate - Package 5 pcs.	<b>EK-TAS-Q-5</b>	139
Adapter for Surface square plate - Package 5 pcs.	<b>EK-TAS-R-5</b>	140
Additional license for Tosibox® Key with 1 mobile client	<b>EK-DEL-TBMC1</b>	107
Additional license for Tosibox® Key with 10 mobile client	<b>EK-DEL-TBMC10</b>	107
Additional license for Tosibox® Key with 5 mobile client	<b>EK-DEL-TBMC5</b>	107
Aluminium frame for Delégo panel 5"	<b>EK-DEL-5FR-...</b>	251
Bus cable - bus connection	<b>EK-112-TP</b>	241
Bus cable - bus connection and spare pair	<b>EK-114-TP</b>	241
Card holder	<b>EK-TH2-TP</b>	103
Card reader	<b>EK-TR2-TP</b>	102

## Index by description

Cards programmer	<b>EK-TP2-TP</b>	104
Client License for additional programming workstation	<b>EK-ACC-LC</b>	105
Color Box Pro - Fenix NTM®	<b>EK-CBP-NTM</b>	259
Color Box Pro - Plastic and Metal	<b>EK-CBP-PLA-MET</b>	259
Color Ring - Fenix NTM®	<b>EK-CC-FEN</b>	258
Color Ring - Metal	<b>EK-CC-MET</b>	258
Color Ring - Plastic	<b>EK-CC-PLA</b>	258
Configurable logical module	<b>EK-LM2-TP</b>	190
ConMasterNet with integrated KNX module	<b>EK-BQ1-TP</b>	232
Current transformer (TA) for EK-CF2-TP interface - 0...5	<b>EK-TA-05A</b>	195
Current transformer (TA) for EK-CF2-TP interface - 0...50	<b>EK-TA-50A</b>	195
Current transformer (TA) for EK-CF2-TP interface - 0...20	<b>EK-TA-20A</b>	195
Current transformer (TA) for EK-CF2-TP interface - 0...30	<b>EK-TA-30A</b>	195
Current transformer (TA) for EK-CF2-TP interface - 0...40	<b>EK-TA-40A</b>	195
Current transformer (TA) for EK-CF2-TP interface - 0...60	<b>EK-TA-60A</b>	195
Deep double plate - window 45 x 45 mm (1) - window 60 x 60 mm (1)	<b>EK-D2F</b>	137
Deep double plate - window 45 x 45 mm (2)	<b>EK-D2E</b>	137
Deep double plate - window 55 x 55 mm (1) - window 60 x 60 mm (1)	<b>EK-D2G-...</b>	137
Deep double plate - window 55 x 55 mm (2)	<b>EK-D2P-...</b>	137
Deep double plate - window 60 x 60 mm (2)	<b>EK-D2S-...</b>	137
Deep plate with 120 x 60 mm window	<b>EK-D2C-...</b>	146
Deep rectangular plate - window 60 x 60 mm	<b>EK-DRS-...</b>	136
Deep rectangular plate - window 68 x 45 mm	<b>EK-DRG-...</b>	136
Deep square plate - window 30 x 60 mm	<b>EK-DQT-...</b>	135
Deep square plate - window 45 x 45 mm	<b>EK-DQP-...</b>	135
Deep square plate - window 55 x 55 mm	<b>EK-DQG-...</b>	135
Deep square plate - window 60 x 60 mm	<b>EK-DQS-...</b>	135
Deep triple plate - window 55 x 55 mm (3)	<b>EK-D3P-...</b>	138
Deep triple plate - window 60 x 60 mm (3)	<b>EK-D3S-...</b>	138
Delégo panel 5" - black panel	<b>EK-DEL-5PAN</b>	251
Delégo panel 5" - white panel	<b>EK-DEL-5PAN-WH</b>	251
Delégo panel 8" - black panel	<b>EK-DEL-8PAN</b>	251
Delégo panel 8" - white panel	<b>EK-DEL-8PAN-WH</b>	251
Delégo server - ADVANCED	<b>EK-DEL-SRV-ADV-TP</b>	250
Delégo server - BASIC	<b>EK-DEL-SRV-BAS-TP</b>	250

## Index by description

Delégo server - PREMIUM	<b>EK-DEL-SRV-PRM-TP</b>	250
Desktop cards programmer kit	<b>EK-TPBOX-TP</b>	105
Double frame - Flank series	<b>EK-FL2-...</b>	131
Double frame - Form series	<b>EK-F02-...</b>	131
Double plate - window 45 x 45 mm (1) - window 60 x 60 mm (1)	<b>EK-P2F-...</b>	134
Double plate - window 45 x 45 mm (2)	<b>EK-P2E-...</b>	134
Double plate - window 55 x 55 mm (1) - window 60 x 60 mm (1)	<b>EK-P2G-...</b>	134
Double plate - window 55 x 55 mm (2)	<b>EK-P2P-...</b>	134
Double plate - window 60 x 60 mm (2)	<b>EK-P2S-...</b>	134
Double supports for installation with 60 mm device centre distance - horizontal	<b>EK-SM2-CHD</b>	145
Double supports for installation with 60 mm device centre distance - horizontal	<b>EK-SM2-CHE</b>	145
Double supports for installation with 60 mm device centre distance - horizontal	<b>EK-SM2-CHF</b>	145
Double supports for installation with 60 mm device centre distance - vertical	<b>EK-SM2-CHA</b>	145
Double supports for installation with 60 mm device centre distance - vertical	<b>EK-SM2-CHB</b>	145
Double supports for installation with 60 mm device centre distance - vertical	<b>EK-SM2-CHC</b>	145
Easy room thermostat - FF series - mounting with square frame of Form or Flank series - blue / green led	<b>EK-ER2-TP</b>	54
Easy room thermostat - FF series - mounting with square frame of Form or Flank series - red / white led	<b>EK-ER2-TP-RW</b>	54
Easy room thermostat - FF series - mounting without frame (NF series) - blue / green led	<b>EK-ER2-TP-BG-NF</b>	54
Easy room thermostat - FF series - mounting without frame (NF series) - blue / green led - white profile	<b>EK-ER2-TP-BG-NFW</b>	54
Easy room thermostat - FF series - mounting without frame (NF series) - red / white led	<b>EK-ER2-TP-RW-NF</b>	54
Easy room thermostat - FF series - mounting without frame (NF series) - red / white led - white profile	<b>EK-ER2-TP-RW-NFW</b>	54
Fancoil actuator / controller 0-10 V fan control	<b>EK-HB1-TP</b>	217
Fancoil actuator / controller 3-speed fan control	<b>EK-HA1-TP</b>	216
Fancoil actuator / controller full version	<b>EK-HC1-TP</b>	218
Full front cover for Multisensor EK-ES2-TP - 71 Series	<b>EK-T1Q-...-ES2</b>	114
Full front cover for Multisensor EK-ET2-TP - 71 Series	<b>EK-T1Q-...-ET2</b>	114
Gateway BACnet - KNX	<b>EK-BJ1-TP-IP</b>	226
Gateway DALI - KNX	<b>EK-BG1-TP</b>	230
Gateway DMX - KNX	<b>EK-BJ1-TP-MSTP</b>	226
Gateway M-Bus - KNX	<b>EK-BK1-TP</b>	227
Gateway Modbus RS485 - KNX	<b>EK-BH1-TP-485</b>	224
Gateway Modbus TCP/IP - KNX	<b>EK-BH1-TP-TCP</b>	225
Gateway PROFINET - KNX	<b>EK-BN1-TP</b>	229
Gateway PROFINET - KNX - max 160 slave devices	<b>EK-BM1-TP-160</b>	228

Gateway PROFINET - KNX - max 20 slave devices	<b>EK-BM1-TP-20</b>	228
Gateway PROFINET - KNX - max 40 slave devices	<b>EK-BM1-TP-40</b>	228
Gateway PROFINET - KNX - max 80 slave devices	<b>EK-BM1-TP-80</b>	228
GPS Module	<b>EK-GPS-1</b>	184
Input/output module for hotel applications	<b>EK-H01-TP</b>	206
Input/output module for office applications	<b>EK-HU1-TP</b>	205
IP interface and IP router	<b>EK-BB1-TP</b>	187
IP interface and IP router	<b>EK-BC1-TP</b>	188
IR Remote Controller (presence sensors)	<b>EK-QR6-IR</b>	67-68-69
Kit with network analyzer and Rogowski coils - 3 Rogowski coils 30 cm length	<b>EK-MEK-30</b>	235
Kit with network analyzer and Rogowski coils - 3 Rogowski coils 45 cm length	<b>EK-MEK-45</b>	235
Kit with network analyzer and Rogowski coils - 3 Rogowski coils 70 cm length	<b>EK-MEK-70</b>	235
KNX communication module	<b>EK-MC1-TP</b>	240
Line / area coupler	<b>EK-BA1-TP</b>	176
Load monitoring and control interface	<b>EK-CF2-TP</b>	194
Mixing actuator	<b>EK-HH1-TP</b>	220
Modbus / KNX interface for RDZ air handling units	<b>EK-B01-TP-RMA</b>	222
Modbus communication module	<b>EK-MC1-MD</b>	239
Movement sensor	<b>EK-SM2-TP</b>	66
Multisensor quality air with regulator - mounting with square frame of Form or Flank series	<b>EK-ET2-TP</b>	96
Multisensor quality air with regulator - mounting without frame (NF series)	<b>EK-ET2-TP-NF</b>	96
Multisensor quality air with regulator - mounting without frame (NF series) - white profile	<b>EK-ET2-TP-NFW</b>	96
Multisensor quality air with regulator for rectangular wall-box - mounting with square frame of Form or Flank series	<b>EK-ET2-TP-R</b>	97
Multisensor quality air with regulator for rectangular wall-box - mounting without frame (NF series)	<b>EK-ET2-TP-NF-R</b>	97
Multisensor quality air with regulator for rectangular wall-box - mounting without frame (NF series) - white profile	<b>EK-ET2-TP-NFW-R</b>	97
Multisensor with humidity, TVOC and CO2 eq. regulator - mounting with square frame of Form or Flank series	<b>EK-ES2-TP</b>	98
Multisensor with humidity, TVOC and CO2 eq. regulator - mounting without frame (NF series)	<b>EK-ES2-TP-NF</b>	98
Multisensor with humidity, TVOC and CO2 eq. regulator - mounting without frame (NF series) - white profile	<b>EK-ES2-TP-NFW</b>	98
Multisensor with humidity, TVOC and CO2 eq. regulator for rectangular wall-box - mounting with square frame of Form or Flank series	<b>EK-ES2-TP-R</b>	99
Multisensor with humidity, TVOC and CO2 eq. regulator for rectangular wall-box - mounting without frame (NF series)	<b>EK-ES2-TP-NF-R</b>	99
Multisensor with humidity, TVOC and CO2 eq. regulator for rectangular wall-box - mounting without frame (NF series) - white profile	<b>EK-ES2-TP-NFW-R</b>	99
Network analyzer	<b>EK-ME1-MDB</b>	234
NF plate with 120 x 60 mm window	<b>EK-P2C-...</b>	146

NTC 10 kΩ temperature sensors - air mass	<b>EK-STL-10K-3435</b>	221
NTC 10 kΩ temperature sensors - contact	<b>EK-STC-10K-3435</b>	221
NTC 10 kΩ temperature sensors - immersion	<b>EK-STI-10K-3435</b>	221
NTC 10 kΩ temperature sensors - outdoor	<b>EK-STE-10K-3435</b>	221
Painted cover - Italian	<b>EK-PSC-IT-...</b>	127
Painted cover - Italian USB	<b>EK-PSC-IT-USB-...</b>	127
Painted cover - Schuko	<b>EK-PSC-DE-...</b>	128
Painted cover - Schuko USB	<b>EK-PSC-DE-USB-...</b>	128
Pocket Box	<b>EK-POC-BOX-EN</b>	258
Power socket - Italian	<b>EK-PWS-IT</b>	127
Power socket - Italian USB	<b>EK-PWS-IT-USB</b>	127
Power socket - Schuko	<b>EK-PWS-DE</b>	128
Power socket - Schuko USB	<b>EK-PWS-DE-USB</b>	128
Presence sensor for ceiling mounting	<b>EK-DG2-TP</b>	68
Presence sensor for outdoor mounting	<b>EK-DH4-TP</b>	69
Presence sensors for ceiling/counter-ceiling mounting	<b>EK-DF2-TP</b>	67
Rectangular frame - Flank series	<b>EK-FLR-...</b>	130
Rectangular frame - Form series	<b>EK-FOR-...</b>	129
Rectangular mounting support - 6-fold pushbutton and Touch&See with 2-fold pushbutton of FF series	<b>EK-SMR</b>	149
Rectangular mounting support - devices of 20venti or 71 series	<b>EK-SMR-71</b>	149
Rectangular plate - window 45 x 45 mm	<b>EK-PRP-...</b>	133
Rectangular plate - window 55 x 55 mm	<b>EK-PRG-...</b>	133
Rectangular plate - window 60 x 60 mm	<b>EK-PRS</b>	133
Room thermostat - 71 series - mounting with square frame of Form or Flank series	<b>EK-E72-TP</b>	94
Room thermostat - 71 series - mounting without frame (NF series)	<b>EK-E72-TP-NF</b>	94
Room thermostat - 71 series - mounting without frame (NF series) - white profile	<b>EK-E72-TP-NFW</b>	94
Room thermostat - FF series - mounting with square frame of Form or Flank series - blue / green led	<b>EK-EP2-TP</b>	55
Room thermostat - FF series - mounting with square frame of Form or Flank series - red / white led	<b>EK-EP2-TP-RW</b>	55
Room thermostat - FF series - mounting without frame (NF series) - blue / green led	<b>EK-EP2-TP-BG-NF</b>	55
Room thermostat - FF series - mounting without frame (NF series) - blue / green led - white profile	<b>EK-EP2-TP-BG-NFW</b>	55
Room thermostat - FF series - mounting without frame (NF series) - red / white led	<b>EK-EP2-TP-RW-NF</b>	55
Room thermostat - FF series - mounting without frame (NF series) - red / white led - white profile	<b>EK-EP2-TP-RW-NFW</b>	55
Room thermostat - FF series with relative humidity sensor - mounting with square frame of Form or Flank series - blue / green led	<b>EK-EQ2-TP</b>	56

Room thermostat - FF series with relative humidity sensor - mounting with square frame of Form or Flank series - red / white led	<b>EK-EQ2-TP-RW</b>	56
Room thermostat - FF series with relative humidity sensor - mounting without frame (NF series) - blue / green led	<b>EK-EQ2-TP-BG-NF</b>	56
Room thermostat - FF series with relative humidity sensor - mounting without frame (NF series) - blue / green led - white profile	<b>EK-EQ2-TP-BG-NFW</b>	56
Room thermostat - FF series with relative humidity sensor - mounting without frame (NF series) - red / white led	<b>EK-EQ2-TP-RW-NF</b>	56
Room thermostat - FF series with relative humidity sensor - mounting without frame (NF series) - red / white led - white profile	<b>EK-EQ2-TP-RW-NFW</b>	56
Room thermostat for rectangular wall-box - 71 series - mounting with square frame of Form or Flank series	<b>EK-E72-TP-R</b>	95
Room thermostat for rectangular wall-box - 71 series - mounting without frame (NF series)	<b>EK-E72-TP-NF-R</b>	95
Room thermostat for rectangular wall-box - 71 series - mounting without frame (NF series) - white profile	<b>EK-E72-TP-NFW-R</b>	95
Rough white cover - Italian	<b>EK-PSC-IT</b>	127
Rough white cover - Italian USB	<b>EK-PSC-IT-USB</b>	127
Rough white cover - Schuko	<b>EK-PSC-DE</b>	128
Rough white cover - Schuko USB	<b>EK-PSC-DE-USB</b>	128
Router Tosibox® Lock 150	<b>EK-DEL-TBL1</b>	106
Router Tosibox® Lock 500	<b>EK-TBL5</b>	106
Router Tosibox® Lock 500i	<b>EK-DEL-TBL5-SIM</b>	106
Set 2 square rockers for room thermostats - FF series	<b>EK-TQQ-...-EP2</b>	112
Smart-card - Client logo	<b>EK-TCC-10</b>	105
Smart-card - Ekinex logo	<b>EK-TCE-10</b>	105
Software License up to 100 reader	<b>EK-ACC-L100</b>	105
Software License up to 12 reader	<b>EK-ACC-L12</b>	105
Software License up to 200 reader	<b>EK-ACC-L200</b>	105
Software License up to 25 reader	<b>EK-ACC-L25</b>	105
Software License up to 50 reader	<b>EK-ACC-L50</b>	105
Spring for snapping on wall-mounting devices	<b>EK-MAR-1</b>	196
Spring for snapping on wall-mounting devices - Package 5 pcs.	<b>EK-MAR-5</b>	196
Square frame - Flank series	<b>EK-FLQ-...</b>	130
Square frame - Form series	<b>EK-FOQ-...</b>	129
Square mounting support - devices of 20venti or 71 series and 4-fold pushbutton of FF series	<b>EK-SMQ-71</b>	149
Square mounting support - thermostats and Touch&See FF series	<b>EK-SMQ</b>	149
Square plate - window 45 x 45 mm	<b>EK-PQP-...</b>	132
Square plate - window 55 x 55 mm	<b>EK-PQG-...</b>	132
Square plate - window 60 x 60 mm	<b>EK-PQS-...</b>	132
Square rockers for 6-fold pushbuttons and Touch&See - FF series	<b>EK-TQQ-...</b>	111
Style box 20venti series	<b>EK-SB4-20VENTI</b>	260
Style box 71 series - Deep	<b>EK-SB4-71-DEEP</b>	260



## Index by description

Style box 71 series - Surface	<b>EK-SB4-71-SURFACE</b>	260
Style box Delégo panel 5"	<b>EK-SB4-SPAN</b>	260
Style box FF series - Form	<b>EK-SB4-FF-FORM</b>	260
Style Case	<b>EK-SC1-01</b>	260
Support for DIN-rail mounting	<b>EK-SMG-35-1</b>	196
Support for DIN-rail mounting - Package 5 pcs.	<b>EK-SMG-35-5</b>	196
Support for external mounting (presence sensors)	<b>EK-QS3</b>	67-68-69
Surface double plate - window 45 x 45 mm (1) - window 60 x 60 mm (1)	<b>EK-S2F</b>	141
Surface double plate - window 45 x 45 mm (2)	<b>EK-S2E</b>	141
Surface double plate - window 55 x 55 mm (1) - window 60 x 60 mm (1)	<b>EK-S2G-...</b>	141
Surface double plate - window 55 x 55 mm (2)	<b>EK-S2P-...</b>	141
Surface double plate - window 60 x 60 mm (2)	<b>EK-S2S-...</b>	141
Surface plate with 120 x 60 mm window	<b>EK-S2C-...</b>	147
Surface rectangular plate - window 60 x 60 mm	<b>EK-SRS</b>	140
Surface rectangular plate - window 68 x 45 mm	<b>EK-SRG-...</b>	140
Surface square plate - window 30 x 60 mm	<b>EK-SQT-...</b>	139
Surface square plate - window 45 x 45 mm	<b>EK-SQP-...</b>	139
Surface square plate - window 55 x 55 mm	<b>EK-SQG-...</b>	139
Surface square plate - window 60 x 60 mm	<b>EK-SQS-...</b>	139
Tech Case advanced version	<b>EK-TCA-TP</b>	261
Tech Case basic version	<b>EK-TCB-TP</b>	261
Template for side-by-side mounting of FF series with Flank frames	<b>EK-DFL</b>	150
Template for side-by-side mounting of FF series with Form frames	<b>EK-DFO</b>	150
Template for Surface plates - devices of 71 series	<b>EK-DPS-D-1</b>	142
Template for Surface plates - devices of 71 series - Package 5 pcs.	<b>EK-DPS-D-5</b>	142
Template for Surface plates - standard flush-mounted inserts	<b>EK-DPS-Q-1</b>	142
Template for Surface plates - standard flush-mounted inserts	<b>EK-DPS-R-1</b>	142
Template for Surface plates - standard flush-mounted inserts - Package 5 pcs.	<b>EK-DPS-Q-5</b>	142
Template for Surface plates - standard flush-mounted inserts - Package 5 pcs.	<b>EK-DPS-R-5</b>	142
Terminal blocks - red/black - bus connection	<b>EK-MNR-TP</b>	241
Terminal blocks - yellow/white - SELV connection	<b>EK-MGB-TP</b>	241
Time / astronomical digital switch	<b>EK-TM1-TP</b>	184
Tosibox® Key cryptographic micro-controller that realizes 1 client PC + 1 mobile client	<b>EK-DEL-TBK1</b>	108
Tosibox® SoftKey software key to be combined with a key, with Sub Key function	<b>EK-DEL-TBSK1</b>	107
Touch&See display - mounting with square frame of Form or Flank series	<b>EK-EC2-TP</b>	62

Touch&See display - mounting without frame (*NF Series)	<b>EK-EC2-TP-00-NF</b>	62
Touch&See display - mounting without frame (*NF Series) - white profile	<b>EK-EC2-TP-00-NFW</b>	62
Touch&See display with 2-fold pushbutton - mounting with square frame of Form or Flank series - blue / green led	<b>EK-EF2-TP</b>	63
Touch&See display with 2-fold pushbutton - mounting with square frame of Form or Flank series - red / white led	<b>EK-EF2-TP-RW</b>	63
Universal interface 2 IN, 2 OUT	<b>EK-CC2-TP</b>	191
Universal interface 4 configurable IN, 4 OUT	<b>EK-CG2-TP</b>	192
Universal interface 4 IN, 2 OUT (relay 5A)	<b>EK-CE2-TP</b>	193
Universal interface 4 IN, 4 OUT	<b>EK-CD2-TP</b>	191
Upgrade server Delégo ADVANCED-PREMIUM	<b>EK-DEL-UP-GR-AP</b>	250
Upgrade server Delégo BASIC-ADVANCED	<b>EK-DEL-UP-GR-BA</b>	250
Upgrade server Delégo BASIC-PREMIUM	<b>EK-DEL-UP-GR-BP</b>	250
USB interface	<b>EK-BD1-TP</b>	185
Voice control interface - KNX	<b>EK-BW1-TP</b>	231
Voucher to enable the module Intrusion detection	<b>EK-DEL-V1-INTRDET</b>	250
Voucher to enable the module Modbus (> 30 registers)	<b>EK-DEL-V1-MODBUS</b>	250
Voucher to enable the module IP video intercom	<b>EK-DEL-V1-VOIP</b>	250

## Contacts

### EKINEX S.p.A.

Via Novara, 37

I-28010 Vaprio d'Agogna NO - ITALY

T +39 0321 1828980

info@ekinex.com

www.ekinex.com



**Ekinex® product catalogue - December 2021**

The technical information included in this catalogue is to be deemed purely indicative.  
The company reserves the right to modify any piece of information with no advance notice.

For installation, connection and commissioning of Ekinex® devices, please refer to the related technical documentation.

For the availability of Ekinex® products on your market, please contact the Ekinex® sales department (sales@ekinex.com).

© EKINEX S.p.A. 2021. The reproduction of any part of this catalog requires prior written consent of Ekinex S.p.A

**Credits**

Art direction	Marketing & Communication Ekinex®
Graphic Design	Marketing & Communication Ekinex®
Product development	R&D Ekinex®
Editing	R&D Ekinex®
Print	Tipolitografia Testori Snc
Photos	Architecture intérieure: agence Superstane, Lille (FR). Photo © Stéphane Waroczyk, 2019 Giorgio Possenti Vito Corvasce



[www.ekinex.com](http://www.ekinex.com)